

Panasonic

Digital Super Hybrid System

User Manual

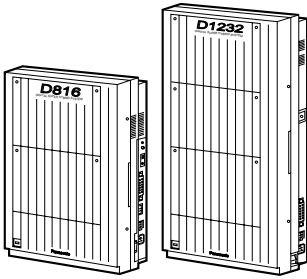

KX-TD816NZ

Model No. KX-TD1232NZ



Please read this manual before using the Digital Super Hybrid System.

Thank you for purchasing the Panasonic Digital Super Hybrid System.

Telephones

This system can connect digital and analogue Panasonic proprietary telephones. Single line devices such as a single line telephone, facsimile, cordless telephone, voice processing system, etc. can also be connected.

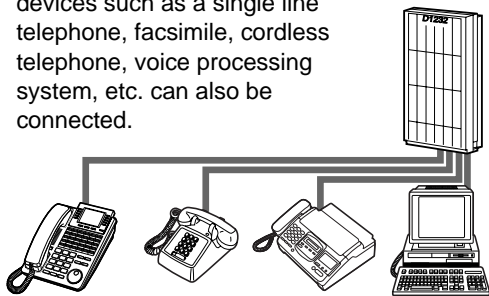

1.3.1 Connection Example

More Extensions

This system can double the extension capacity by connecting a proprietary telephone and a single line telephone. The proprietary telephone can share the extension with another single line telephone. Furthermore, you can connect a Panasonic digital proprietary telephone and a single line telephone to one jack and use them as individual extensions.

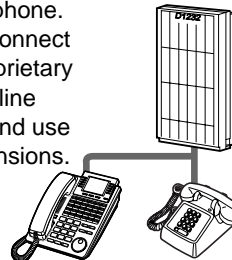

1.4.1 Adding Another Telephone in Parallel

**Saves on telephone charges
(Automatic Route Selection)**

This system chooses the most cost-effective carrier based on the outside number dialed and the time called.

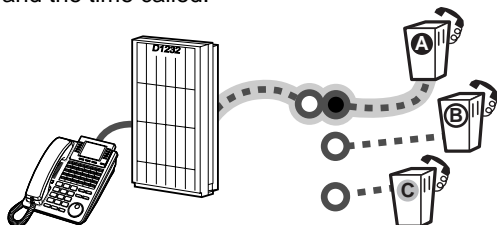

Page 27

**Call Record
(Station Message Detail Recording)**

This system can record or print out call information: date, time, extension no., dialed no., duration, etc.

Date	Time	Ext
06/24/99	10:03AM	123
06/24/99	11:07AM	223

Consult your dealer

DECT System

This system optionally supports the DECT system. A DECT Portable Station (PS) can be used in the system with other wired telephone.

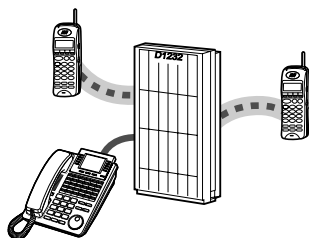

DECT Portable Station

Voice Mail Integration

You can forward your call to a voice processing system and let callers leave their messages in your mailbox when you are unable to receive calls.

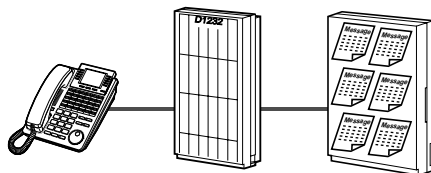

2.8.3 If a Voice Processing System is Connected

Note

In this manual, the suffix of each model number is omitted.

Important Information

WARNING

THIS UNIT MAY ONLY BE INSTALLED AND SERVICED BY QUALIFIED SERVICE PERSONNEL. WHEN A FAILURE OCCURS WHICH RESULTS IN THE INTERNAL PARTS BECOMING ACCESSIBLE, DISCONNECT THE POWER SUPPLY CORD IMMEDIATELY AND RETURN THIS UNIT TO YOUR DEALER.

DISCONNECT THE TELECOM CONNECTION BEFORE DISCONNECTING THE POWER CONNECTION PRIOR TO RELOCATING THE EQUIPMENT, AND RECONNECT THE POWER FIRST.

THIS UNIT IS EQUIPPED WITH AN EARTHING CONTACT PLUG. FOR SAFETY REASONS THIS PLUG MUST ONLY BE CONNECTED TO AN EARTHING CONTACT SOCKET WHICH HAS BEEN INSTALLED ACCORDING TO REGULATIONS.

THE POWER SUPPLY CORD IS USED AS THE MAIN DISCONNECT DEVICE. ENSURE THAT THE SOCKET-OUTLET IS LOCATED/INSTALLED NEAR THE EQUIPMENT AND IS EASILY ACCESSIBLE.

TO PREVENT FIRE OR SHOCK HAZARD, DO NOT EXPOSE THIS PRODUCT TO RAIN OR MOISTURE.

WARNING

Static sensitive devices are used. To protect printed circuit boards from static electricity, do not touch connectors indicated to the right. To discharge body static, touch ground or wear a grounding strap.

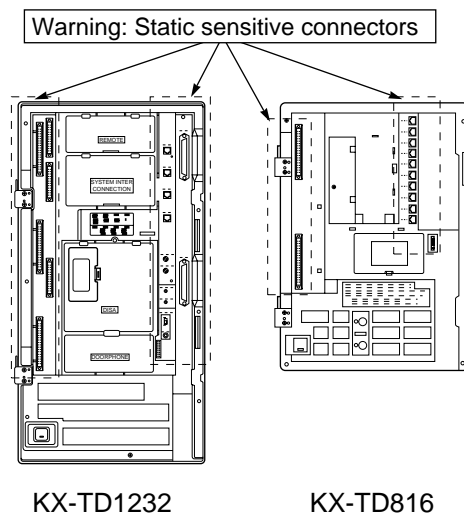

The following icons are used frequently in this manual.



Safety Instructions

When using your telephone equipment, basic safety precautions should always be followed to reduce the risk of fire, electric shock and injury to persons, including the following:

- 1.** Do not use this product near water, for example, near a bath tub, wash bowl, kitchen sink or laundry tub, in a wet basement or near a swimming pool.
- 2.** Avoid using a telephone (other than a cordless type) during an electric storm. There may be a remote risk of electric shock from lightning.
- 3.** Do not use the telephone to report a gas leak in the vicinity of the leak.
- 4.** Use only the power cord and batteries indicated in this manual. Do not dispose of batteries in a fire. They may explode. Check with local codes for possible special disposal instructions.

SAVE THESE INSTRUCTIONS

Attention

- Keep the unit away from heating appliances and electrical noise generating devices such as fluorescent lamps, motors and televisions. These noise sources can interfere with the performance of the unit.
- This unit should be kept free of dust, moisture, high temperature (more than 40°C) and vibration, and should not be exposed to direct sunlight.
- Never attempt to insert wires, pins, etc., into the vents or holes of this unit.
- If there is any trouble, disconnect the unit from the telephone line. Plug the telephone directly into the telephone line. If the telephone operates properly, do not reconnect the unit to the line until the problem has been repaired by an authorised Panasonic Factory Service Centre. If the telephone does not operate properly, chances are that the problem is in the telephone system, and not in the unit.
- Do not use benzine, thinner, or any abrasive powder to clean the cabinet. Wipe it with a soft cloth.

The serial number of this product may be found on the label affixed to the unit. You should note the model number and the serial number of this unit in the space provided and retain this manual as a permanent record of your purchase, to aid in identification in the event of theft.

MODEL NO.: _____

SERIAL NO.: _____

For your future reference

Serial No. _____

(Found on the bottom of the unit)

DATE OF PURCHASE _____

NAME OF DEALER _____

DEALER'S ADDRESS _____

DEALER'S TELEPHONE NO. _____

Table of Contents

1 Overview

1.1 Capacity	10
1.1.1 Capacity	10
1.2 Names and Locations	11
1.2.1 Names and Locations	11
1.3 Connection Example	13
1.3.1 Connection Example	13
1.4 Adding Another Telephone in Parallel	14
1.4.1 Adding Another Telephone in Parallel	14

2 Operation

2.1 Before Operating the Telephones	18
2.1.1 Before Operating the Telephones	18
2.2 Making Calls	25
2.2.1 Basic Calling	25
2.2.2 Easy Dialling	28
2.2.3 Redial	33
2.2.4 When the Dialed Line is Busy or There is No Answer	35
2.2.5 Calling without Restrictions	40
2.2.6 Accessing the ISDN Network Service (ISDN Network Service Access)	42
2.2.7 Alternating the Calling Method (Alternate Calling — Ring / Voice)	43
2.2.8 To Access Another Party Directly from Outside (Direct Inward System Access [DISA])	44
2.3 Receiving Calls	46
2.3.1 Answering Calls.....	46
2.3.2 Answering Hands-free (Hands-free Answerback)	48
2.3.3 Answering a Call Ringing at Another Telephone (Call Pickup).....	49
2.3.4 Answering a Call via an External Speaker (Trunk Answer From Any Station [TAFAS])	51
2.4 During a Conversation	52
2.4.1 Holding a Call	52
2.4.2 Talking to Two Parties Alternately (Call Splitting)	57
2.4.3 Transferring a Call	58
2.4.4 Answering a Call Waiting.....	60
2.4.5 Three-party Conversation	62
2.4.6 Mute	65
2.4.7 Letting Other People Listen to the Conversation (Off-Hook Monitor) [KX-T7433, KX-T7436 only].....	66
2.5 Before Leaving Your Desk	67
2.5.1 Forwarding Your Calls (Call Forwarding)	67
2.5.2 Showing an Absent Message on the Caller's Telephone Display (Absent Message Capability)	
72	
2.5.3 Preventing Other People from Using Your Telephone (Electronic Station Lockout).....	75
2.5.4 Leaving a Call Distribution Group (Log-In / Log-Out)	76

2.6 Making / Answering an Announcement.....	78
2.6.1 Paging.....	78
2.6.2 Paging a Person and Transferring a Call.....	81
2.6.3 Answering a Paged Announcement.....	83
2.7 Setting the Telephone According to Your Needs.....	85
2.7.1 Setting the Alarm (Timed Reminder).....	85
2.7.2 Refusing Incoming Calls (Do Not Disturb [DND]).....	87
2.7.3 Receiving a Call Waiting (Call Waiting / Off-Hook Call Announcement [OHCA] / Whisper OHCA).....	88
2.7.4 Displaying Your Number on the Called Party and Calling Party's Telephone (Calling / Connected Line Identification Presentation [CLIP / COLP]).....	89
2.7.5 Denying Other People the Possibility of Picking up Your Calls (Call Pickup Deny).....	90
2.7.6 Denying Other People the Possibility of Joining Your Conversation (Executive Busy Override Deny).....	91
2.7.7 Turning on the Background Music.....	92
2.7.8 Protecting Your Line against Indication Tones (Data Line Security).....	93
2.7.9 Checking the Day / Night Service Status.....	94
2.7.10 Setting the Parallel Connected Telephone Ringer (Paralleled Telephone).....	95
2.7.11 Clearing the Feature Settings at Your Extension (Station Programme Clear).....	96
2.8 Using User-supplied Equipment.....	97
2.8.1 If a Doorphone / Door Opener is Connected.....	97
2.8.2 If a Host PBX is Connected.....	99
2.8.3 If a Voice Processing System is Connected.....	100
2.9 Using the Display Proprietary Telephone.....	107
2.9.1 Calling Using the Call Log (Incoming Call Log) [KX-T7433, KX-T7436, KX-T7230, KX-T7235 only].....	107
2.9.2 Recording a Call Log [KX-T7433, KX-T7436, KX-T7230, KX-T7235 only].....	109
2.9.3 Denying Other People the Possibility of Seeing Your Call Log (Incoming Call Log Lock) [KX-T7433, KX-T7436, KX-T7230, KX-T7235 only].....	110
2.9.4 Using the KX-T7433, KX-T7436 or KX-T7235.....	111

3 Operator Operation

3.1 Extension Control.....	124
3.1.1 Changing the Settings.....	124
3.2 System Control.....	125
3.2.1 Day / Night Service.....	125
3.2.2 Turning on the External Background Music.....	127
3.2.3 Recording Outgoing Messages.....	128
3.2.4 Using the ANSWER / RELEASE Button [KX-T7441 only].....	131
3.2.5 Hotel Use Features [KX-T7436, KX-T7235 only].....	132

4 Customising Your Phone & System

4.1 Customising Your Phone (Station Programming).....	140
4.1.1 Customising Your Phone (Station Programming).....	140
4.1.2 Initial Settings.....	141
4.1.3 Customising the Buttons.....	143
4.1.4 Charge Fee Management [Pre-assigned extension only].....	146

4.2 Customising Your System (System Programming)	147
4.2.1 Programming Information	147
4.2.2 Date and Time Set (000)	154
4.2.3 System Speed Dialling Number Set (001)	155
4.2.4 System Speed Dialling Name Set (002)	156
4.2.5 Extension Number Set (003)	163
4.2.6 Extension Name Set (004)	164

5 DECT Portable Station

5.1 Safety Instructions	168
5.1.1 Safety Instructions	168
5.2 Before Operating the DECT Portable Station	170
5.2.1 Before Operating the DECT Portable Station	170
5.3 Operation	177
5.3.1 Making Calls	177
5.3.2 Receiving Calls	180
5.3.3 Redial	181
5.3.4 Holding a Call	182
5.3.5 Transferring a Call	184
5.3.6 Using the Call Directories	185
5.3.7 Using Your PS in Parallel with the Wired Telephone (Super EXtra Device Ports [SXDP]) ..	192
5.3.8 Locking the Keypads	193
5.3.9 Selecting the Feature Button on the Display	194
5.3.10 Other Operations	195
5.4 Customising Your PS	201
5.4.1 Programming Information	201
5.4.2 PS Programming	202
5.4.3 PBX Programming	208

6 Appendix

6.1 Troubleshooting	214
6.1.1 Troubleshooting	214
6.2 Feature Number List	220
6.2.1 Feature Number List	220
6.3 Directory	223
6.3.1 Directory	223
6.4 What is This Tone?	231
6.4.1 What is This Tone?	231
6.5 Specifications	235
6.5.1 Specifications	235

Section 1

Overview

This section briefly outlines your system.

1.1 Capacity

1.1.1 Capacity

You can connect the following number of extensions and outside lines to your system.

	Basic System	With optional units	System Connection
KX-TD816			
Outside line	4	8	—
Extension	8	16	—
KX-TD1232			
Outside line	8	12	24
Extension	16	32	64

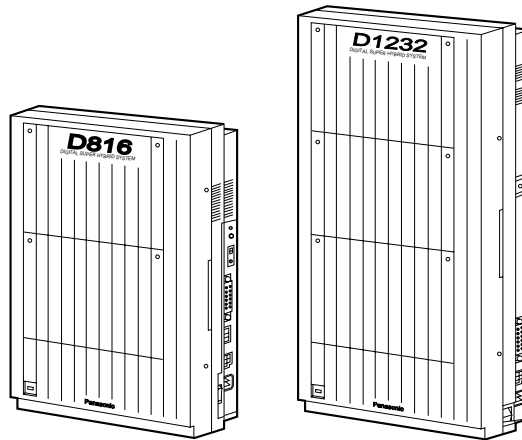

1.2 Names and Locations

1.2.1 Names and Locations

KX-TD816

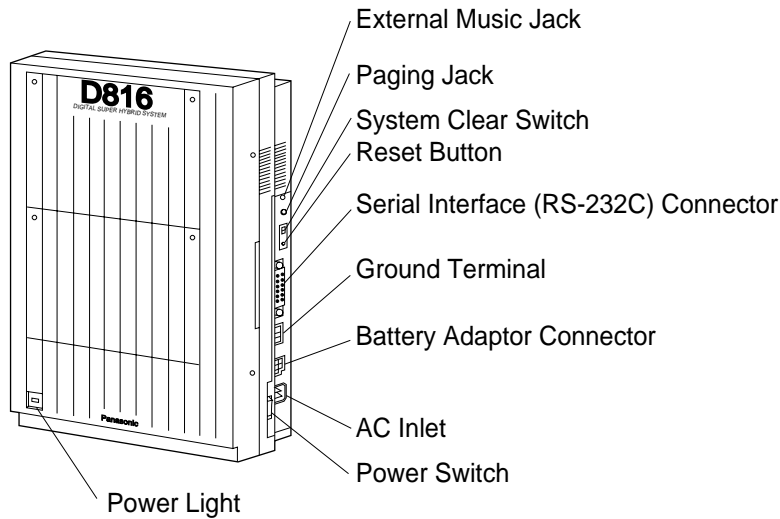

KX-TD1232

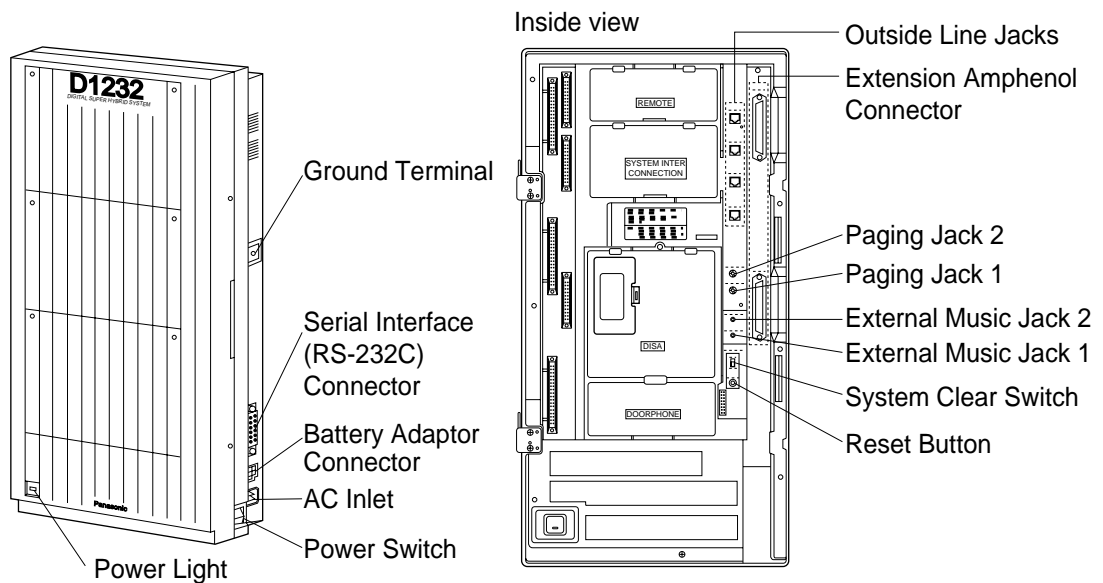

To open the front cover

1. Loosen the two screws on the right side of the main unit.
The two screws are attached to the front cover with springs so that they will not be lost.
2. Open the front cover in the direction of arrow (A).

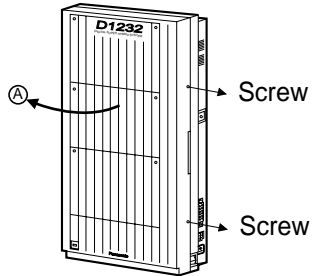

To close the front cover

1. Reverse the steps above.

1.3 Connection Example

1.3.1 Connection Example

This diagram shows you a connection example including optional equipment.

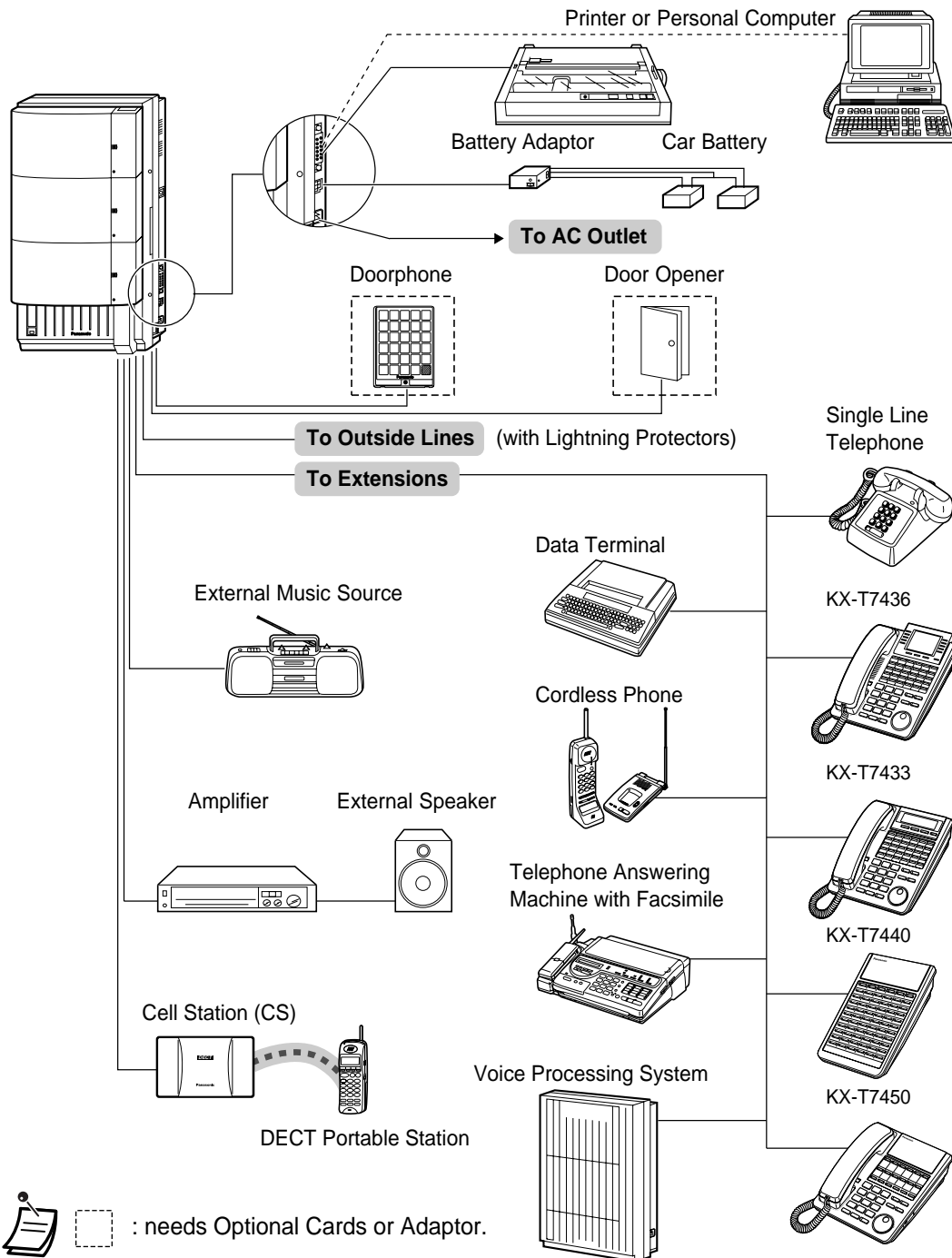

1.4 Adding Another Telephone in Parallel

1.4.1 Adding Another Telephone in Parallel

A Panasonic proprietary telephone and a single line telephone, including a facsimile, cordless telephone, etc., can be connected to one extension jack in parallel. There are two types of parallel connections.

- **Paralleled Telephone Connection**

Any proprietary telephone and a single line telephone

These telephones share the same extension number. Follow Method 1 or 2.

To ring the single line telephone, set to ring (on) if necessary. (2.7.10 Setting the Parallel Connected Telephone Ringer (Paralleled Telephone))

- **EXtra Device Port (XDP)**

Digital proprietary telephone and a single line telephone

Each telephone has a different extension number and can work individually. For more information, contact your dealer. Follow Method 2 or 3.

Method 1

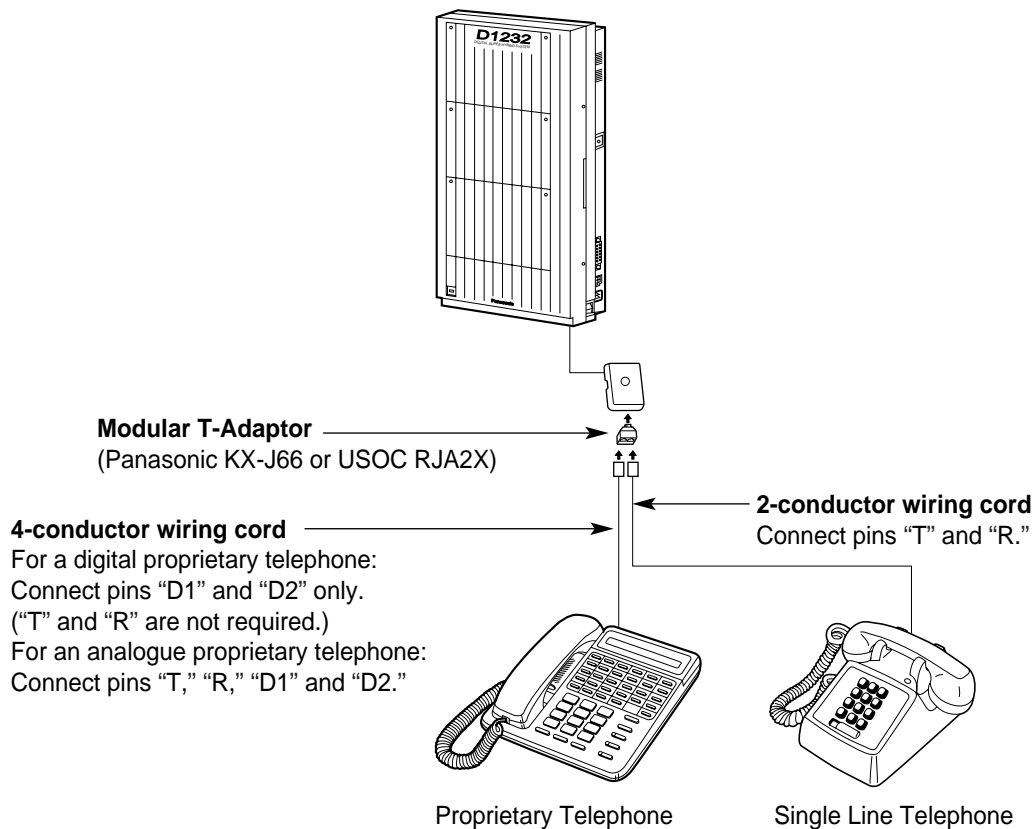

Method 2

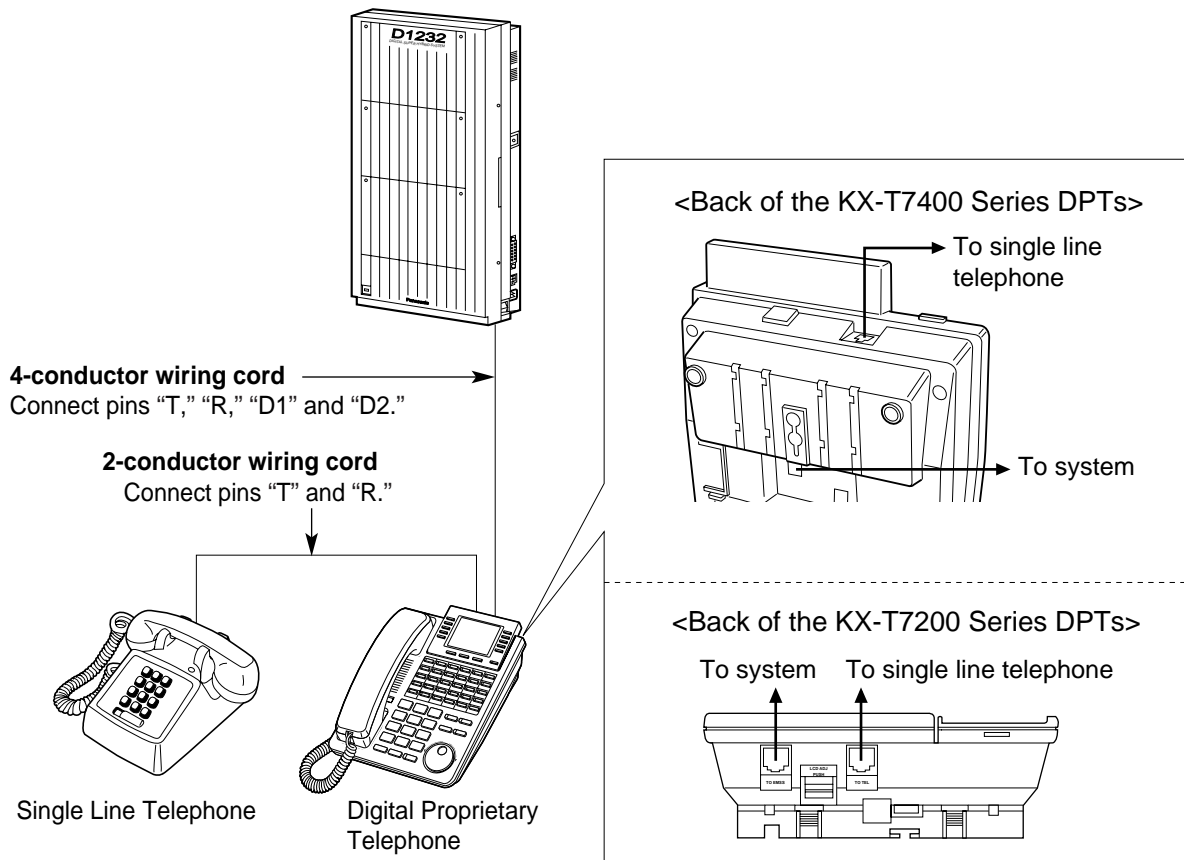

Method 3

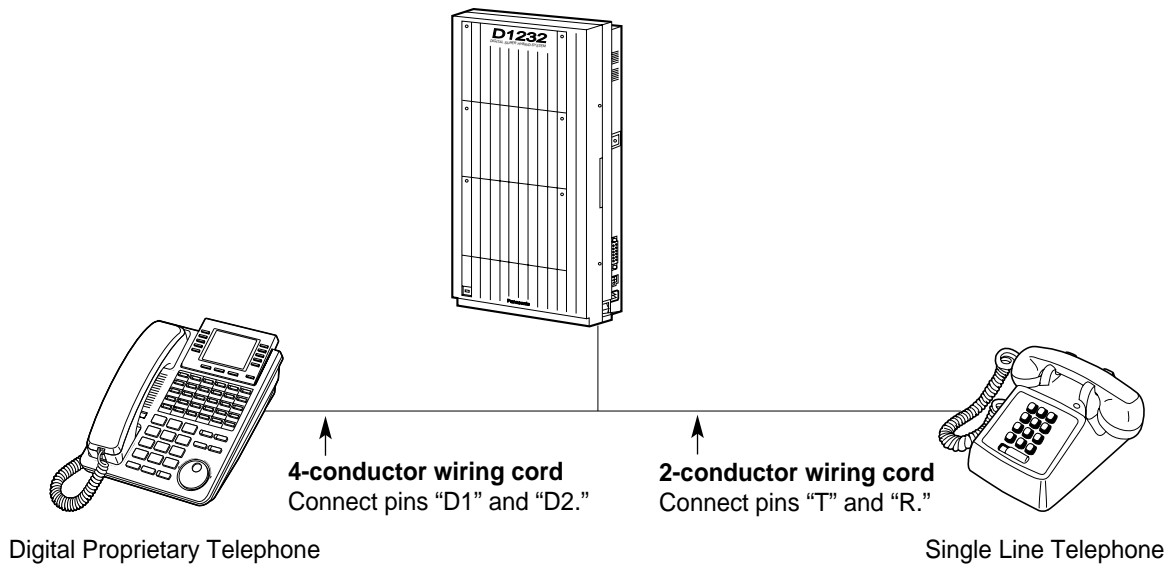

Section 2

Operation

This chapter shows you how to operate each feature step by step. Read this chapter to become familiar with the many useful features of this system.

2.1 Before Operating the Telephones

2.1.1 Before Operating the Telephones

◆◆ What kind of telephone can be used?

You can use a single line telephone (SLT), such as a rotary pulse telephone or a Panasonic proprietary telephone (PT) such as the KX-T7436. Operate the feature depending on the telephone you are using. If you are using a Panasonic proprietary telephone with a special function button such

as  and/or has a display (D – PT), you can follow the operation with the button or display messages for easy programming.

If you use a large display telephone (e.g. KX-T7436), you can follow the displayed messages to operate the features.

If your telephone does not have function buttons and/or a display, you may operate the unit by entering a feature number instead. Follow the available operation with your telephone.

If you use a Console, you can use the buttons on the Console as the buttons on the connected proprietary telephone.

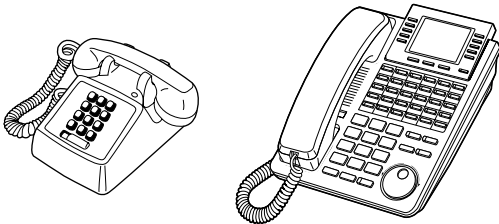

- If you use a Panasonic proprietary telephone which does not have function buttons, you may change one of the unused flexible buttons to a function button. Refer to 4.1.3 Customising the Buttons.

◆◆ Feature Numbers

To operate certain features, you need to enter specified feature numbers (and an additional parameter, if required).

There are two types of feature numbers as follows:

- Flexible feature number
- Fixed feature number

Fixed feature numbers cannot be changed. However, you can change the flexible numbers to other numbers for easier use. If you want to change the numbers, consult your dealer. In this manual, the default numbers (factory installed) are used for operations.

A flexible number is shown as  (half-shaded key). Use the new programmed number if you have changed the feature number. Write the new number in the "Feature Number List" (Appendix).



If you use a single line telephone which does not have the "*" or "#" keys; it is not possible to access features that have "*" or "#" in their feature numbers.

◆◆ Tones

You will hear various tones, during or after an operation, for confirmation. Refer to "6.4.1 What is This Tone?" (Appendix).

◆◆ Display

In this manual, you will see "the display" This refers to the display of a Panasonic proprietary telephone. If your telephone is not a Panasonic proprietary telephone with a display, the message will not be displayed.

If you use a Panasonic display proprietary telephone, the display helps you confirm the settings. For example, when you set the Do Not Disturb feature, the display shows "Do Not Disturb." Some proprietary telephones also give you easy access to operations. A message is displayed depending on the operation. By pressing the corresponding button on the side or bottom of the display, or rotating a jog dial, you can access the desired feature. For example, if turning background music on becomes available, "BGM" will be shown on the display. Follow the instructions in each operation.

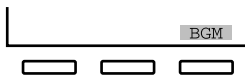

Furthermore, depending on the display proprietary telephone, you can operate features or make calls using the display message. Refer to 2.9 Using the Display Proprietary Telephone.



◆◆ Using a Jog Dial

The Jog Dial can be used for the display contrast and the volume control or you can search for desired items on the display. Rotate the Jog Dial in the either direction as desired. The contrast or the volume level and the items will change as follows:

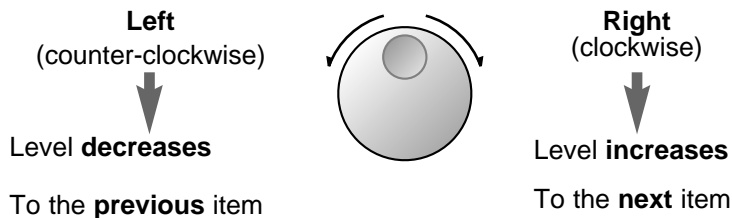

◆◆ **Your Extension Number**

If you use a Panasonic display proprietary telephone, you can check your own extension number on the display. Refer to 4.2.1 Programming Information (Customising Your Phone & System).

◆◆ **Examples**









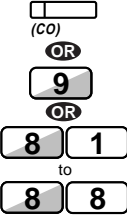

The displays and the illustrations shown as examples are from a telephone connected to the KX-TD1232.

◆◆ **Restrictions**

Some features may be restricted at your extension under system programming. Consult your manager or dealer.











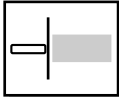





◆◆ Icon Descriptions









The following icons show you the feature availability, notes and action to operate the features. While operating the unit, you can easily refer to the Icons noted on the inside back cover of this manual.

	<p>This feature cannot be operated with a single line telephone.</p>		<p>Seize an external line (One of the following).</p> <ul style="list-style-type: none"> • Press the CO button. • Dial automatic line access number 9. • Dial outside line number 81 to 88.
	<p>Related Programming Title See "Programming," if necessary.</p>		
	<p>Off-hook (One of the following).</p> <ul style="list-style-type: none"> • Lift the handset. • Press the SP-PHONE button. • Press the MONITOR button. (To start talking, lift the handset.) 		<p>Press the Call button on the Doorphone.</p>
	<p>On-hook (One of the following).</p> <ul style="list-style-type: none"> • Hang up. • Press the SP-PHONE button. • Press the MONITOR button. 		<p>Press the hookswitch lightly.</p>
	<p>Press the corresponding function button on the proprietary telephone. (Refer to Page 22.)</p>		<p>Wait for an answer.</p>
<p>desired no.</p> <p>Enter the required number. <Example></p> <p>account code</p> <p>Enter the account code.</p>			<p>Talk.</p>
<p>extension no.</p>	<p>Dial an extension number.</p>		<p>You will hear a confirmation, dial, ring or ringback tone.</p> <p>C. Tone: confirmation tone D. Tone: dial tone R. Tone: ring tone R. B. Tone: ringback tone</p>
<p>phone no.</p>	<p>Dial the telephone number.</p>		<p>One short beep</p>

◆◆ When You Use a Panasonic Proprietary Telephone

If you use a Panasonic proprietary telephone and the Console, they may have some of the useful function buttons listed below. These buttons make operations simple. The illustrations may differ from the buttons on your telephone.

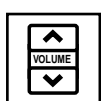
	<p>ANSWER: Used to answer an incoming call.</p>		<p>Function: <i>Located beside the display.</i> Used to perform the displayed function or operation.</p>
	<p>AUTO ANSWER / MUTE: Used to receive an incoming intercom call in the hands-free mode or mute the microphone during a conversation.</p>		<p>HOLD: Used to place a call on hold.</p>
	<p>AUTO DIAL / STORE: Used for System Speed Dialling or storing programme changes.</p>		<p>INTERCOM: Used to make or receive an intercom call.</p>
	<p>Call Forwarding / Do Not Disturb: Used to perform Call Forwarding or Do Not Disturb or change the display of an outside call information.</p>		<p>Jog Dial: Used to adjust the volume and the display contrast or select desired items for each function.</p>
	<p>CO: Used to make or receive an outside call. A Loop-CO button supports all lines. Pressing this button seizes an idle line automatically. (Button assignment is required.) Also used as the desired function buttons. (Button assignment is required.) (Only the CO "number" (e.g. 1, 2) may be shown on some telephones.)</p>		<p>MESSAGE: Used to leave a message waiting indication or call back the party who left the message waiting indication.</p>
			<p>MONITOR: Used for hands-free dialling. You can monitor the party's voice hands-free.</p>
	<p>Conference: Used to establish a three-party conversation.</p>		<p>PAUSE: Used to insert a pause during dialling. Used as the PROGRAM button if it is not equipped.</p>
	<p>DSS: Used to access the extension. (Only the "S" may be shown on some telephones.)</p>		<p>PROGRAM: Used to enter and exit the Station Programming mode.</p>
	<p>FLASH: Used to disconnect the current call and make another call without hanging up. Or used to send a flash signal to the Central Office or another connected PBX, if you programme "EFA" (External Feature Access) to the FLASH button by system programming.</p>		<p>Programmable Feature: <i>Located on the upper part of the CO button or on the Console.</i> Assigns the desired button and used to access the stored function. Mostly used as a one-touch dialling button. (Only the "F and number" may be shown on some telephones.)</p>

	REDIAL: Used to redial.		Speakerphone: Used for the hands-free operation.
	RELEASE: Used to disconnect the line.		TRANSFER: Used to transfer a call to another party.
	SAVE: Used to store a dialled phone number and redial.		VOICE CALL / MUTE: Used to monitor an intercom call automatically, but it cannot be used for hands-free conversations. It also mutes the handset microphone during a conversation.
	SHIFT: Used to access the second level of Soft Button functions.		VOLUME Control: Used to adjust the ringer and speaker volume and the display contrast.
	Soft: Used to perform a function or operation appearing on the bottom line of the display.		If the term is in parentheses like (Account) in this section, it means a flexible button has been made into an "Account" button.

◆◆ How to Follow the Steps

A sample operation is shown below.

Feature title

2.2.5 Calling Without a Restriction

◆◆ Using an account code (Account Code Entry)

An Account Code gives information about outside calls for accounting and billing purposes. You may not be able to make an outside call without an account code entry. The mode is assigned to each user. Ask your manager for your mode.

PT / SLT
ACCNT

OR

(Account)

4 9

Press "ACCNT", Account or dial 49.

account code

Enter account code
(max. 10 digits).

#

OR

9 9

Press # or dial 99.

OR

(CO)

line access no.

Press CO or enter line access number (9 or 81-88).

phone no.

Enter phone number.

Conditions

- **A Panasonic proprietary telephone user** can enter an account code during a conversation and when hearing a reorder tone after the other party hangs up.
- **If you enter the wrong code**, press the "x" key while entering the account code and then re-enter the code.
- **To cancel the entry**, press the Account button or the hookswitch while entering the code.
- **For your convenience**, you can store the code with the phone number in memory (e.g. Speed dialling).
- **If you hear a reorder tone**, the entered account code is wrong. Enter the correct code.

◆ Customising Your Phone

- **4.1.3 Customising the Buttons**
Create or re-arrange an Account button.

Hints

!! You may give a specified account code to extension users and check their telephone usage. You can specify an account code to each client and check the call duration.

Description

Operation steps

The description of the icons are explained on page 21 and the inside back cover of this manual.

Programming References:

The related or required programming is noted. To programme, see "Customising Your Phone & System."

2.2 Making Calls

2.2.1 Basic Calling

◆◆ Calling another extension

◆ To another extension (Intercom Call)

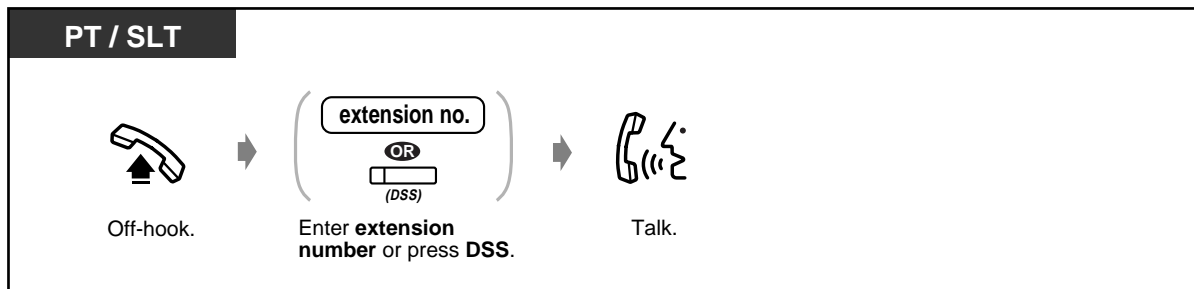

<Example>

When you call Mr. Thomas....

Mr. Thomas's extension number is 123.

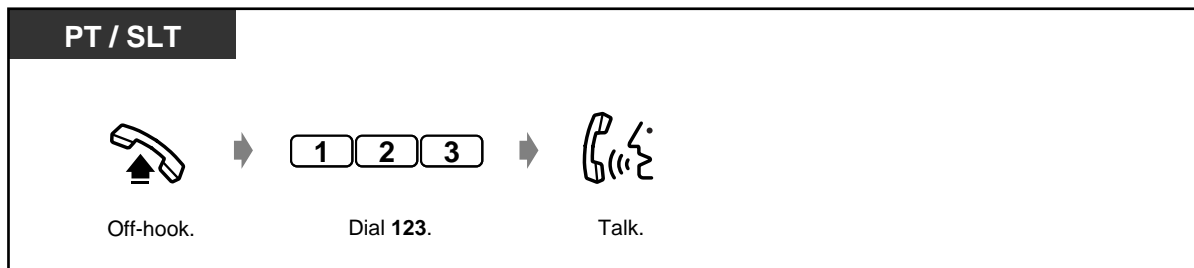

- The DSS button light shows the current status as follows:

Off: The extension is idle.

Red on: You or another extension is using the line.



- Do you have an extension directory?**

Complete the directory in 6.3.1 Directory and make a copy for your reference.

- For quick operation**

If you are an operator or dial some extensions frequently, the DSS button is useful.



Customising Your Phone

- 4.1.3 Customising the Buttons
Create or re-arrange a DSS button.

Customising Your System

- 4.2.5 Extension Number Set (003)
- 4.2.6 Extension Name Set (004)

◆ **To an operator (Operator Call)**

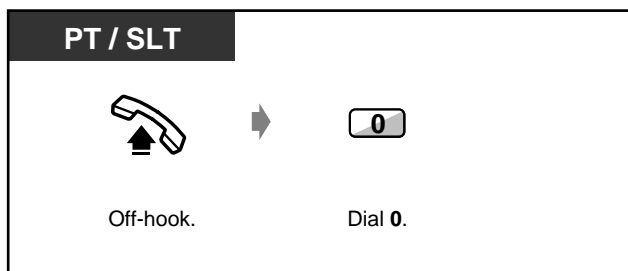

◆◆ **Calling an external party**

You have to seize an outside line before dialling an outside phone number because external calls are made via your system.

Select one of the following methods:

- Press an idle button.
- Dial automatic line access number . An idle line is selected automatically.
- Dial outside line number to .

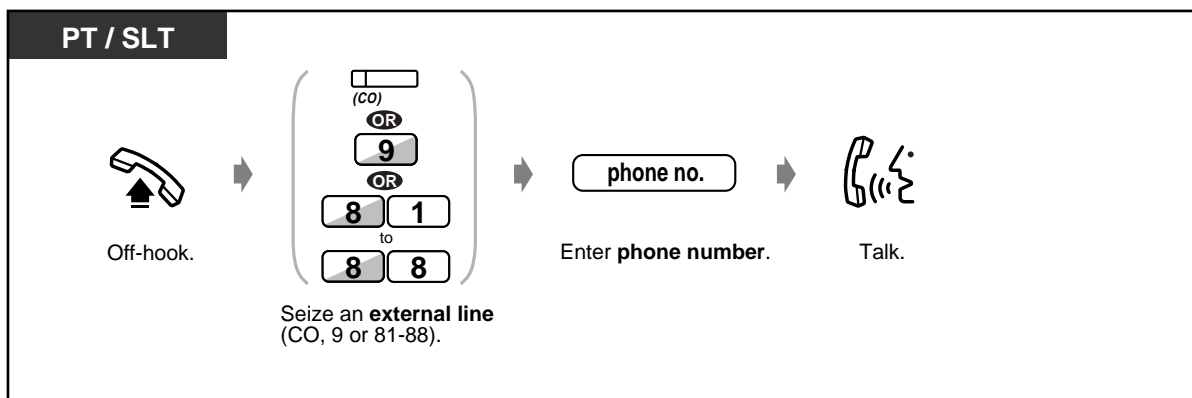

- The CO button light shows the current status as follows:
 - Off:** The line is idle.
 - Green on:** You are using the line.
 - Red on:** The line is in use.
- CO1 to CO8 correspond to outside line numbers 81 to 88 respectively.



- **Hands-free operation**

You can have a conversation in the hands-free mode using the SP-PHONE button. You can then perform other tasks at the same time.

- **Helpful hints for hands-free operation**

Use your telephone in a quiet room for best performance.

If the other party has difficulty hearing you, decrease the volume.

If you and the other party talk at the same time, parts of your conversation will be lost. To avoid this, talk alternately.

- **Emergency call**

You can dial pre-programmed emergency numbers without any restrictions.

In this case, you can make an emergency call without seizing an outside line.

- **To select the less expensive line automatically, dial "9" or press the Loop-CO button to seize a line.(Automatic Route Selection)**

- **Call information**

The following information can be referred to by repeatedly pressing the FWD/DND button as follows:

< Example >

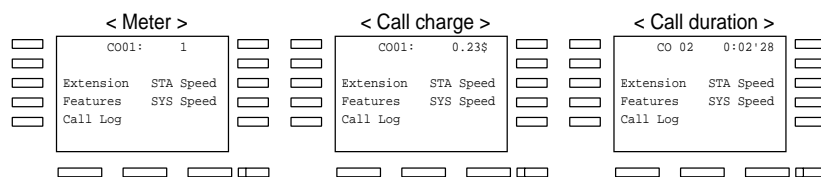

Customising Your Phone

- 4.1.2 Initial Settings—Preferred Line Assignment — Outgoing
Select the seized line when going off-hook.
- 4.1.4 Charge Fee Management [Pre-assigned extension only]

2.2.2 Easy Dialling

This is convenient for frequently dialled phone numbers.

- With one touch button
- Using numbers stored at your extension
- Using numbers stored in the system
- To a pre-set party by going off-hook
- Using a single digit number
- To a Phantom extension

◆◆ With one touch button (One-Touch Dialling)

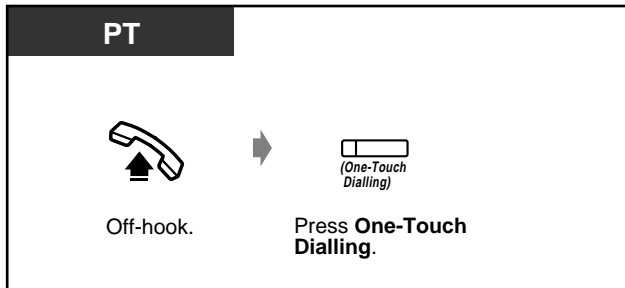

Customising Your Phone

- 4.1.2 Initial Settings—**Full One-Touch Dialling Assignment**
Allow or cancel the one-touch operation while on-hook. (Default: Allow)
- 4.1.3 Customising the Buttons
Create or re-arrange the One-Touch Dialling button and store the desired number, phone number, feature number, etc.

◆◆ Using numbers stored at your extension (Station Speed Dialling)

You can store up to ten numbers at your extension for your personal use.

◆ To store a phone number

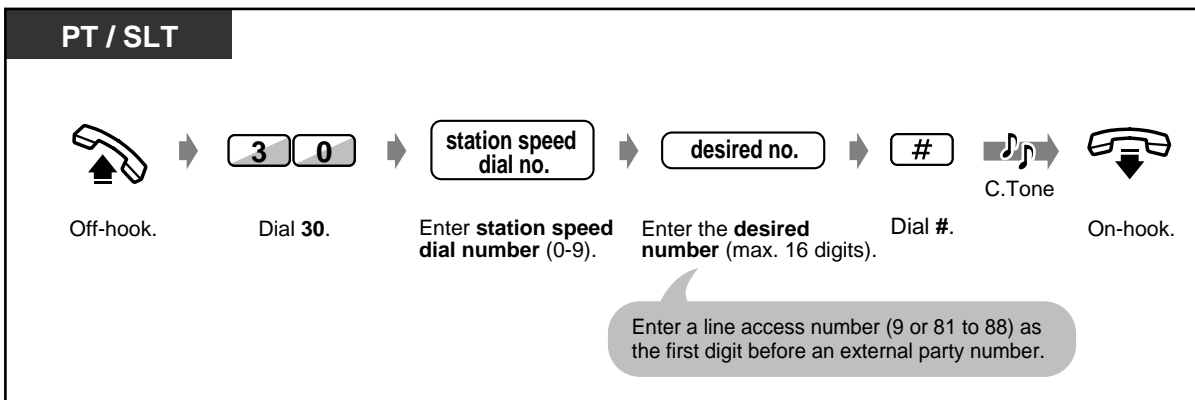

- "*" and PAUSE can also be stored as digits.

◆ To dial

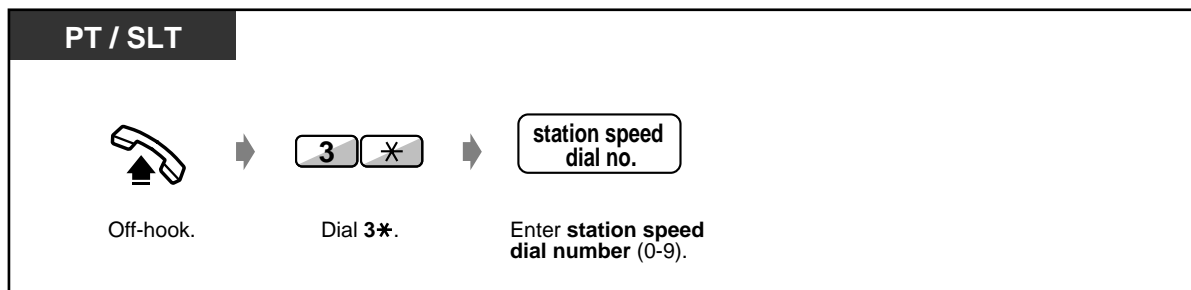

◆◆ Using numbers stored in the system (System Speed Dialling)

Up to 500 parties can be stored in the system. Refer to the directory in 6.3.1 Directory.

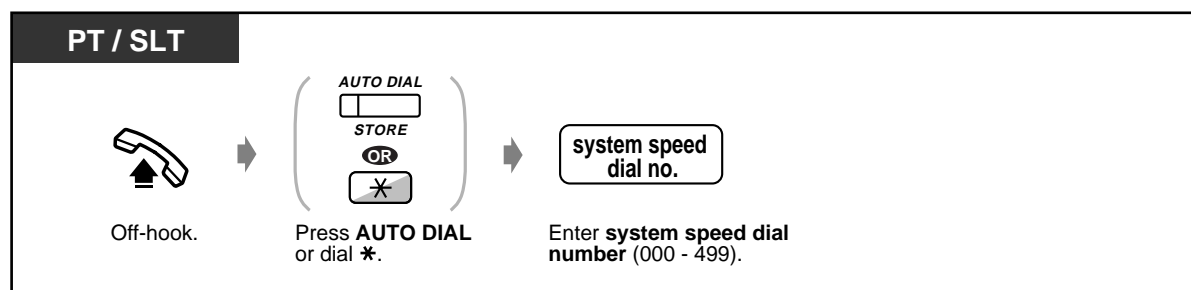

- More than one speed dial number can be used for long telephone numbers, if the number is divided when stored.

<Dialling Example>

If the number is divided and stored in system speed dial numbers 001 and 002:

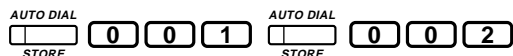

Customising Your System

- 4.2.3 System Speed Dialling Number Set (001)
- 4.2.4 System Speed Dialling Name Set (002)

◆◆ **To a pre-set party by going off-hook (Pickup Dialling)**

You can make an outside call simply by going off-hook if you pre-assigned.

◆ **To store a phone number**

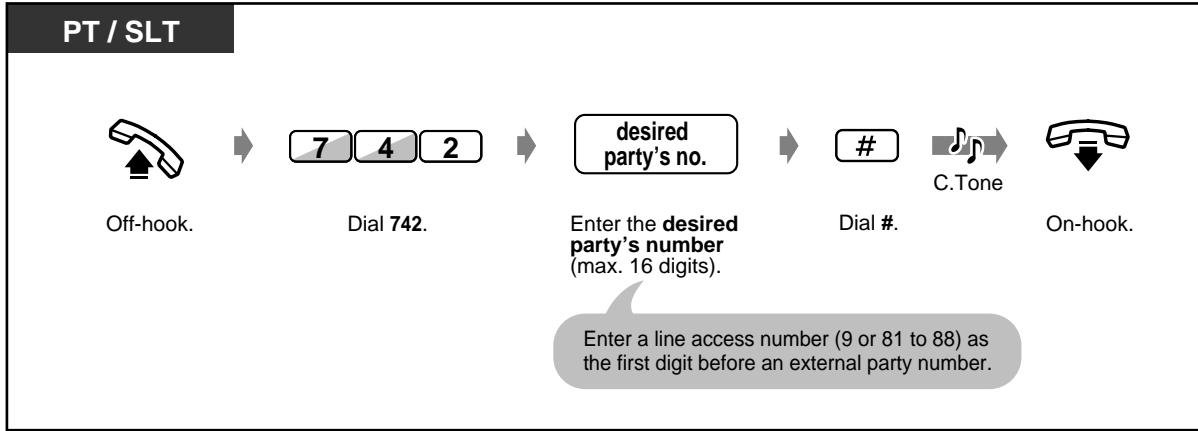

◆ **To set / cancel**

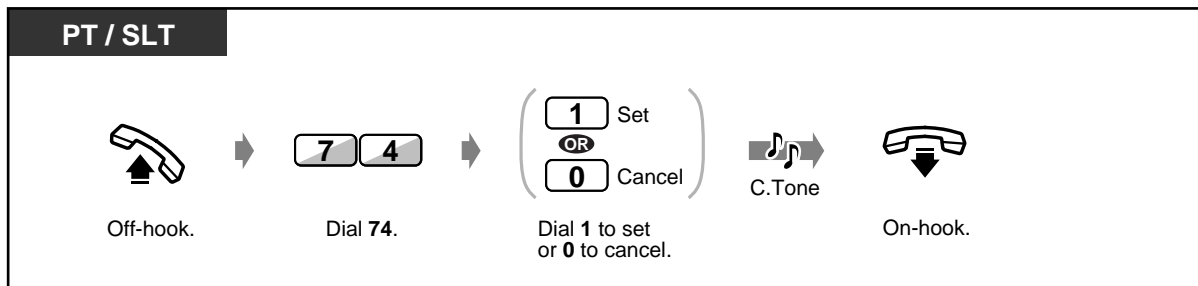

◆ **To dial**



- **To call another party**, dial the desired party's phone number before the pre-set line is connected. (Default: 1 second)
- "*" can also be stored as a digit.
- This feature is not available for an ISDN telephone user.

◆◆ Using a pre-assigned number (Quick Dialling)

You can make a call simply by pressing the number pre-assigned as quick dialling.

Up to 80 parties can be stored in the system. Consult your manager or dealer for details and refer to the directory on Page 230.

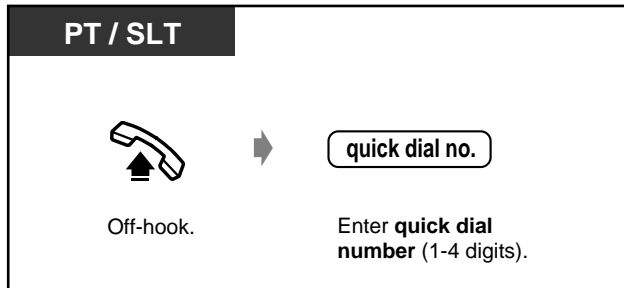

◆◆ To a Phantom extension

You can call extensions associated with a Phantom extension. The call arrives at all extensions who have the corresponding Phantom extension button.

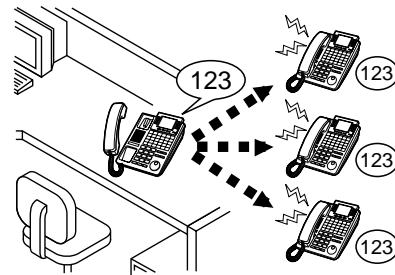

◆ To call or transfer to a phantom extension

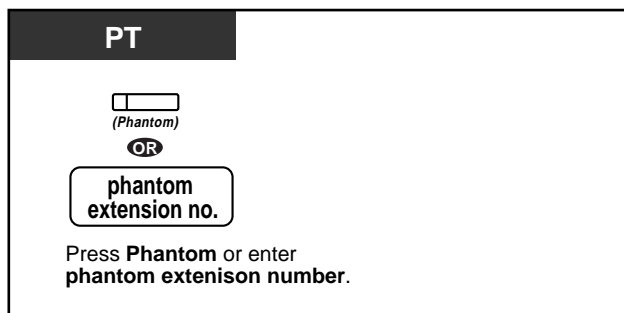

◆ To answer

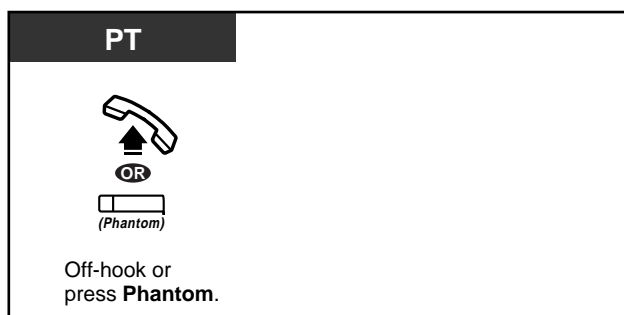



- The Phantom extension button light shows the current status as follows:
Off: Idle
Red on: You are calling a phantom extension.
Flashing green: Incoming call
- To set ringing or not, refer to 4.1.1 Customising Your Phone (Station Programming).



Customising Your Phone

- 4.1.3 Customising the Buttons
Create or re-arrange a Phantom extension button.

2.2.3 Redial

This is convenient when calling the same external party again.

- Redialling the last number you dialled
- Saving the number and redialling



- Up to twenty-four digits can be stored and redialled. The line access number is not counted as a digit.



- **To redial automatically**, go off-hook with the SP-PHONE button and then the REDIAL button, or press the REDIAL button directly. It will keep trying the busy number until the called party answers within a specified time (Automatic Redial). You can perform other tasks during dialling. To cancel, press the FLASH button or perform another operation.



Customising Your Phone

- 4.1.2 Initial Settings—**Full One-Touch Dialling Assignment**
Allow or cancel the one-touch operation while on-hook. (Default: Allow)

◆◆ Redialling the last number you dialled (*Last Number Redial*)

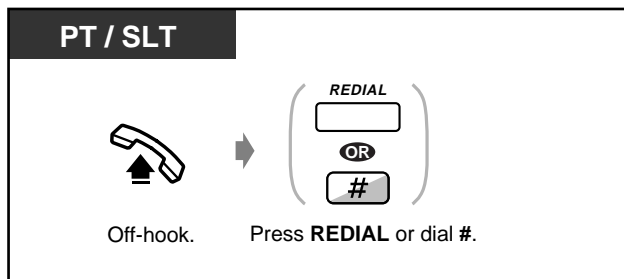

◆◆ Saving the number and redialling (Saved Number Redial)



The saved number is programmed until another number is stored.



◆ To save

PT

During a conversation or while hearing a busy tone

<p>AUTO DIAL</p>  <p>STORE</p> <p>Press STORE.</p>	➔	<p>SAVE</p>  <p>Press SAVE.</p>
--	---	--

◆ To dial

PT

 <p>Off-hook.</p>	➔	<p>SAVE</p>  <p>Press SAVE.</p>
--	---	--



Customising Your Phone

- 4.1.3 Customising the Buttons
Create or re-arrange a SAVE button.

2.2.4 When the Dialed Line is Busy or There is No Answer

- Reserving a busy line
- Sending a call waiting tone
- Leaving a message waiting indication
- Joining an existing call

◆◆ Reserving a busy line (Automatic Callback Busy)

You can set the telephone to receive call-back ringing when a dialed line becomes idle. When you answer the call-back ringing:

For an outside call: The line is seized.

For an intercom call: The called extension starts ringing automatically.

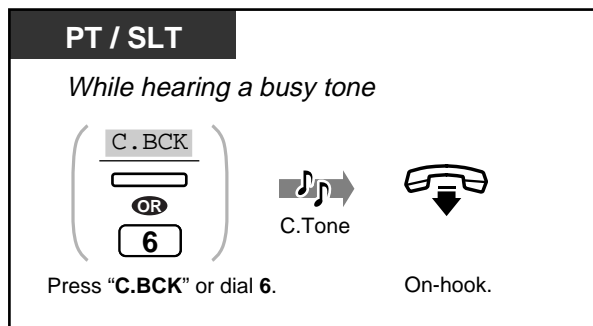

◆ To answer a call-back ringing and call

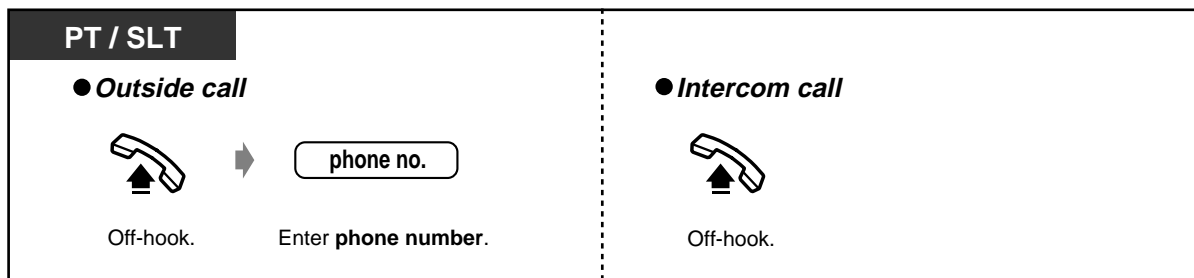

- If you do not answer after four call-back rings, this feature will be cancelled.
- If you go off-hook before call-back ringing starts, this feature is cancelled.
- This feature is not available for an ISDN telephone user.

◆◆ **Sending a call waiting tone (Busy Station Signalling [BSS])**

The party will know your call is waiting.

PT / SLT

While hearing a busy tone

BSS

OR
1

Press "BSS" or dial 1.



- If "BSS" is not displayed or you hear a reorder tone, this feature is not set at the other party's phone. This feature is only available if the called extension has set the "Call Waiting" feature.
- Depending on the other party's telephone, the "Off-Hook Call Announcement (OHCA)" and the "Whisper OHCA" functions can be applied. You can talk to the other party through the speaker and the microphone (OHCA) or you only send a call announcement through the handset (Whisper OHCA), while they are having another conversation using the handset. Only KX-T7400 series telephone users can send Whisper OHCA.
- This feature is not available for an ISDN telephone user.

◆◆ **Leaving a message waiting indication (Message Waiting)**

The called extension receives a message waiting indication (MESSAGE button light turns on and / or indication tone* is emitted when going off-hook) to call you back.

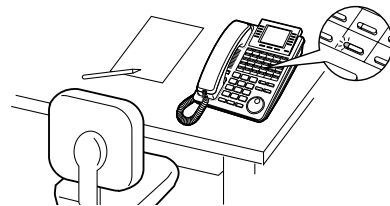

◆ **To leave a message waiting indication**

PT / SLT

When the called extension is busy or does not answer

MESSAGE

OR
4

Press **MESSAGE** or dial 4.

C.Tone

On-hook.

◆ To leave / cancel a message waiting indication

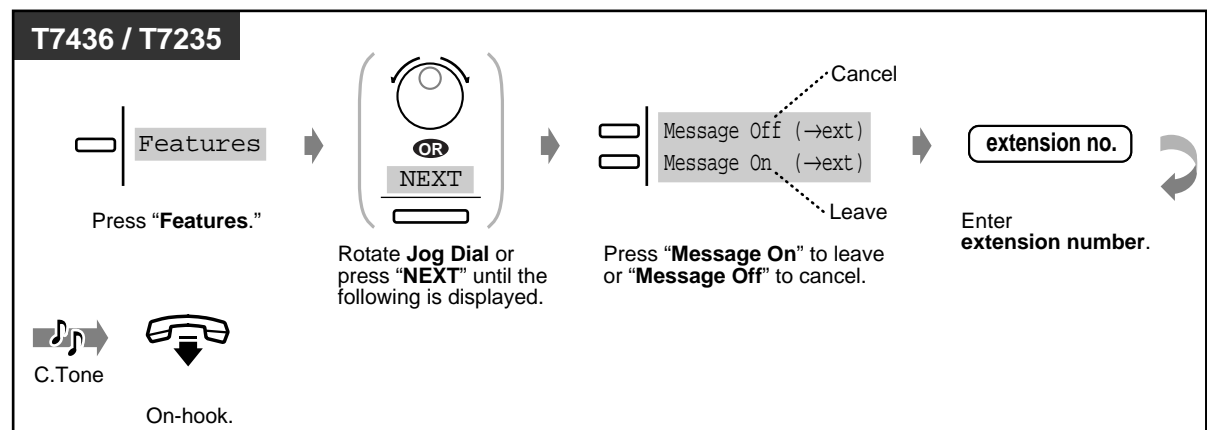
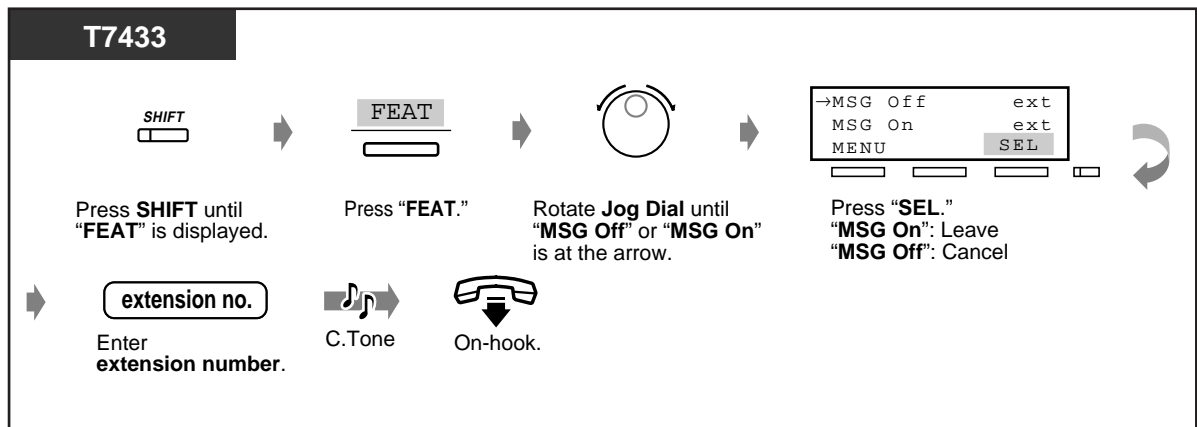
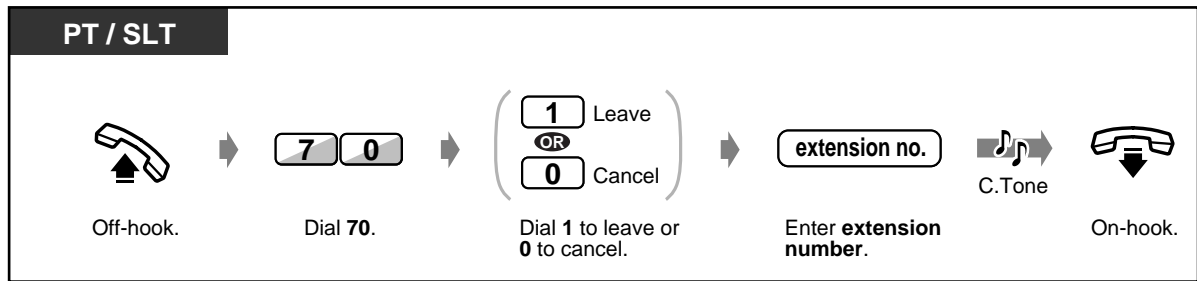

◆ **To check and select the party**

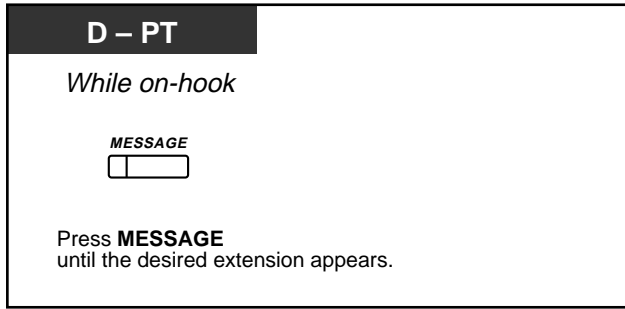

- The extension number and name are shown in the received order.
- This feature is also available for the users of a single line telephone with a message waiting lamp.
- Single line telephone users without a message waiting lamp may hear a special ring tone as notification while on-hook, if required.
- This feature is not available for an ISDN telephone user.
- * Indication tone



◆ **To call back**

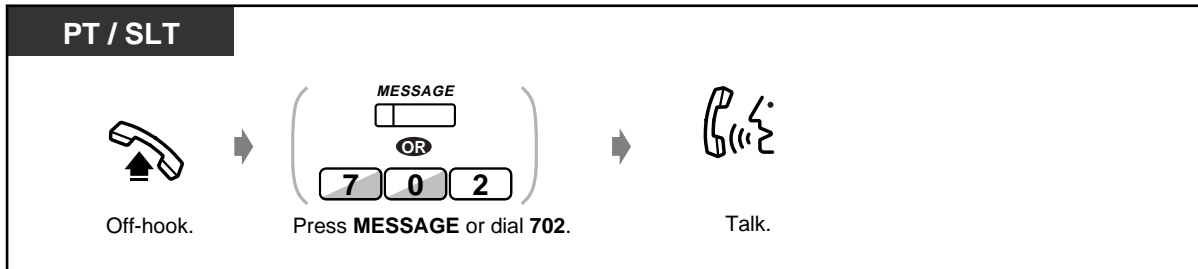

◆ **To clear all message waiting indications**

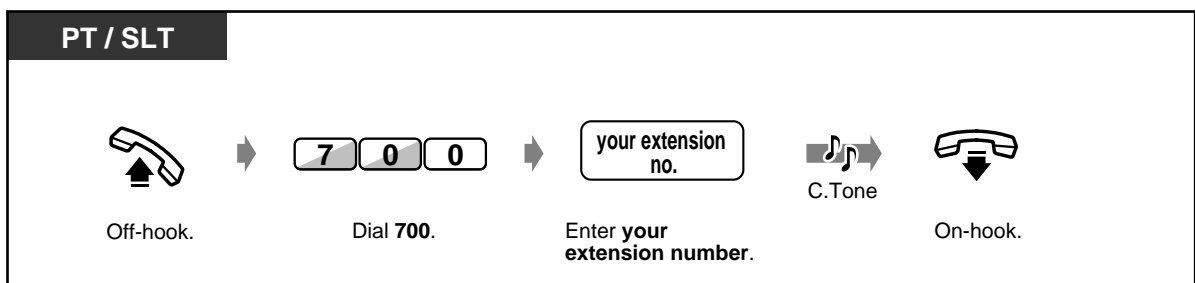

Customising Your Phone

- 4.1.3 Customising the Buttons
Create or re-arrange a MESSAGE button.

◆◆ **Joining an existing call (Executive Busy Override)**

You can call the party who is talking with another on the telephone or add a third party to your existing conversation.

◆ **To join**

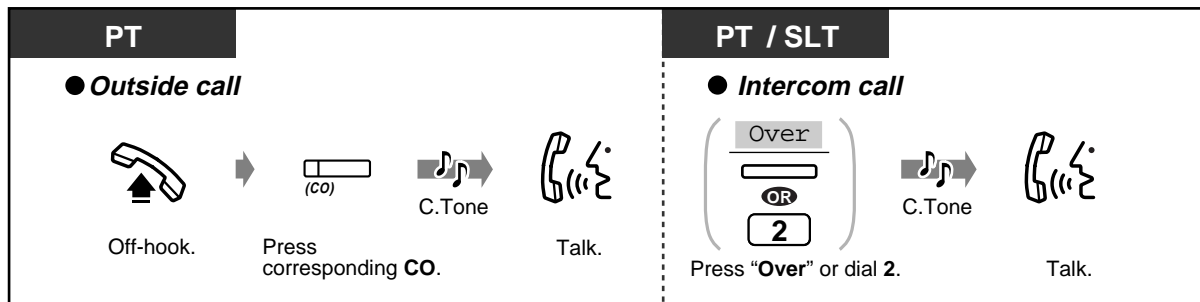

◆ **To disconnect one party and talk with another when one of these parties is an outside call**

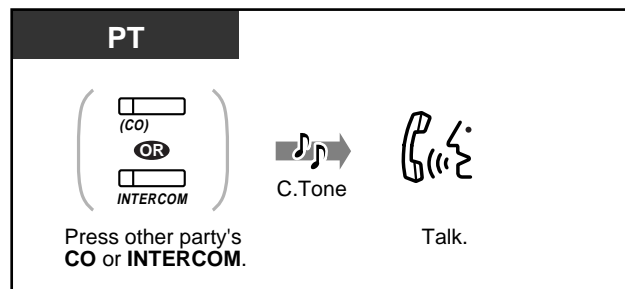

- You can also deny others the possibility of joining your conversation (Default: Allow). Refer to 2.7 Setting the Telephone According to Your Needs.

2.2.5 Calling without Restrictions

- Using an account code
- Changing the dialling mode
- To an extension refusing the call

◆◆ Using an account code (Account Code Entry)

An Account Code gives information about outside calls for accounting and billing purposes. You may not be able to make an outside call without an account code entry. A mode is assigned to each user. Ask your manager for your mode.

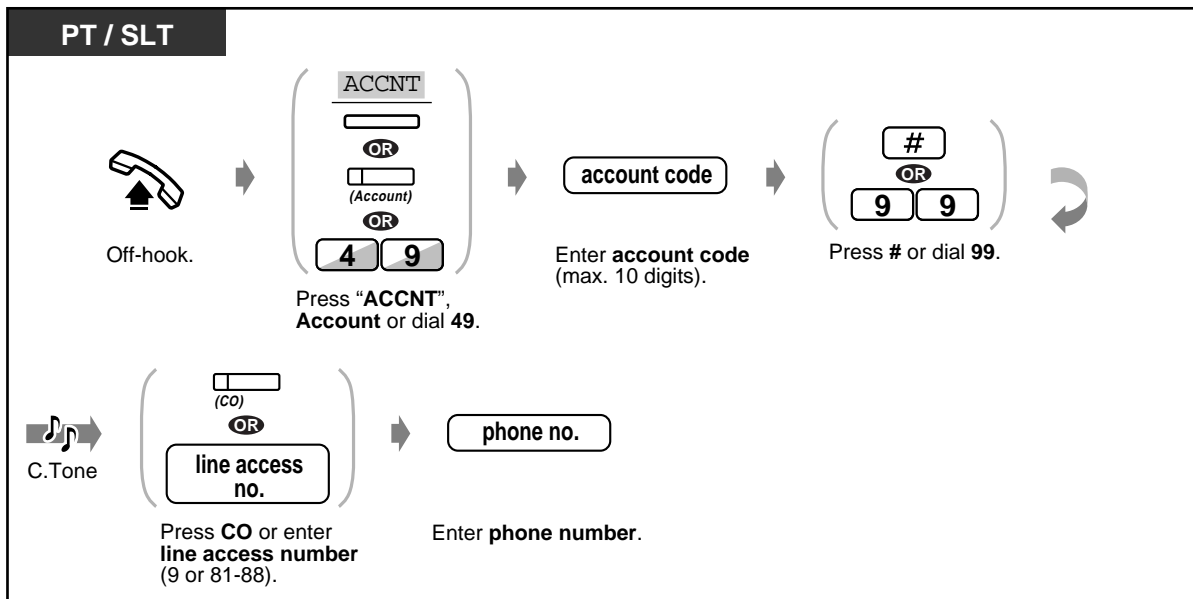

- **A Panasonic proprietary telephone user** can enter an account code during a conversation and when hearing a reorder tone after the other party hangs up.
- **If you enter the wrong code**, press the "*" key while entering the account code and then re-enter the code.
- **To cancel the entry**, press the Account button or the hookswitch while entering the code.
- **For your convenience**, you can store the code with the phone number in memory (e.g. Speed dialling).
- **If you hear a reorder tone**, the entered account code is wrong. Enter the correct code.



- You may give a specified account code to extension users and check their telephone usage. You can specify an account code to each client and check the call duration.



Customising Your Phone

- 4.1.3 Customising the Buttons
Create or re-arrange an Account button.

◆◆ To an extension refusing the call (DND Override)

PT / SLT

While hearing the DND tone

Over

OR

1

Press "Over" or dial 1.



- This feature is not available for an ISDN telephone user.

◆◆ Changing the dialling mode (Pulse to Tone Conversion)

To access services such as computer telephone services, Voice Mail, etc., that require a tone, you can temporarily change the dialling mode from Pulse to Tone.

PT / SLT

After the line is connected

→

Dial *#. Enter desired number.

2.2.6 Accessing the ISDN Network Service (ISDN Network Service Access)

You can access a service which is provided from the ISDN network.



◆ To access

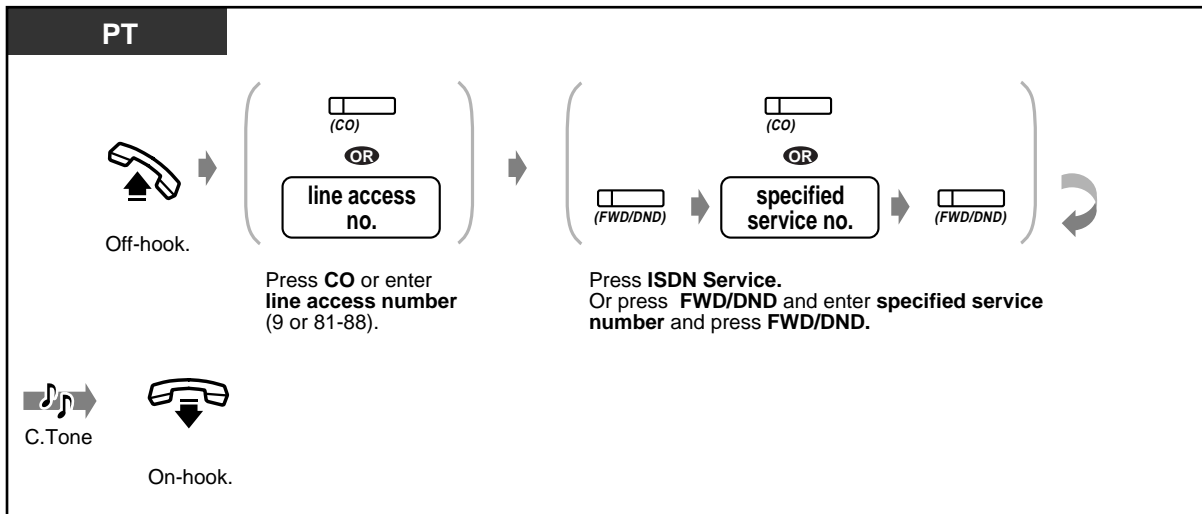

2.2.7 Alternating the Calling Method (Alternate Calling — Ring / Voice)

The calling method, either ring or voice, is set by the called extension when an intercom call is received. However, you can change the method temporarily.

Ring-Calling (Default): You can call the other party with a ring tone.

Voice-Calling: You can talk to the other party immediately after a confirmation tone.

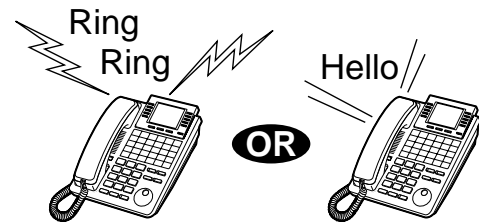

◆ For voice-calling

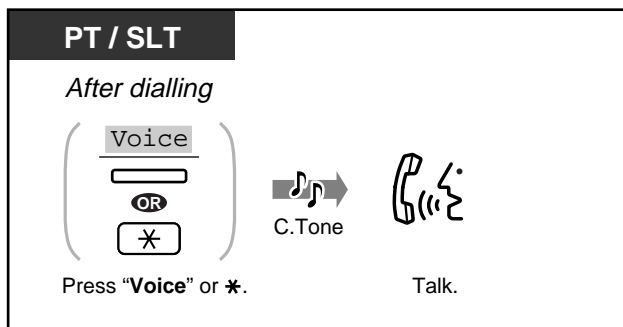

◆ For ring-calling

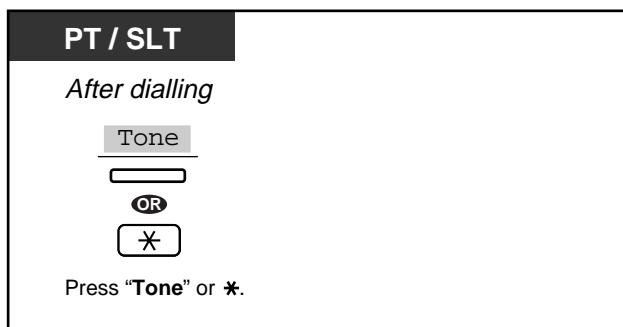

- If the called party uses a single line telephone, only Ring-Calling is available.
- You can switch the desired calling method only once during a call.



Customising Your Phone

- 4.1.2 Initial Settings—Intercom Alert Assignment
Which way do you prefer to receive an intercom call?

2.2.8 To Access Another Party Directly from Outside (Direct Inward System Access [DISA])

External callers can call extensions in the system. An outgoing message greets the caller and gives information about how to access an extension. You do not need the operator's assistance. You may not be able to access the features without a DISA user code depending on the security mode. Ask your manager for the mode assigned to your system.

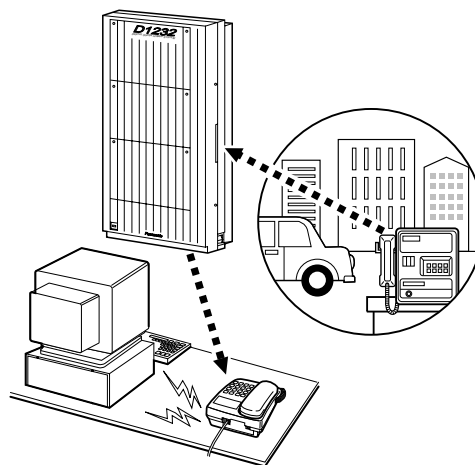

◆ To call an extension

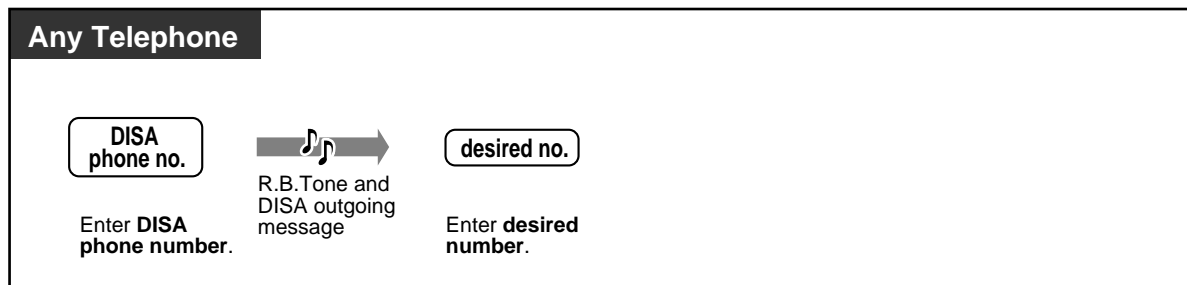

◆ To call an external party

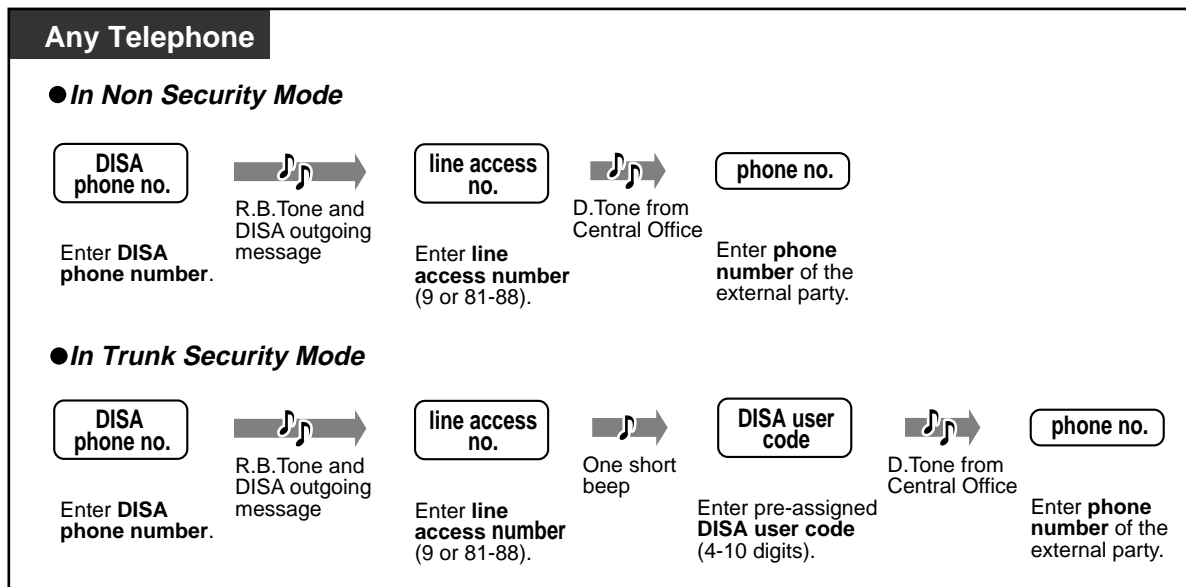

◆ To re-try

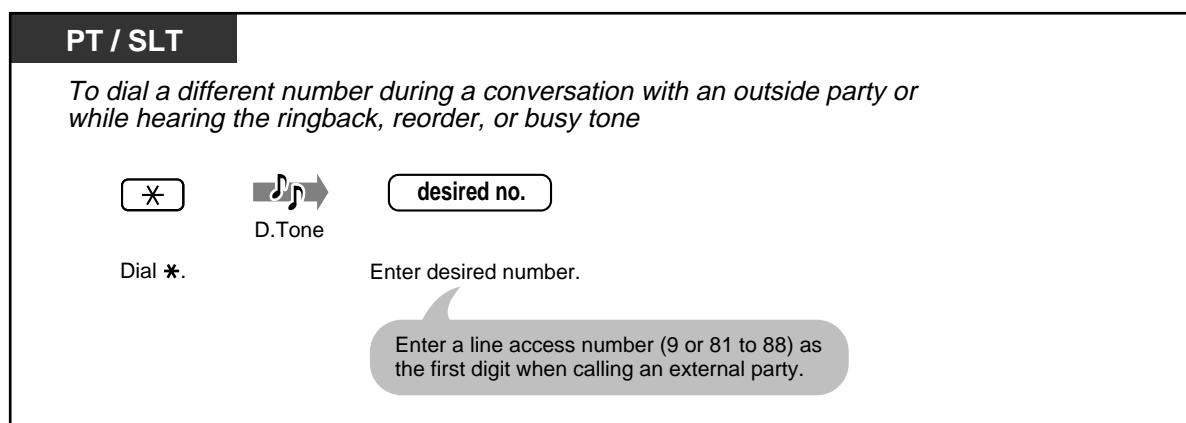

2.3 Receiving Calls

2.3.1 Answering Calls

PT / SLT



Off-hook. Talk.

Select one of the following methods:

- Lift the handset to receive the preferred line.
(Default: Ringing line is selected.)
- Press the SP-PHONE or MONITOR* button.
- Press the flashing red CO or green INTERCOM button directly.



* **When going off-hook using the MONITOR button**, you have to lift the handset to talk to the other party.



- **Hands-free operation**

You can have a conversation in the hands-free mode with the SP-PHONE button. You can perform other tasks at the same time.

Helpful hints for the hands-free operation

Use your telephone in a quiet room for best performance.

If the other party has difficulty hearing you, decrease the volume.

If you and the other party talk at the same time, parts of your conversation will be lost. To avoid this, talk alternately.

- **If the CLIP feature is available**, you may confirm the caller's phone number and name before answering an outside call. It is available for PT users only.

Pressing the SHIFT button or "*" displays the caller's number and name, the outside line number and name or the called party's number and name as follows:

<Example>

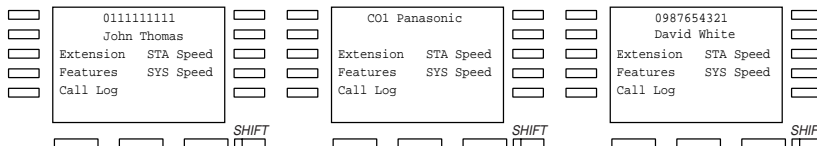

The caller's information from your telephone company will only be sent to the pre-assigned extension.



Customising Your Phone

- 4.1.2 Initial Settings—
Preferred Line Assignment - Incoming
Select the seized line when going off hook.
Intercom Alert Assignment
Select the Calling method, either ring or the other party's voice.
- 4.1.3 Customising the Buttons
Re-arrange the CO button and change the ringing tone for each CO button.

2.3.2 Answering Hands-free (Hands-free Answerback)

You can answer an intercom call without going off-hook as soon as the line is connected. You will hear the caller talking without the phone ringing.



◆ To set / cancel

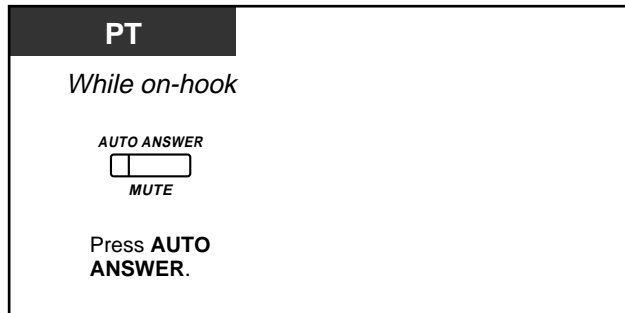

- The AUTO ANSWER button light shows the current status as follows:
On: Set.
Off: Not set.

2.3.3 Answering a Call Ringing at Another Telephone (Call Pickup)

You can answer an incoming call that is ringing at another extension from your phone without leaving your desk.

The following types are available:

Outside (CO) Call Pickup: Picks up an outside call.

Group Call Pickup: Picks up a call within your extension group.

Directed Call Pickup: Picks up a specified extension's call.

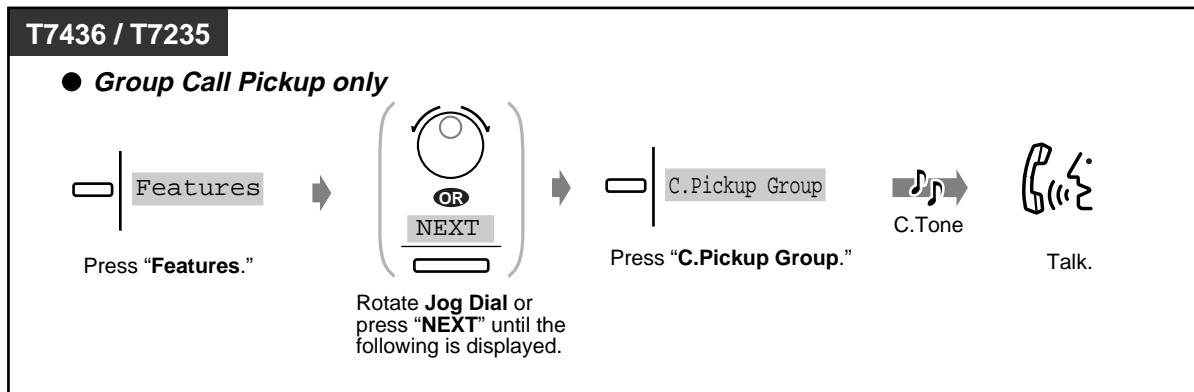
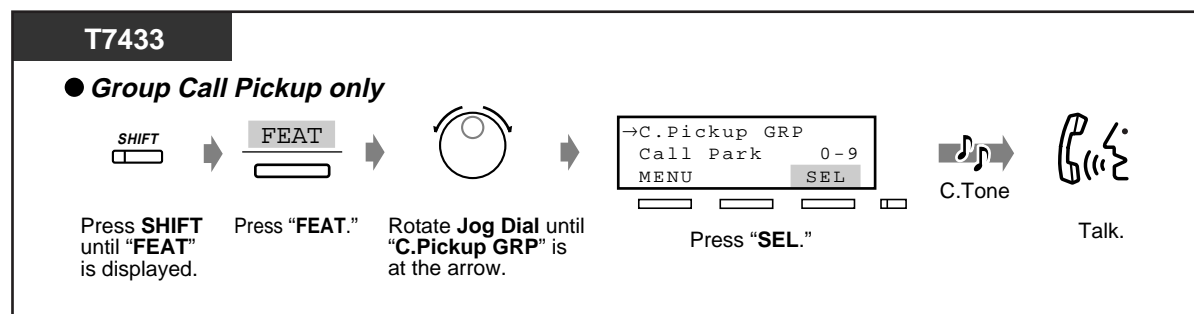
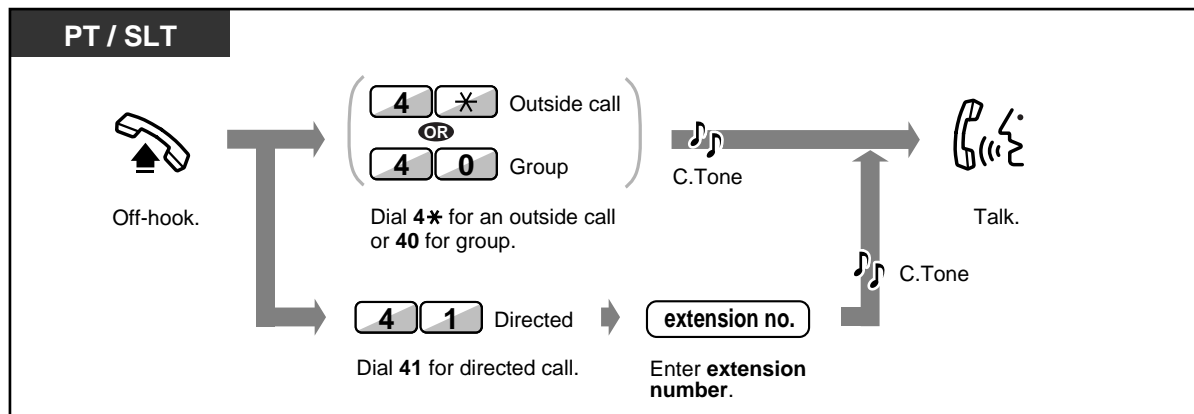



- **If you receive a call waiting tone**, you can ask a third party to pick up your second call with Directed Call Pickup.
- "Group Call Pickup" is not available for an ISDN telephone user.



- You can also deny other people the possibility of picking up your calls. Refer to 2.7 Setting the Telephone According to Your Needs.

2.3.4 Answering a Call via an External Speaker (Trunk Answer From Any Station [TAFAS])

You can answer an incoming outside call paged through an external speaker from any extension.

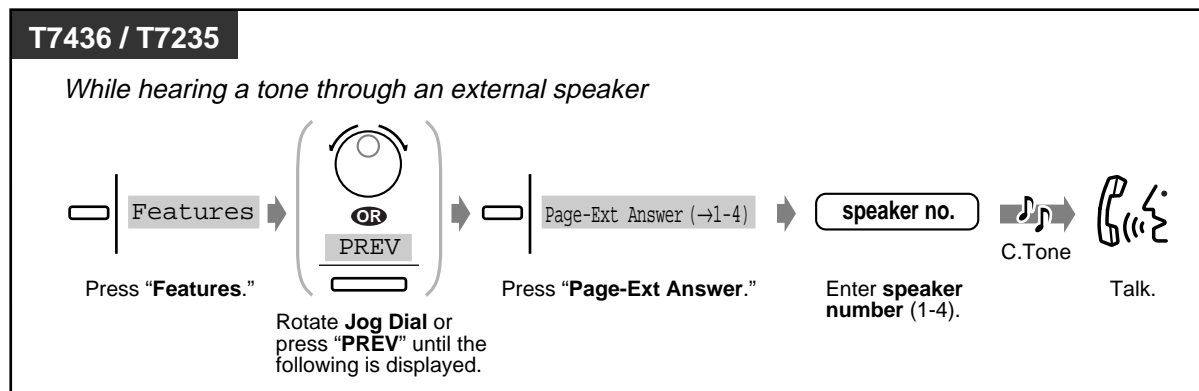
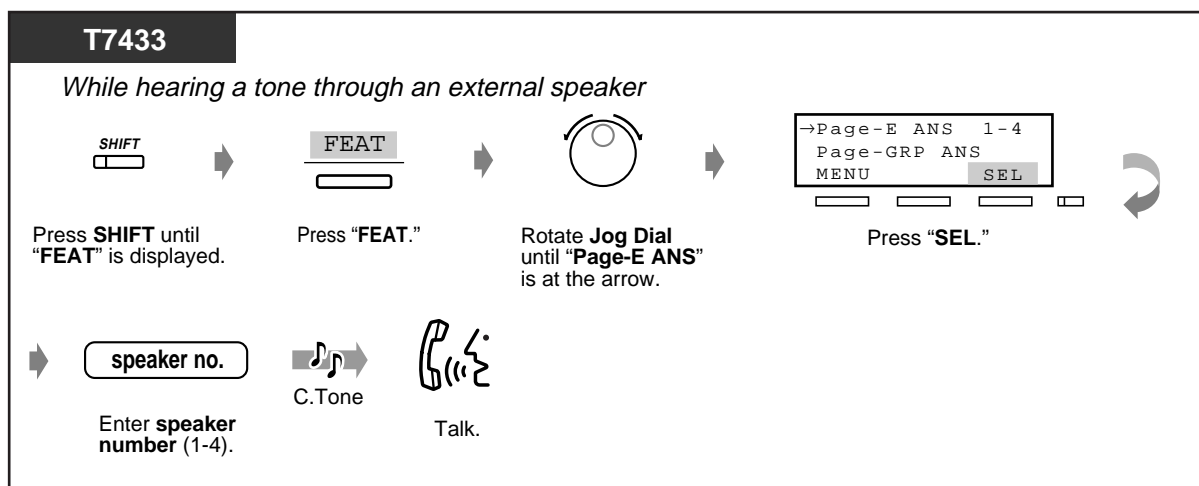
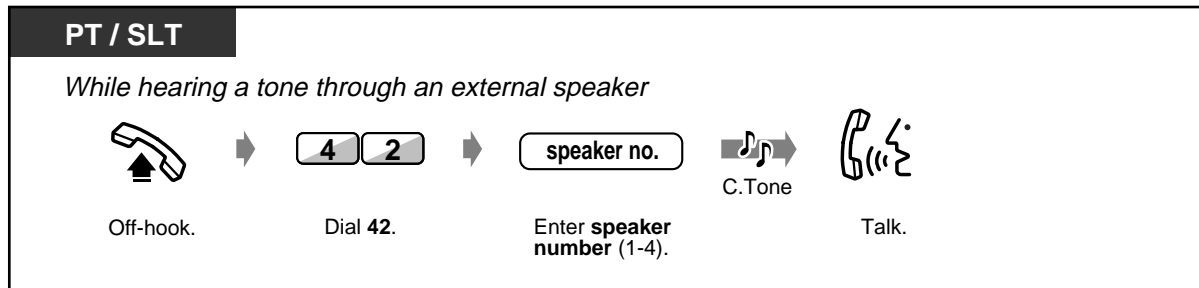

- You can also receive a paged announcement via a speaker with this operation.

2.4 During a Conversation

2.4.1 Holding a Call

- Holding
- Denying other people the possibility of retrieving your held calls
- Holding in a system parking zone



- If a call is not retrieved within a specified time, you will hear an alarm as a reminder.
- If a call is not retrieved within thirty minutes, it is automatically disconnected.

◆◆ Holding (regular)

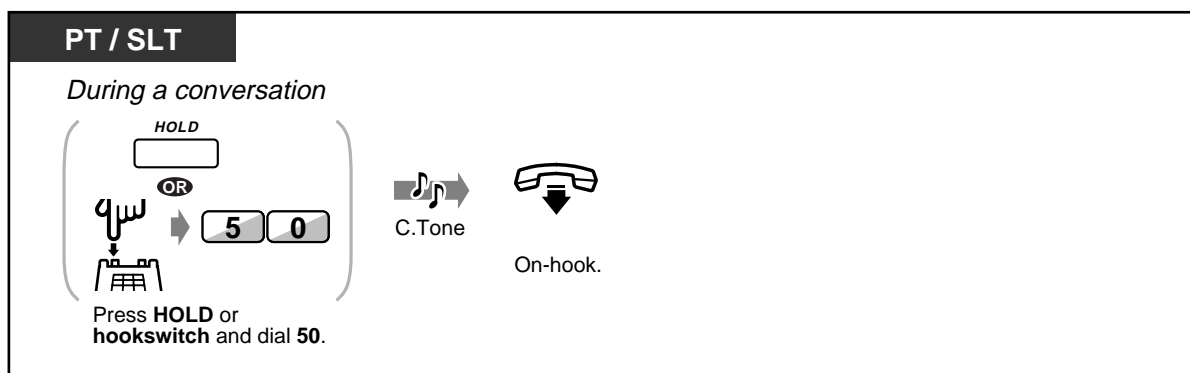

◆ **To retrieve a call**

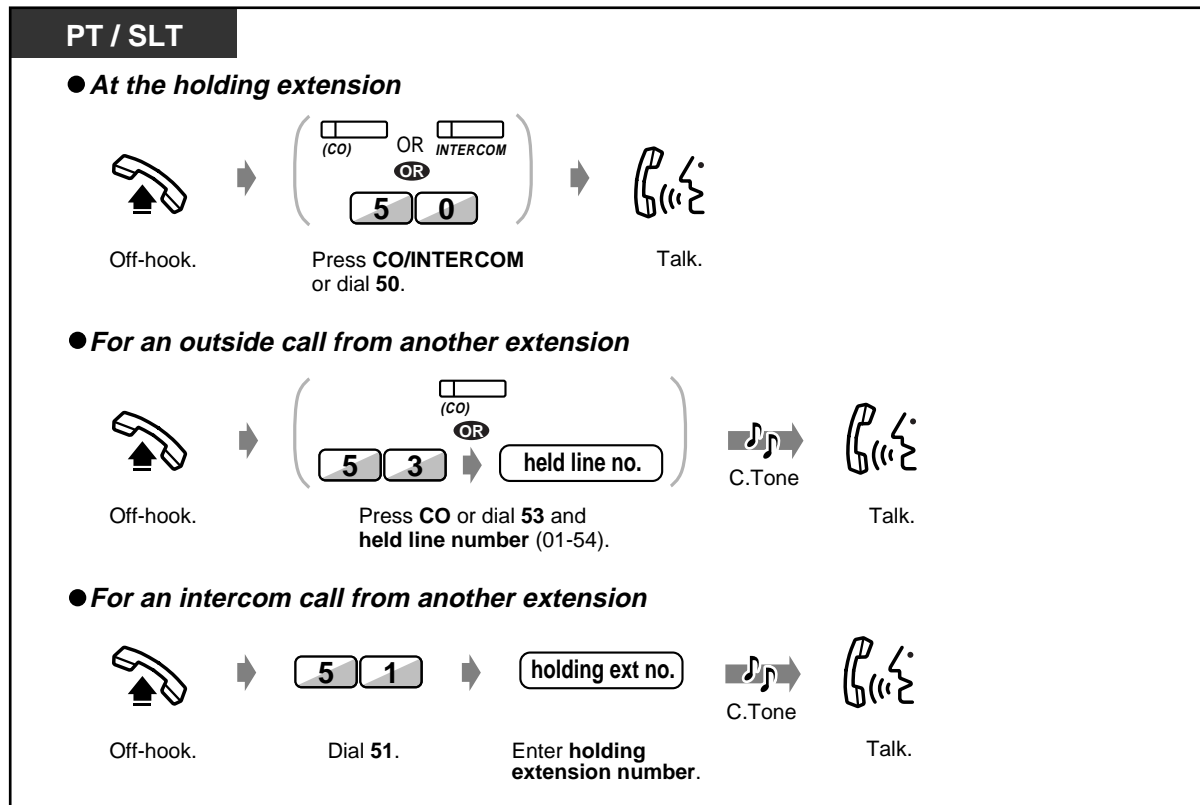

- The CO or INTERCOM button light shows the current status as follows:

Flashing green: Your held call

Flashing red: Another extension's held call

- A single line telephone user can hold either an intercom call or an outside call at one time.
- A proprietary telephone user can hold an intercom call and multiple outside calls.
- **To hold multiple intercom calls**, use the "Call Park" feature.
- This feature is not available for an ISDN telephone user.

◆◆ Denying other people the possibility of retrieving your held calls (Exclusive Call Hold)

Only the held extension can retrieve the call.

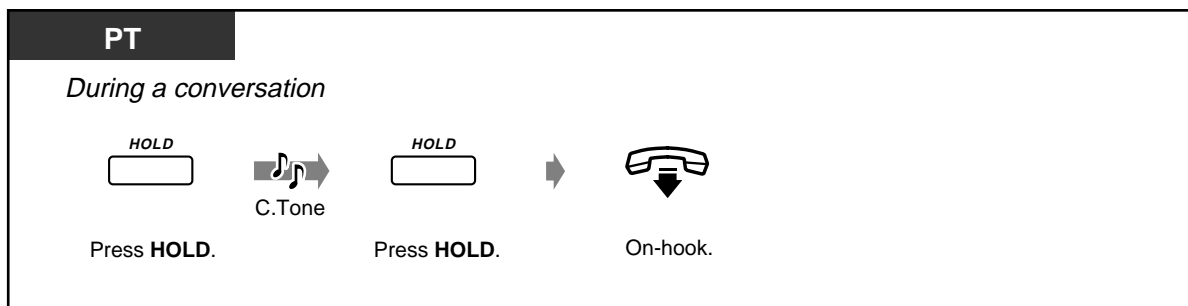

◆ To retrieve a call

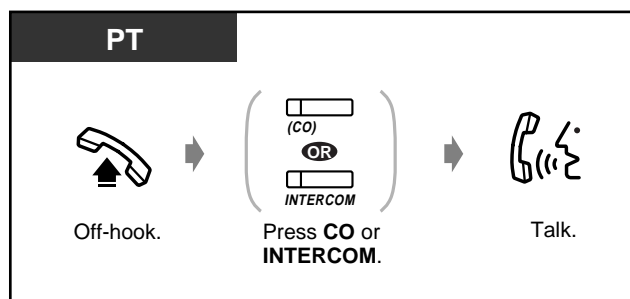

- A proprietary telephone user can hold an intercom call and multiple outside calls.

◆◆ Holding in a system parking zone (Call Park)

You can park a call and perform other operations. The parked call can be retrieved by any extension. Up to ten calls can be parked.

◆ To set

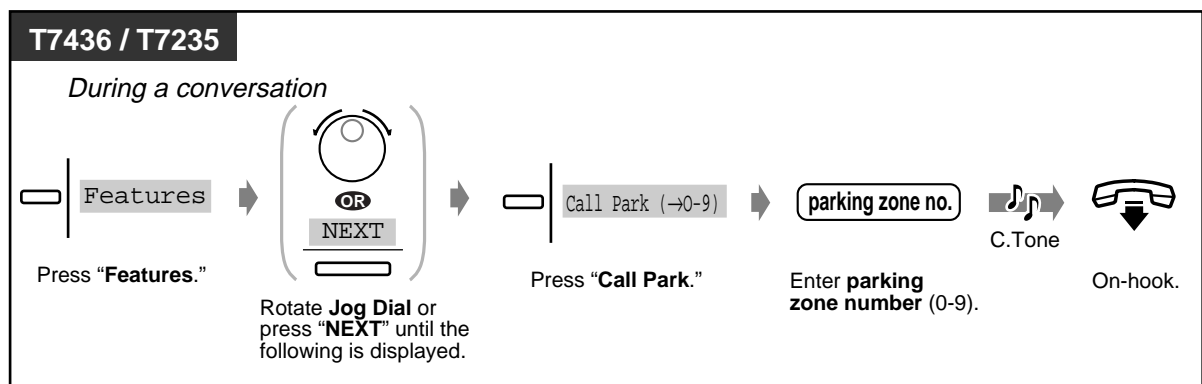
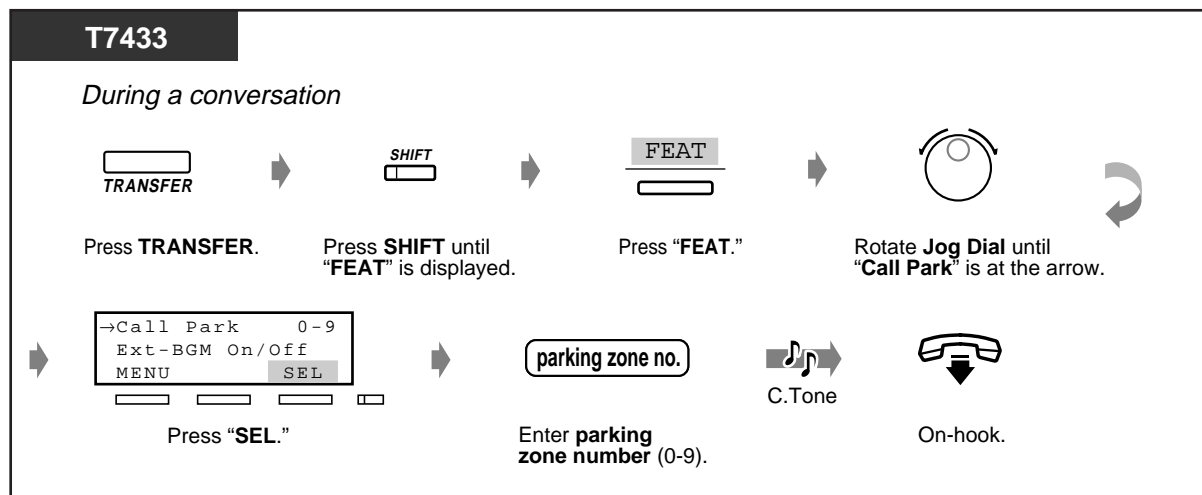
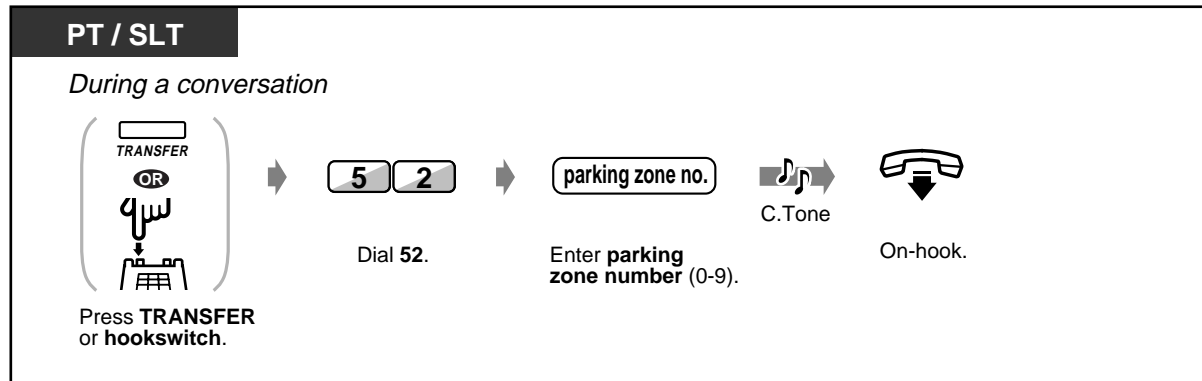

◆ To retrieve

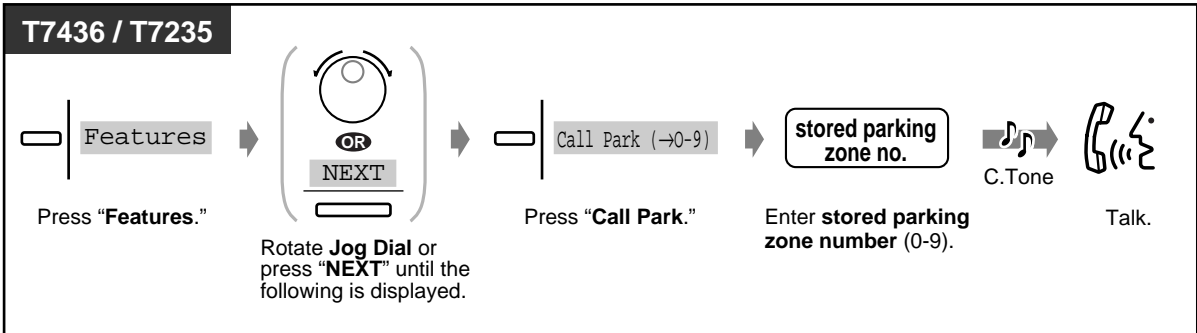
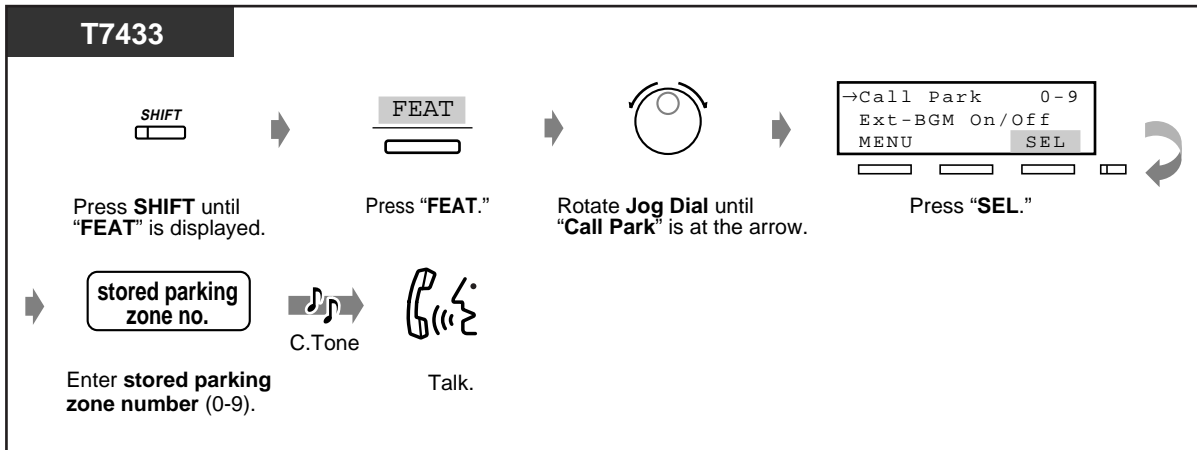
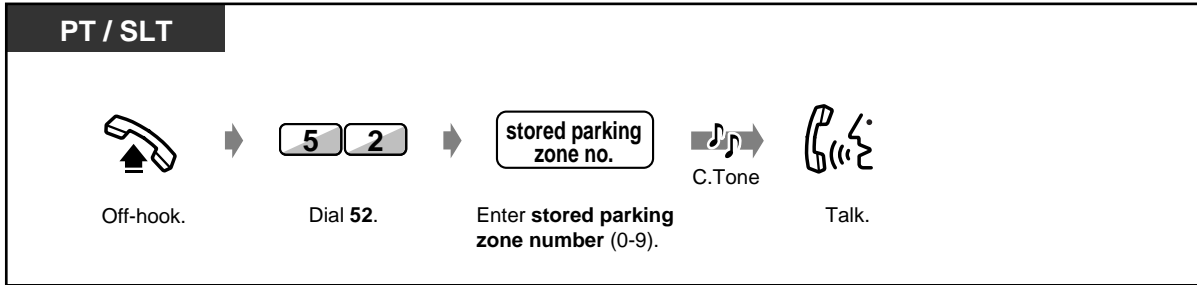

- Holding in a system parking zone is not available for an ISDN telephone user.



- **If you hear a busy tone when parking a call and entering the zone number**, the zone is in use. Enter another number.
- **If you hear a reorder tone when retrieving a parked call**, there is no held call. Confirm the stored parking zone number.

2.4.2 Talking to Two Parties Alternately (Call Splitting)

When talking to one party while the other party is on hold, you can swap the calls back and forth (alternately).

- ◆ **To alternate the call between the parties while having a call on hold temporarily**

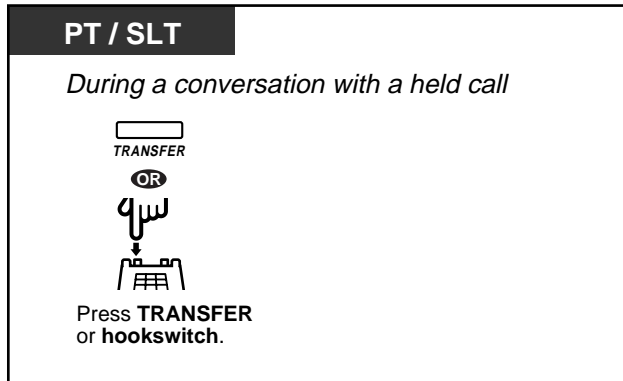

- ◆ **To alternate the call between the parties while having a call on exclusive hold**

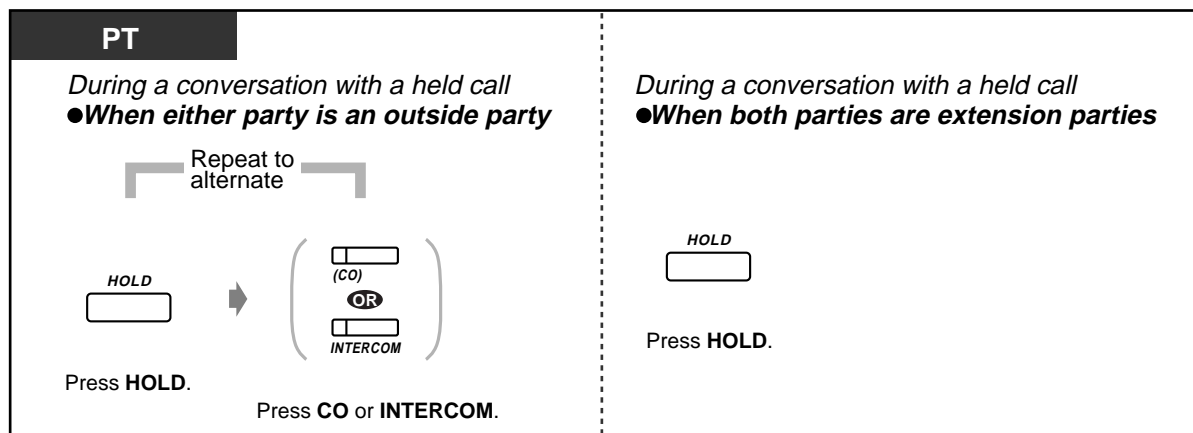

2.4.3 Transferring a Call

— Transferring to an extension

— Transferring to an external party

◆◆ Transferring to an extension

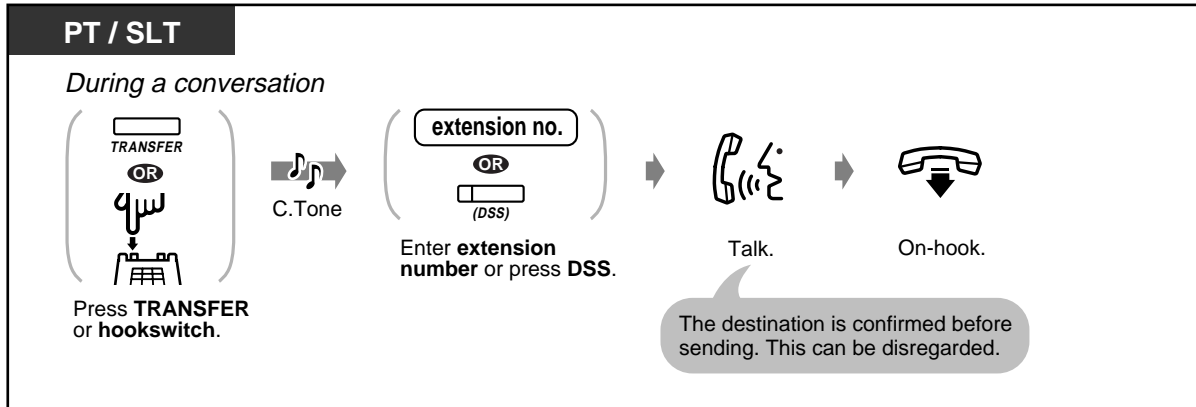

◆◆ Transferring to an external party

Some extensions may be restricted from performing this function.

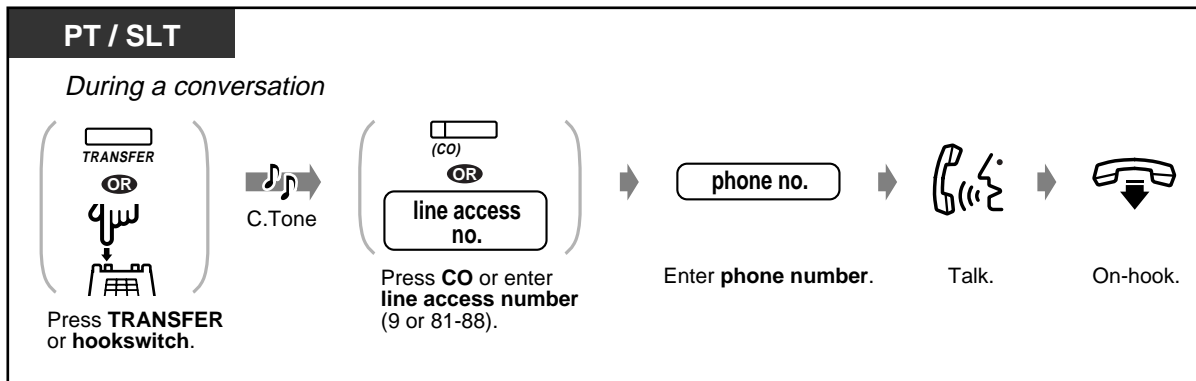

- **If you misdial**, press the FLASH (PT only) button, and re-enter the number.
- **If a call between two external parties is established**, both parties will hear an alert tone fifteen seconds before the time limit (Default: 10 min.) runs out. The original extension will hear an alarm fifty seconds before the time runs out.
- **To return to the held call before the destination answers**, press the TRANSFER button, corresponding CO, INTERCOM button, or the hookswitch.
- **To return to the conversation after completing the transfer to an external party**, press the corresponding CO button.
- **If you hear an alert tone**, the destination extension did not answer the call. Answer the call.
- This feature is not available for an ISDN telephone user.



- **If you transfer a call with the DSS button**, you do not have to press the Transfer button (One-Touch Transfer).



Customising Your Phone

- 4.1.3 Customising the Buttons
Create or re-arrange a DSS button.

2.4.4 Answering a Call Waiting

- Answering a call waiting in the system
- Answering a call waiting from the central office

◆◆ Answering a call waiting in the system

During a conversation, a call waiting tone or voice announcement through the speaker or the handset occurs when an outside call is received or another extension is letting you know another call is waiting. To activate this feature, set to "On." (Default: No tone) You can answer the second call by disconnecting the current call or placing it on hold.

◆ To talk to the new party

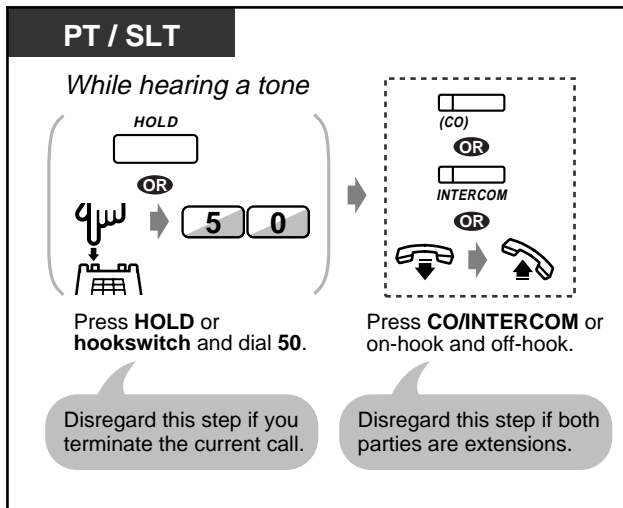

- **Depending on the other party's telephone**, the "Off-Hook Call Announcement (OHCA)" and the "Whisper OHCA" functions can be applied. You can talk to the other party through the speaker and the microphone (OHCA) or you only receive a call announcement through the handset (Whisper OHCA), while they are having another conversation using the handset.
- The calling extension's name or number is displayed for five seconds in ten second intervals before answering a call.
- This feature is not available for an ISDN telephone user.



Customising Your Phone

- 4.1.2 Initial Settings—**Call Waiting Tone Type Selection**

Determine the tone depending on the second party, either an outside call or an extension.

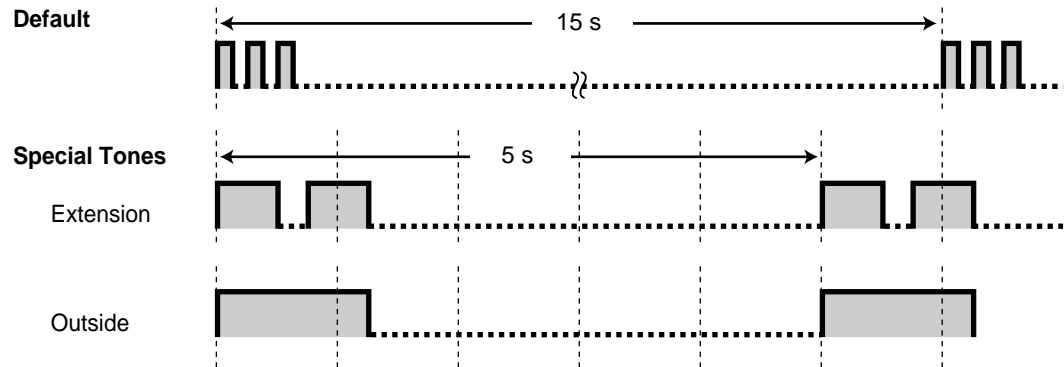

◆◆ Answering a call waiting from the central office

This is an optional telephone company service. For more information, consult your telephone company.

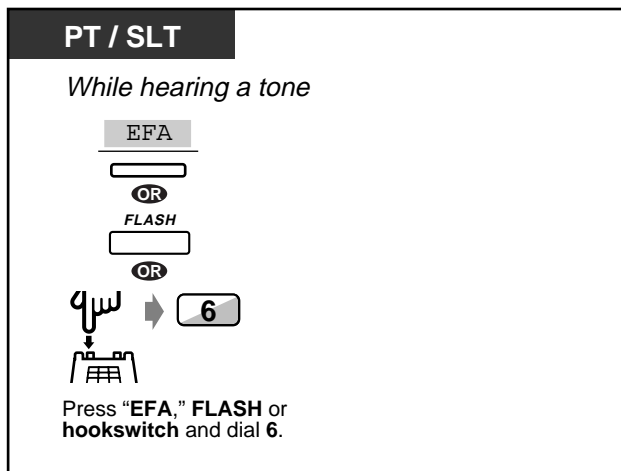

- **To return to the original party,** repeat the operation.
- In this case, if you programme "EFA" (External Feature Access) to the FLASH button by system programming, it is used to send a flash signal to the Central Office. For more details, consult your manager or dealer.

2.4.5 Three-party Conversation

- Adding a third party during a conversation
- Leaving a conference
- Letting a third party join your call

◆◆ Adding a third party during a conversation (Conference)

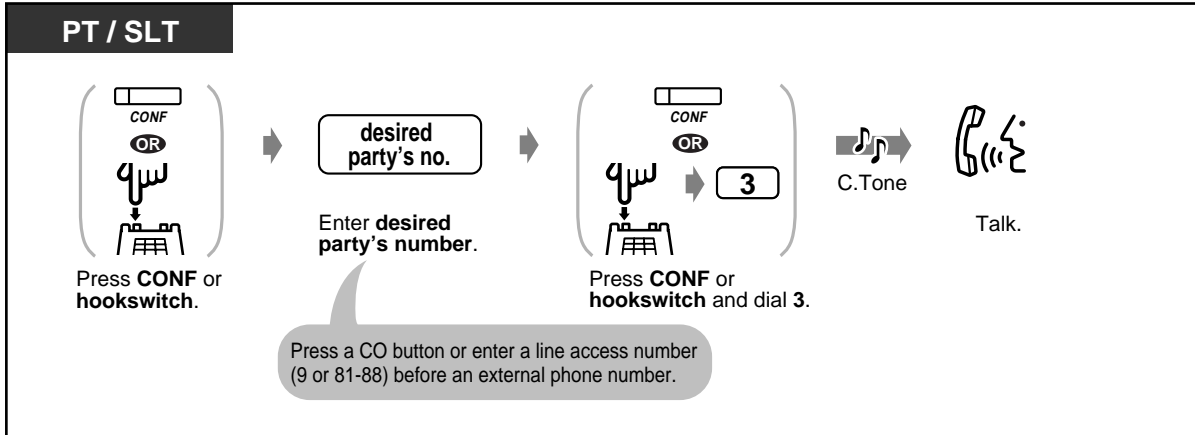

◆ To talk to one party by disconnecting the other when one of these parties is an outside call

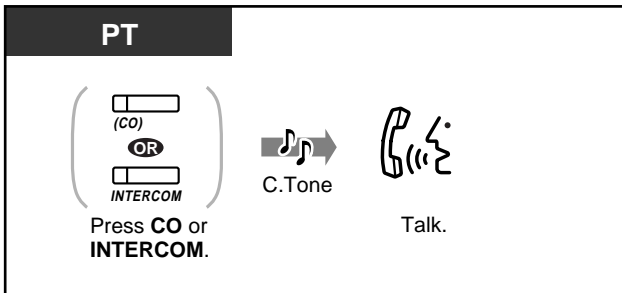

◆◆ Leaving a conference

The other two parties can continue their conversation.

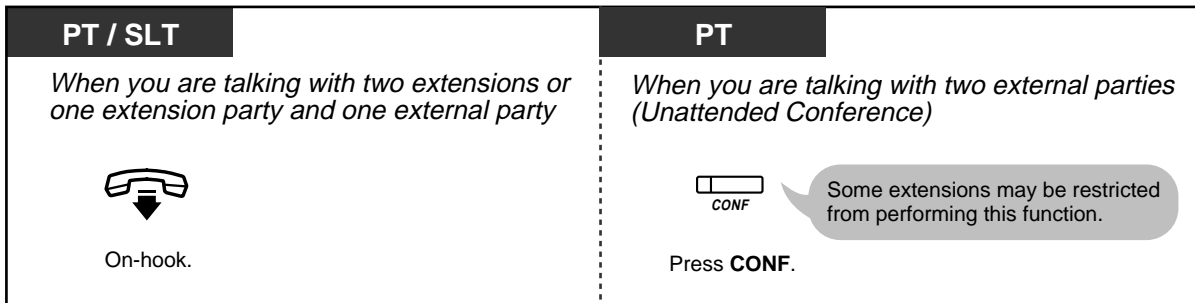

◆ To return

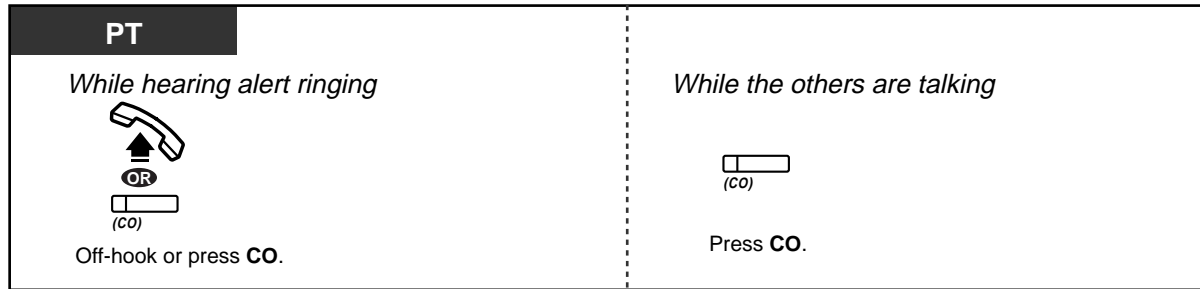

- **Time limit**

Both parties will hear an alert tone fifteen seconds before the time limit (Default: 10 min.) runs out. The original extension will hear an alert tone fifty seconds before the time runs out. The call is disconnected when the time runs out unless the original extension returns to the conference.

- This feature is not available for an ISDN telephone user.



- **Customising Your Phone**

- 4.1.3 Customising the Buttons
Create or re-arrange a Conference button.

◆◆ **Letting a third party join your call (Privacy Release)**

You can let a third party join your current outside call.

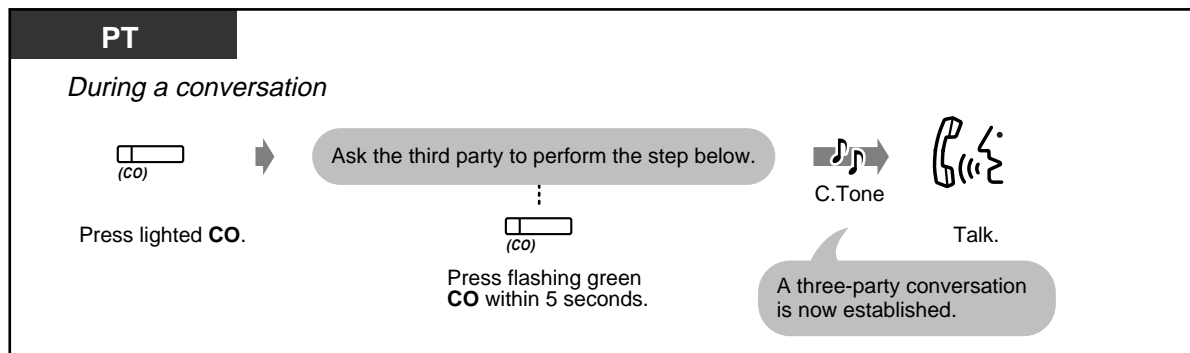

◆ **To leave**

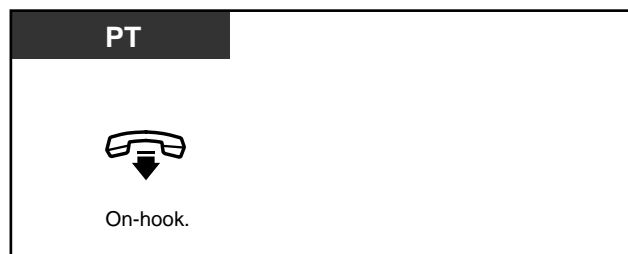

◆ **To talk to one party by disconnecting the other**

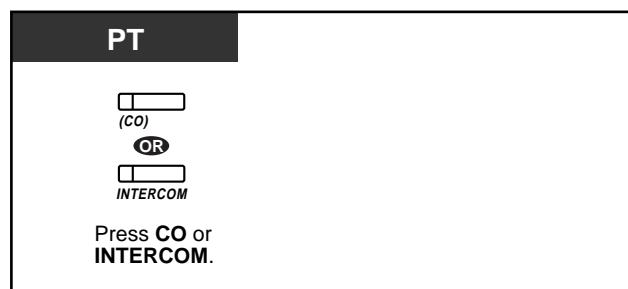

- This feature overrides "Data Line Security" and "Executive Busy Override Deny."

2.4.6 Mute

You can disable the microphone or the handset to consult privately with others in the room while listening to the other party on the phone through the speaker or the handset.

There are two types of mute as follows:

Handset Mute:

During a conversation using the handset. This function is available for the KX-T7400 series telephone users only.

Microphone Mute:

During a conversation using the microphone.



◆ To set / cancel

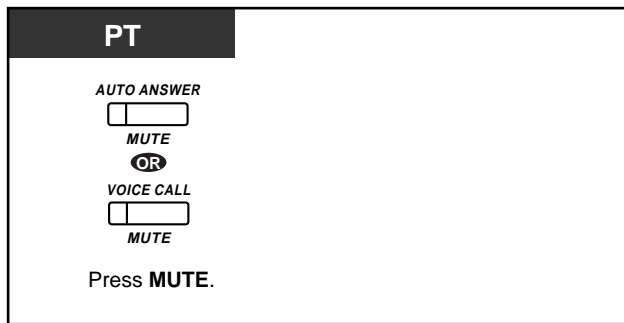

- The AUTO ANSWER/MUTE or VOICE CALL/MUTE button light shows the current status as follows:

Flashing red: Mute

Off: Normal

2.4.7 Letting Other People Listen to the Conversation (Off-Hook Monitor) [KX-T7433, KX-T7436 only]

You can let other people in the room listen to the conversation through the speaker while continuing the conversation using the handset.

◆ **To set / cancel**



- This feature is only available during a conversation using the handset.
- The SP-PHONE button light shows the current status as follows:
 - On:** The voice is heard through the speaker.
 - Off:** The voice is heard through the handset.

2.5 Before Leaving Your Desk

2.5.1 Forwarding Your Calls (Call Forwarding)

You can have your incoming calls forwarded to a specific destination. According to intercom or outside incoming calls, you can set the different destination each.

All Calls:

All calls are forwarded to another extension.

Busy:

All calls are forwarded to another internal destination when your extension is busy.

No Answer:

All calls are forwarded to another internal destination when you do not answer the call.

Busy/No Answer (BSY/NA):

All calls are forwarded to another internal destination when you do not answer or when your extension is busy.

To Outside Line (CO Line):

All calls are forwarded to an external party. Some extensions may be restricted.

Follow Me (From):

If you forget to set "All Calls" to be forwarded before you leave your desk, you can set the same functions from the destination extension.

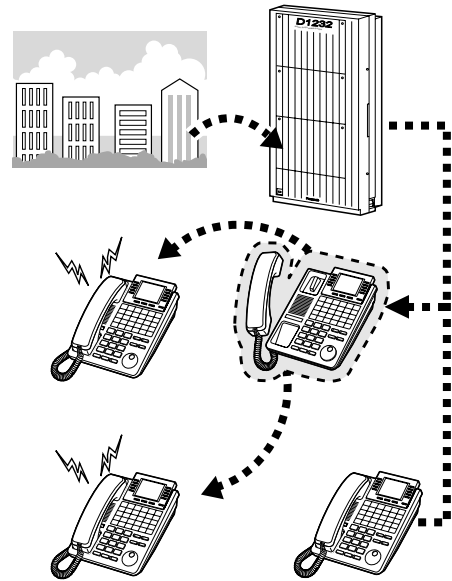

- You can set your mailbox or mobile telephone as the forwarding destination.

◆ To set

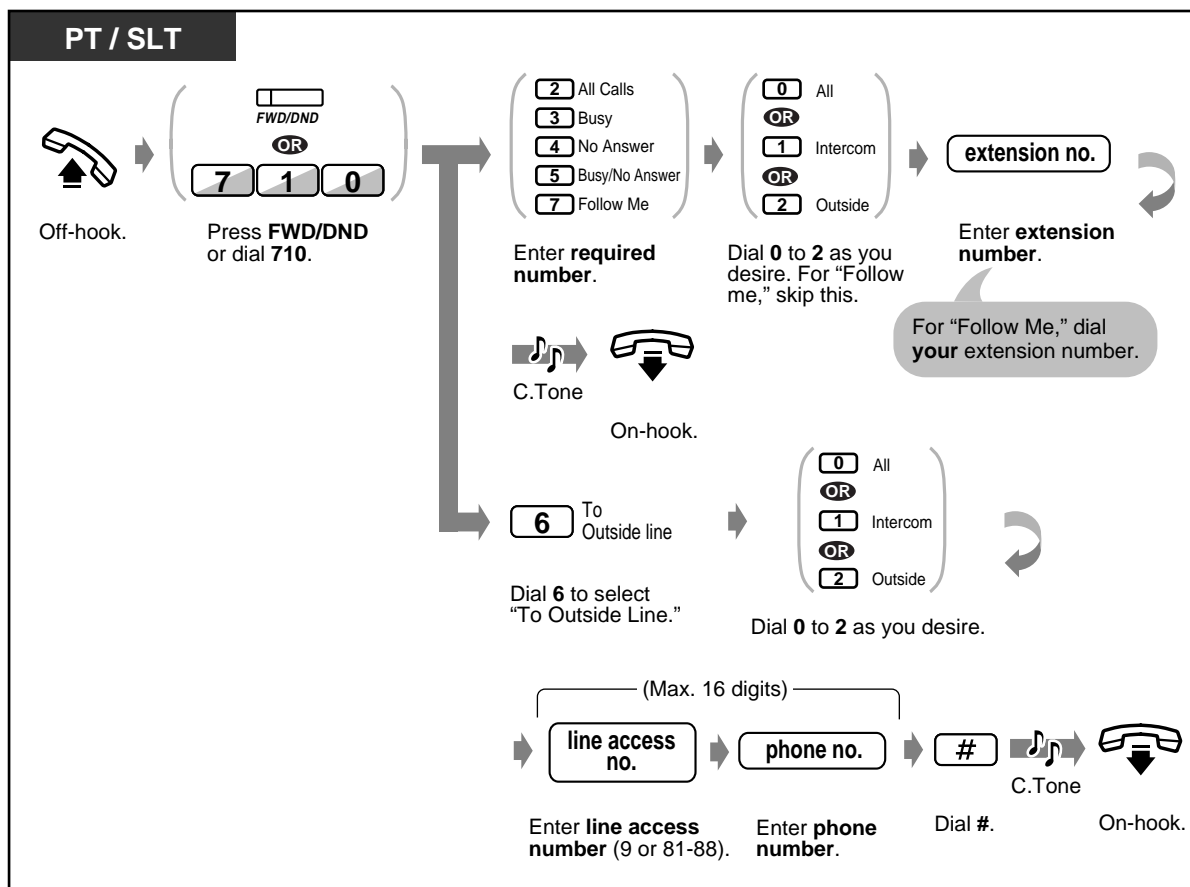

◆ To set (contd.)

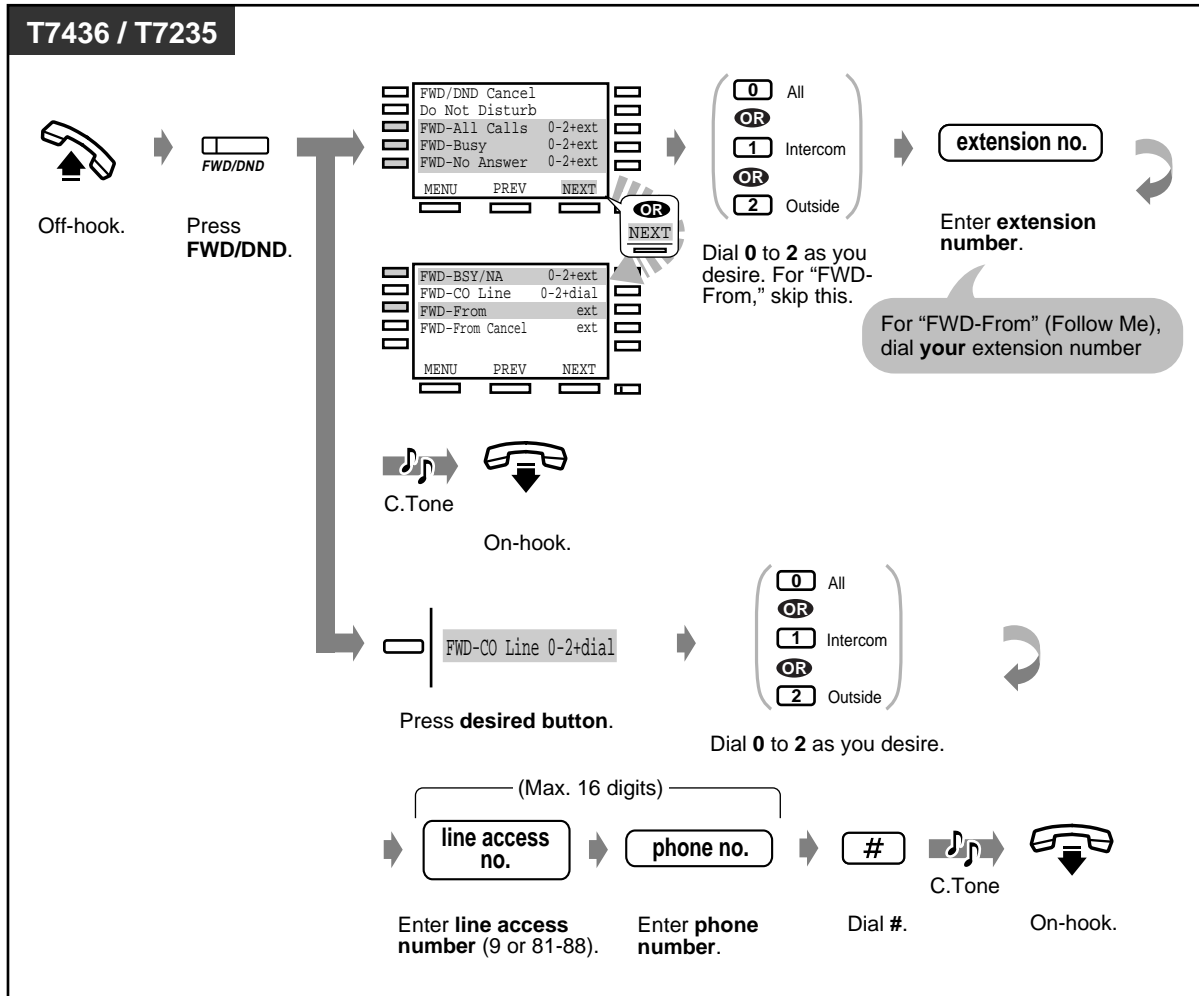

◆ To cancel

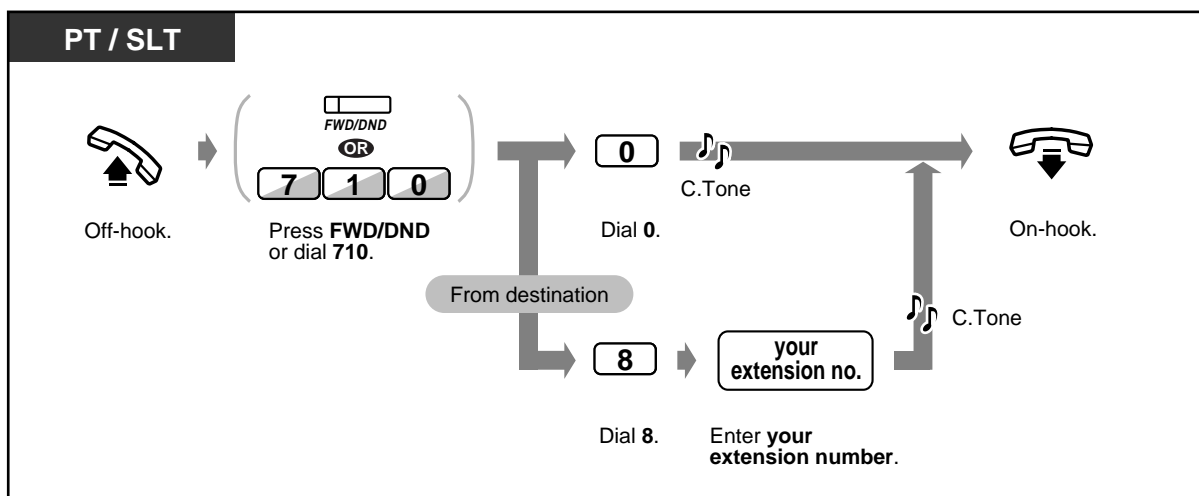

◆ To cancel (contd.)

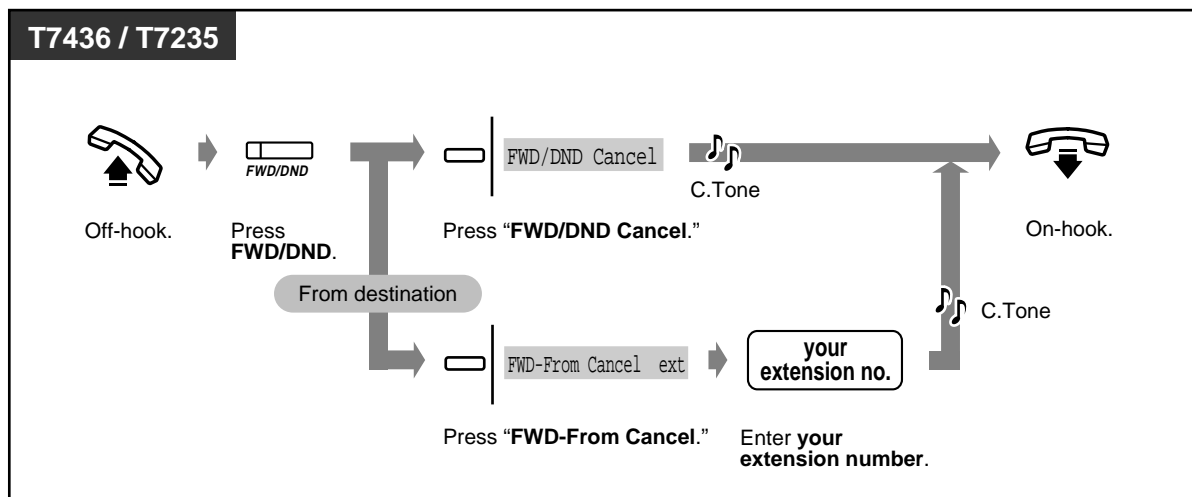

- A call can only be forwarded to one target telephone. For example, extension A's call is forwarded to extension B. Extension B's call is forwarded to extension C. A call to extension A is forwarded to extension B, but the call would not be forwarded directly to extension C from A.
- The extension which is set as the destination can call the original extension. (**Boss-Secretary function**)

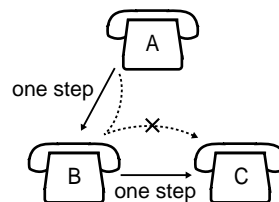

- You cannot set the "Do Not Disturb (DND)" and "Call Forwarding (FWD)" features at one time. Pressing the FWD/DND button while on-hook shows the destination depending on the setting as follows:

<Example>

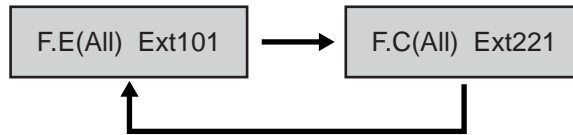

F : Call Forwarding
 E : from Extension (intercom)
 C : from CO Line (outside)
 (ALL)/(BSY)/(NA)/(B/NA)/(CO) : displays depending on the setting
 Extxxx/1234567& : destination

- The call transferred to your extension will also be forwarded to the appropriate destination depending on the type of call, intercom or outside.
- The FWD/DND button light shows the current status as follows:
 - Off:** Both features are not set.
 - Red on:** DND mode
 - Flashing red:** FWD mode
- This feature is not available for an ISDN telephone user.



Customising Your Phone

- 4.1.3 Customising the Buttons
 - Create or re-arrange a FWD/DND button.

2.5.2 Showing an Absent Message on the Caller's Telephone Display (Absent Message Capability)

You can show the reason for your absence, if the calling extension uses a Panasonic proprietary telephone with a display. This way the caller will know when you will be available. You can choose one of nine messages.

Message no.	Default Message
1	Will Return Soon
2	Gone Home
3	At Ext %%% (Extension number)
4	Back at %:% (Hour:Minute)
5	Out until %/% (Month/Day)
6	In a Meeting
7	
8	
9	



- Enter the desired value in the "%" space.
You must make your message in all of the "%"s using 0 to 9, #, or *.
- The message can be changed. Consult your dealer.

◆ To set

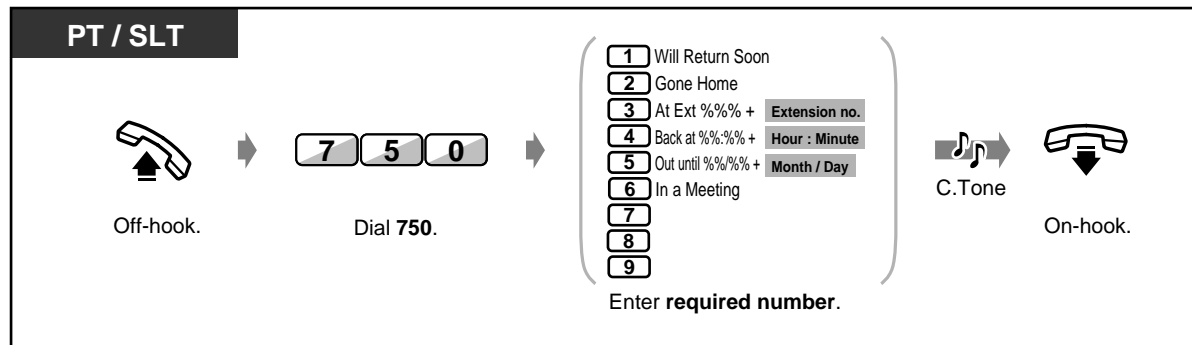

◆ **To set (contd.)**

T7433

Press **SHIFT** until "FEAT" is displayed.

Press "FEAT."

Rotate **Jog Dial** until "ABST MSG On" is at the arrow.

Press "SEL."

→ABST MSG On 1-9
C.Pickup GRP
MENU SEL

Enter required number.

- 1 Will Return Soon
- 2 Gone Home
- 3 At Ext %%% + Extension no.
- 4 Back at %:-%% + Hour : Minute
- 5 Out until %%% + Month / Day
- 6 In a Meeting
- 7
- 8
- 9

C.Tone

On-hook.

T7436 / T7235

Press "Features."

OR

Rotate **Jog Dial** or press "NEXT" until the following is displayed.

Press "Absent MSG On."

Absent MSG On (→1-9)

Enter required number.

- 1 Will Return Soon
- 2 Gone Home
- 3 At Ext %%% + Extension no.
- 4 Back at %:-%% + Hour : Minute
- 5 Out until %%% + Month / Day
- 6 In a Meeting
- 7
- 8
- 9

C.Tone

On-hook.

◆ **To cancel**

PT / SLT

Off-hook.

Dial **7500**.

C.Tone

On-hook.

◆ To cancel (contd.)

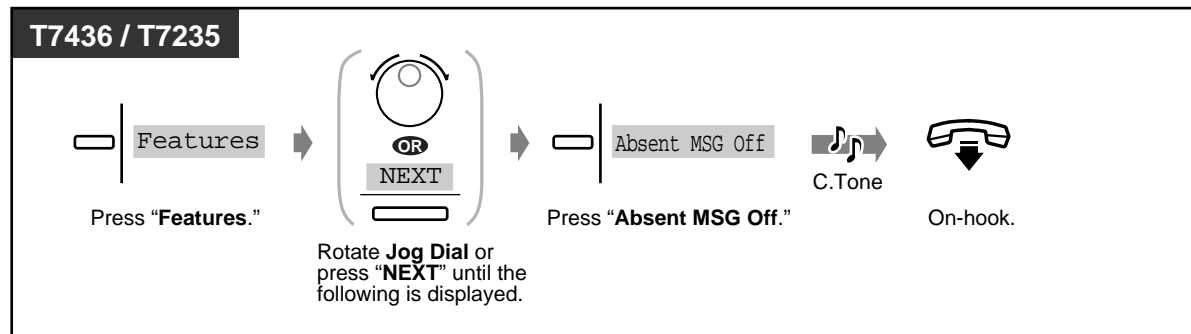
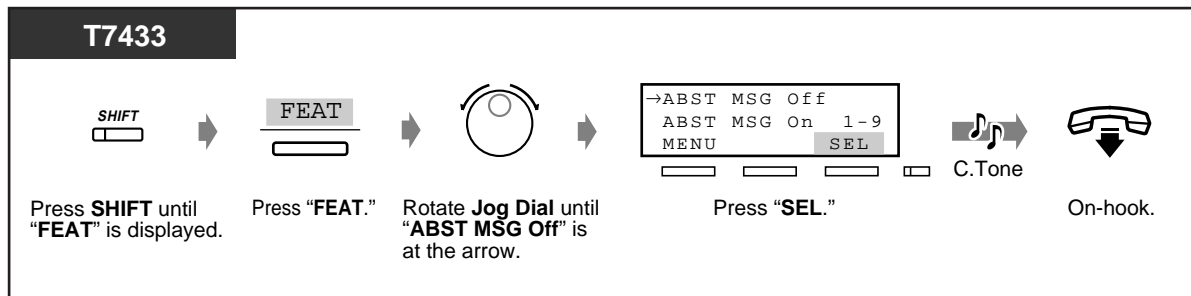

- **To confirm the message, go off-hook.**
It will be displayed.

2.5.3 Preventing Other People from Using Your Telephone (Electronic Station Lockout)



◆ To lock / unlock

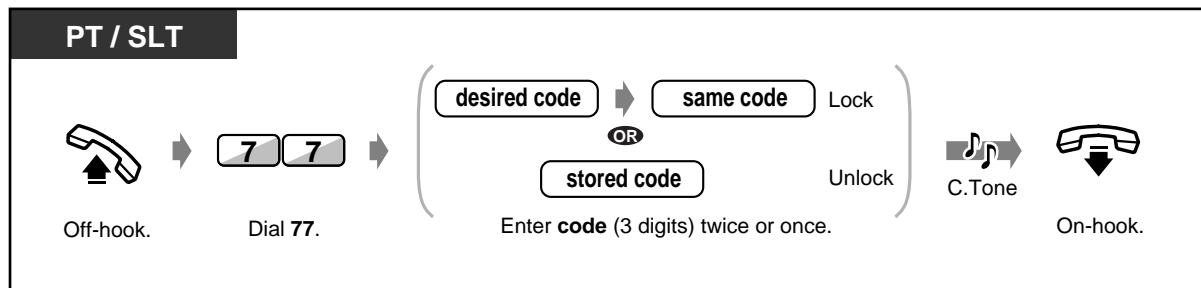

- **If you forget the code or cannot unlock your phone**, consult an operator. They can unlock your extension (Remote Station Lock Control).

2.5.4 Leaving a Call Distribution Group (Log-In / Log-Out)

You can set your status in a receiving group. Set Log-Out when you leave the office so that incoming calls will temporarily skip your extension in the receiving order. When you return, set Log-In so that calls will reach your extension. (Default: Log-In)

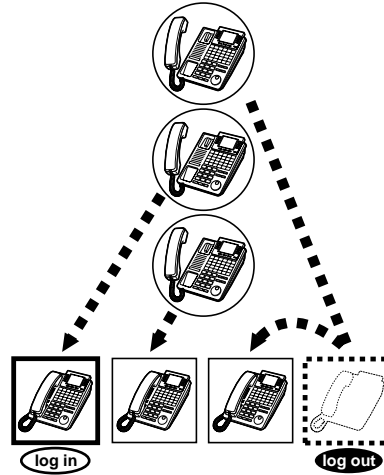

PT / SLT

Off-hook. → Dial 45. → Dial 0 to log-out or 1 to log-in. → C.Tone → On-hook.

The diagram shows the steps for PT / SLT: lifting the handset (Off-hook), dialing 45, dialing 0 for Log-Out or 1 for Log-In, hearing a C.Tone, and replacing the handset (On-hook).

T7433

Press **SHIFT** until "FEAT" is displayed. → Press "FEAT." → Rotate **Jog Dial** until "Login/out" is at the arrow. → Press "SEL." → Dial 0 to log-out or 1 to log-in. → C.Tone → On-hook.

The diagram shows the steps for T7433: pressing SHIFT until FEAT is displayed, pressing FEAT, rotating the Jog Dial until Login/out is at the arrow, pressing SEL, dialing 0 for Log-Out or 1 for Log-In, hearing a C.Tone, and replacing the handset (On-hook).

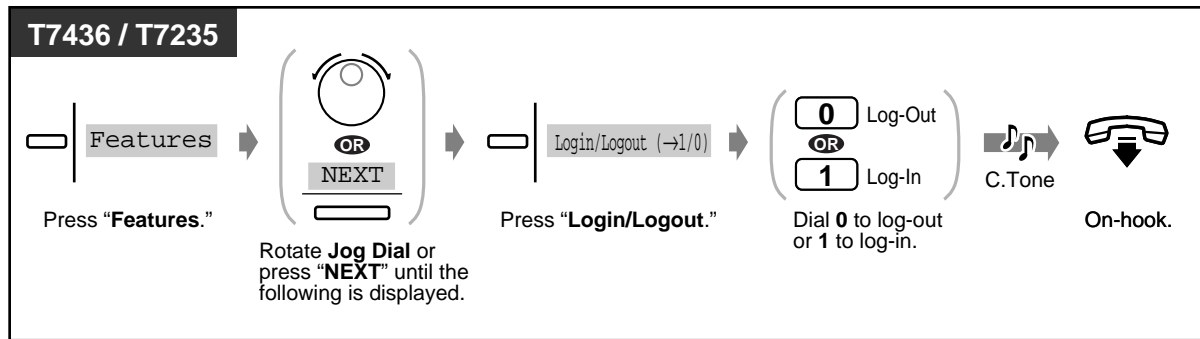

- The Log-In / Log-Out button alternates the setting between Log-In and Log-Out modes. The button light shows the current status as follows:

Off: Log-In mode

Red on: Log-Out mode

Flashing red: a call waiting for UCD (a receiving group)

- There should be at least one extension in the receiving group that is in the Log-In mode.
- This feature is not available for an ISDN telephone user.



Customising Your Phone

4.1.3 Customising the Buttons

Create or re-arrange a Log-In / Log-Out button.

2.6 Making / Answering an Announcement

2.6.1 Paging

You can make a voice announcement to several people at the same time. Your message is sent over the proprietary telephone speakers and/or external speakers. The paged person can answer your paging from any telephone. There are three types as shown below:

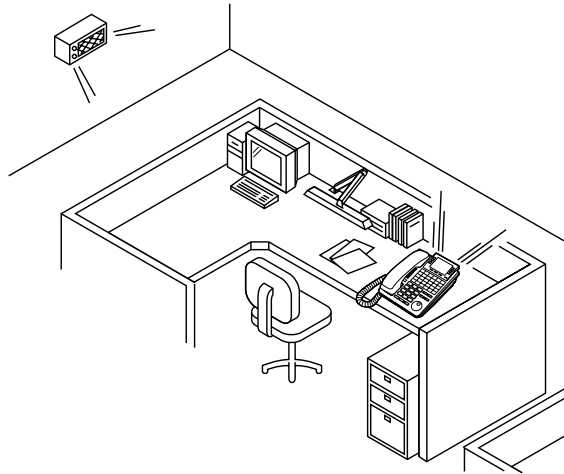

All:

Paging through both the telephone speakers and external speakers.

External:

Paging through the external speakers.

Group:

Paging to a particular extension group or all groups (all extensions) through the telephone speakers.

◆ **All**

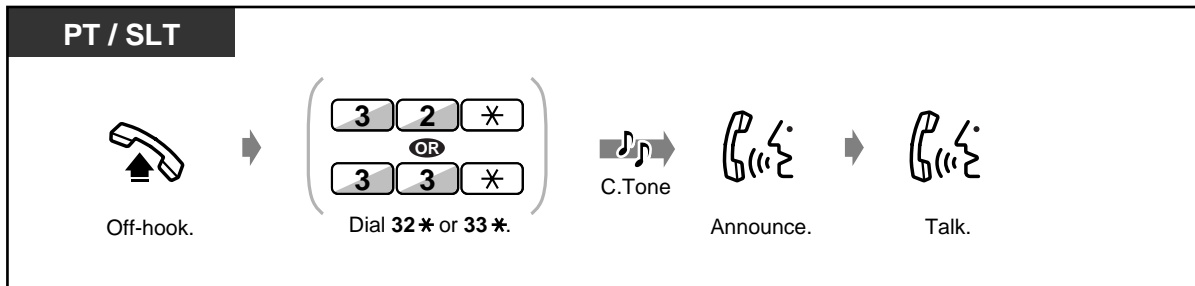

◆ **External**

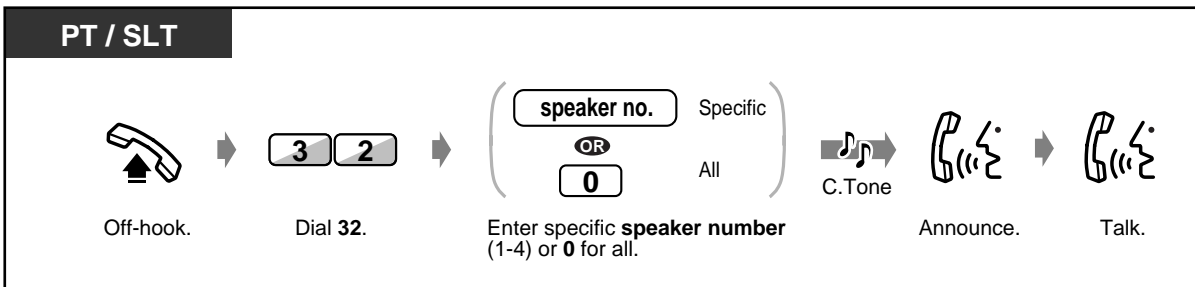

◆ External (contd.)

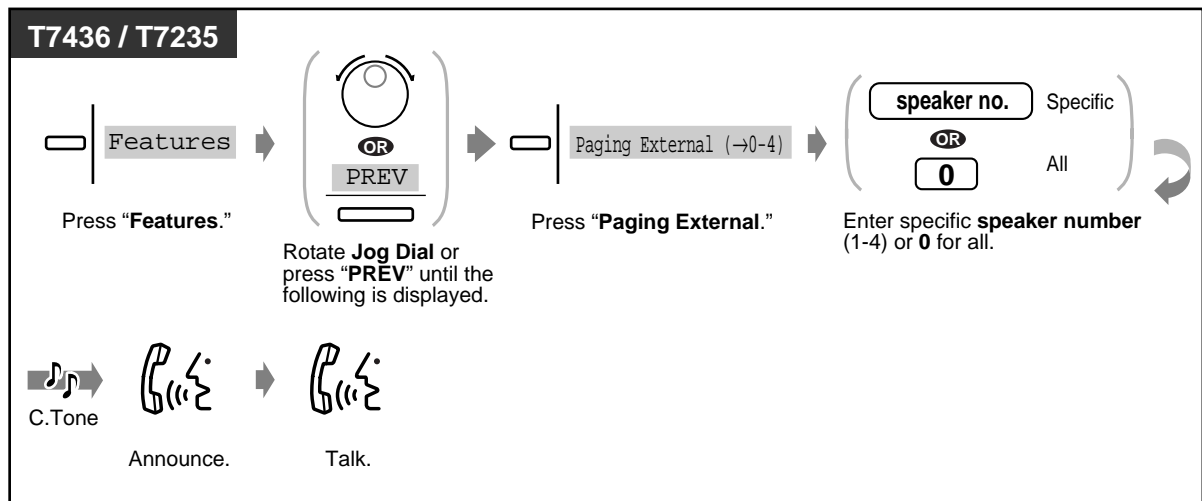
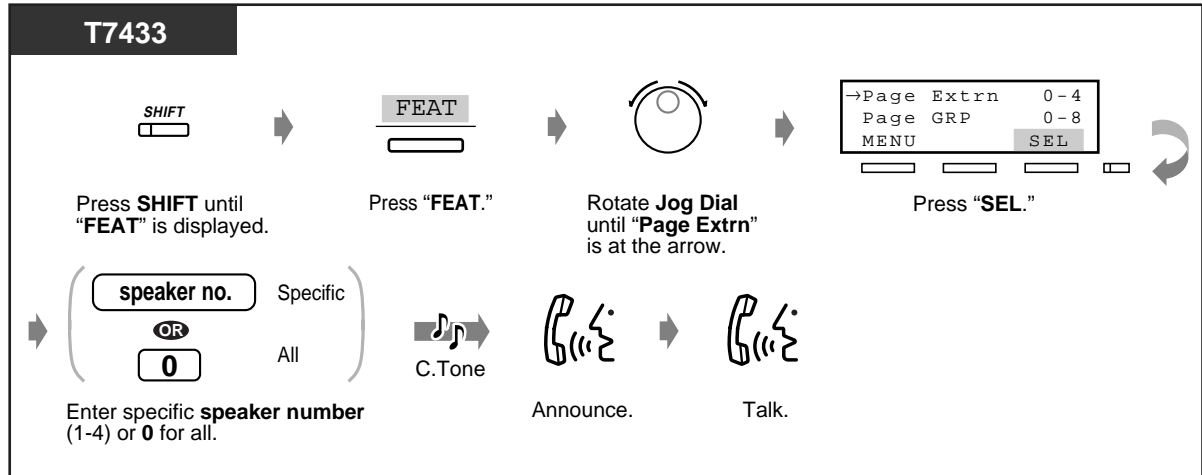

◆ Group

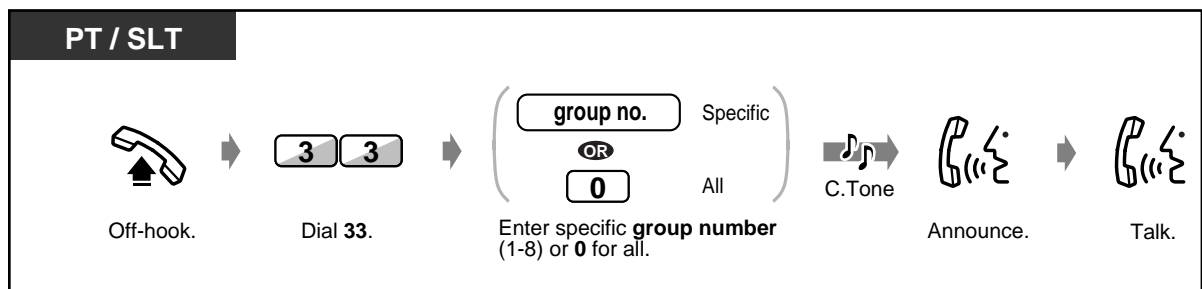

◆ **Group (contd.)**

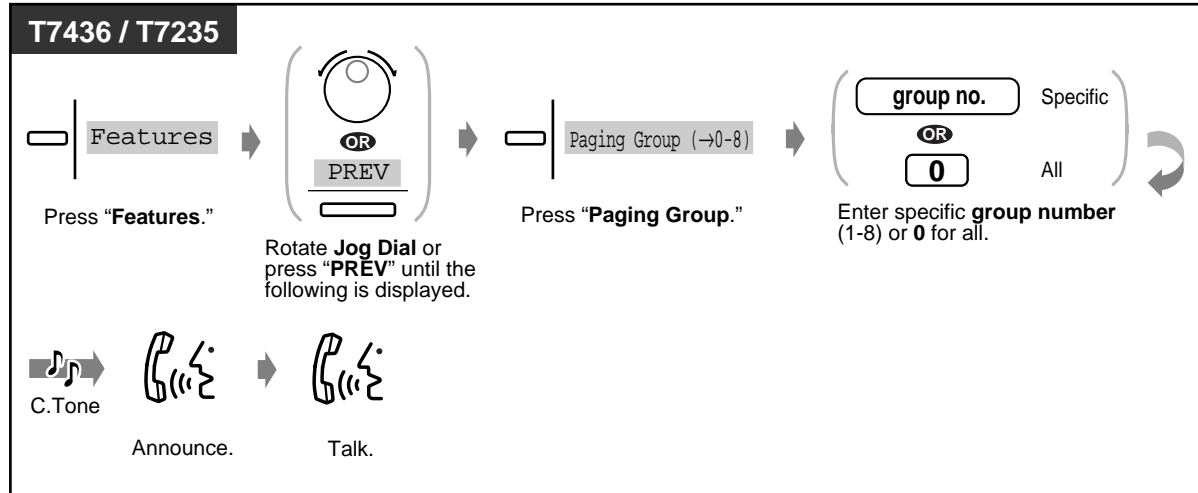
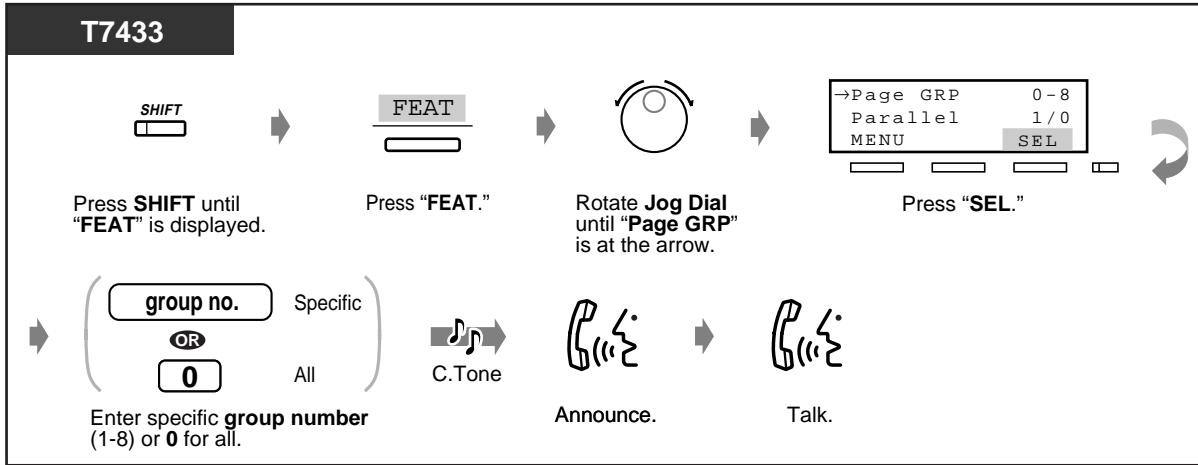

- A ringing, busy, Do Not Disturb extension, or a single line telephone cannot receive a paged announcement.

2.6.2 Paging a Person and Transferring a Call

◆ Through a speaker and telephones

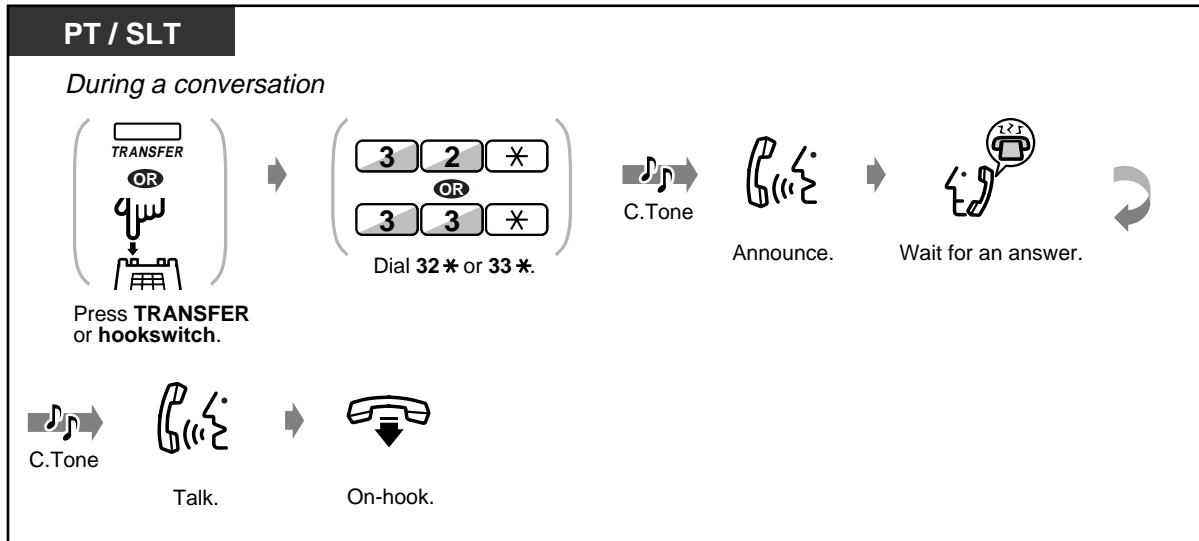

◆ Through a speaker

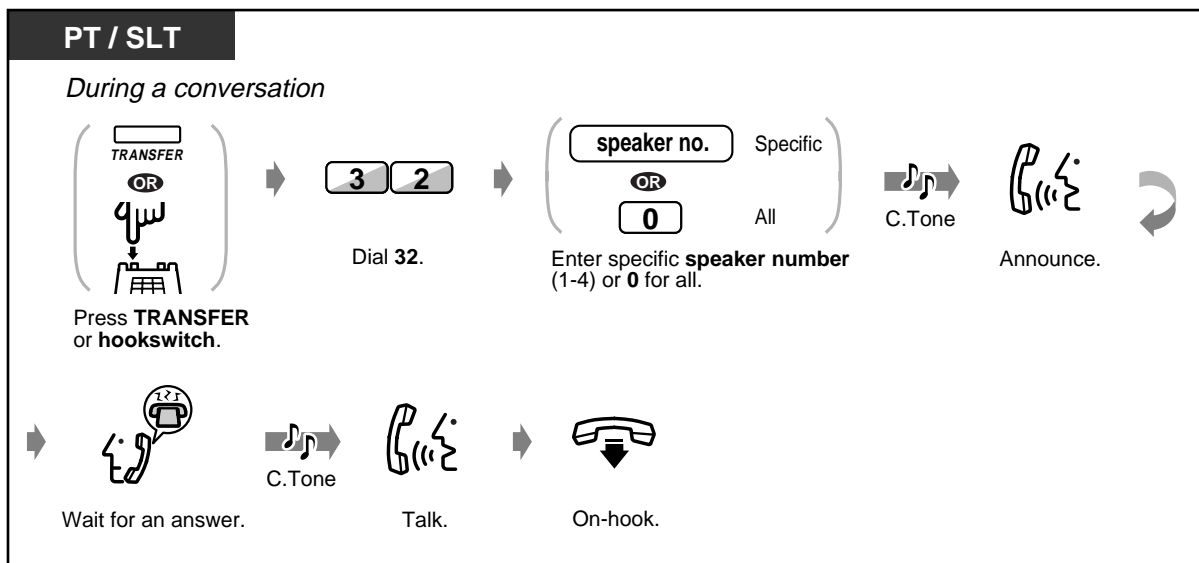

◆ **Through the telephones of a particular extension group**

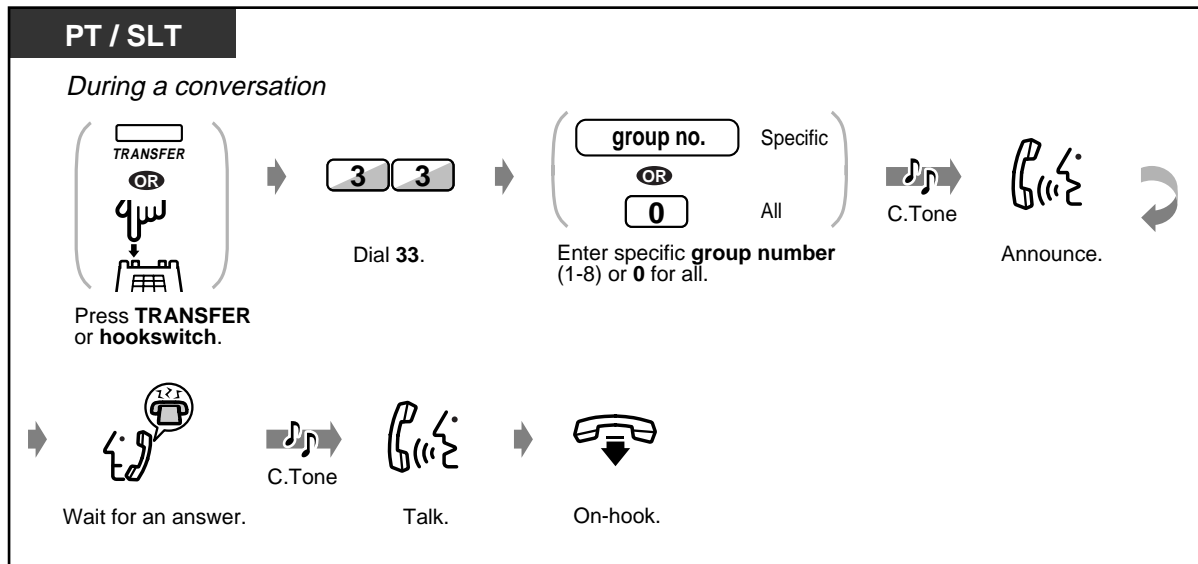

2.6.3 Answering a Paged Announcement

◆ Through a speaker

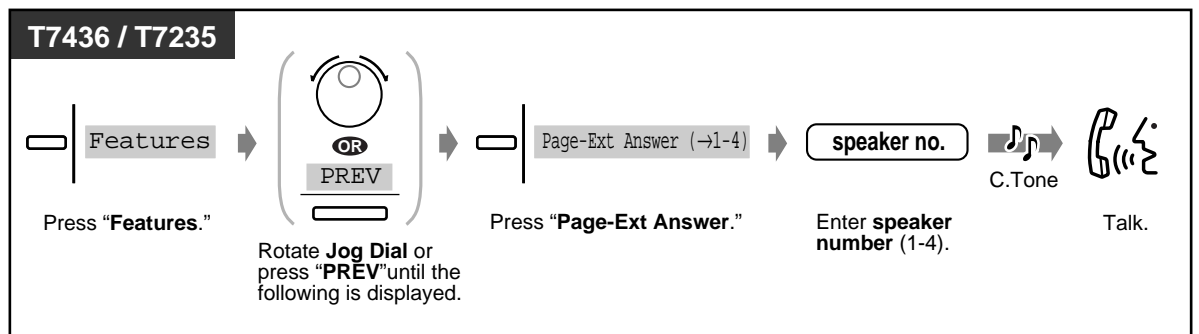
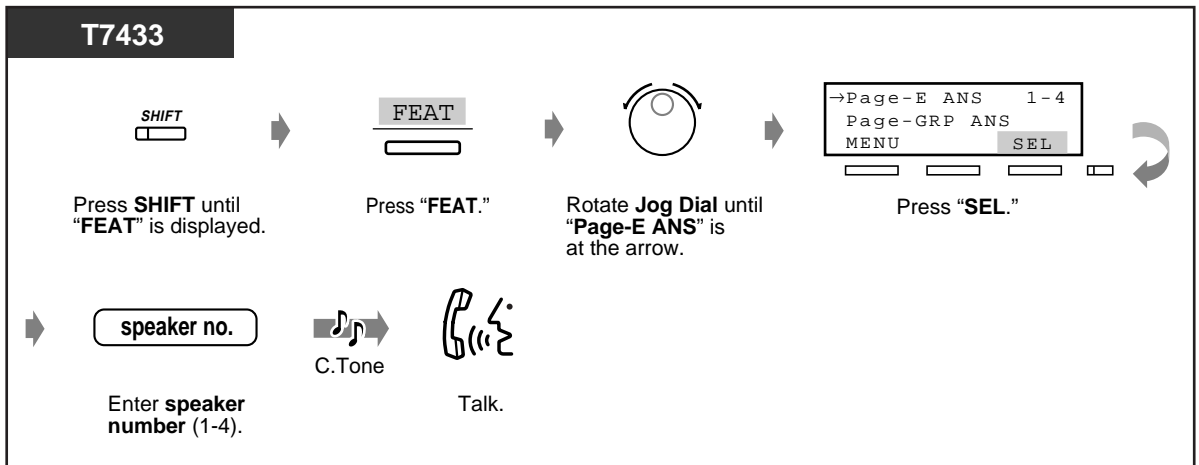
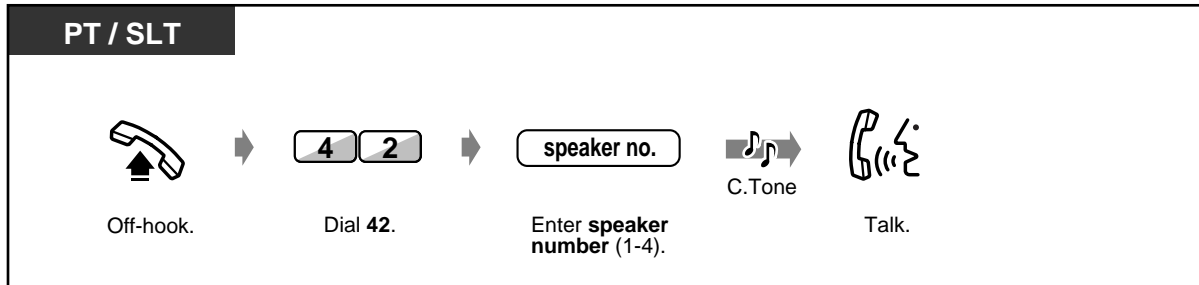

◆ Through the telephones

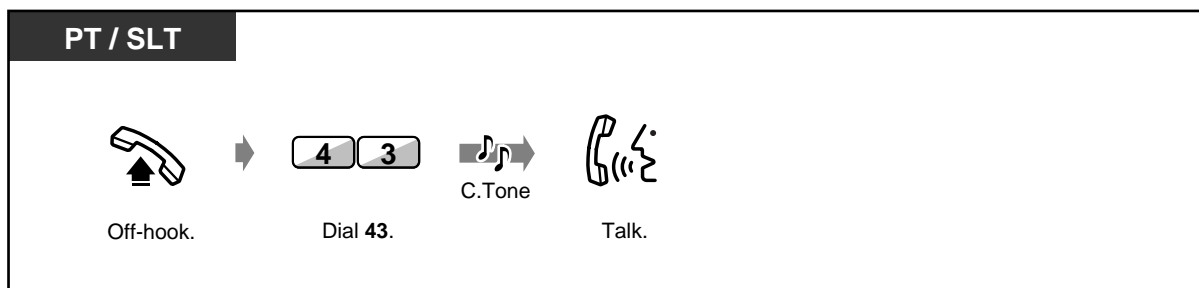

◆ **Through the telephones (contd.)**

T7433

Off-hook. Press **SHIFT** until "FEAT" is displayed. Press "FEAT." Rotate **Jog Dial** until "Page-GRP ANS" is at the arrow. Press "SEL."

→Page-GRP ANS
Page Extrn 0-4
MENU SEL

C.Tone
Talk.

T7436 / T7235

Press "Features." Rotate **Jog Dial** or press "PREV" until the following is displayed. Press "Page-GRP Answer." C.Tone Talk.

Features
OR
PREV
Page-GRP Answer

C.Tone
Talk.



- This feature is not available for an ISDN telephone user.

2.7 Setting the Telephone According to Your Needs

2.7.1 Setting the Alarm (Timed Reminder)

You can receive a ringback alarm at your telephone to remind you of a meeting, appointment or as a wake-up call. The setting can be for either one time or daily (every day until cancelled) at a pre-set time.

◆ To set

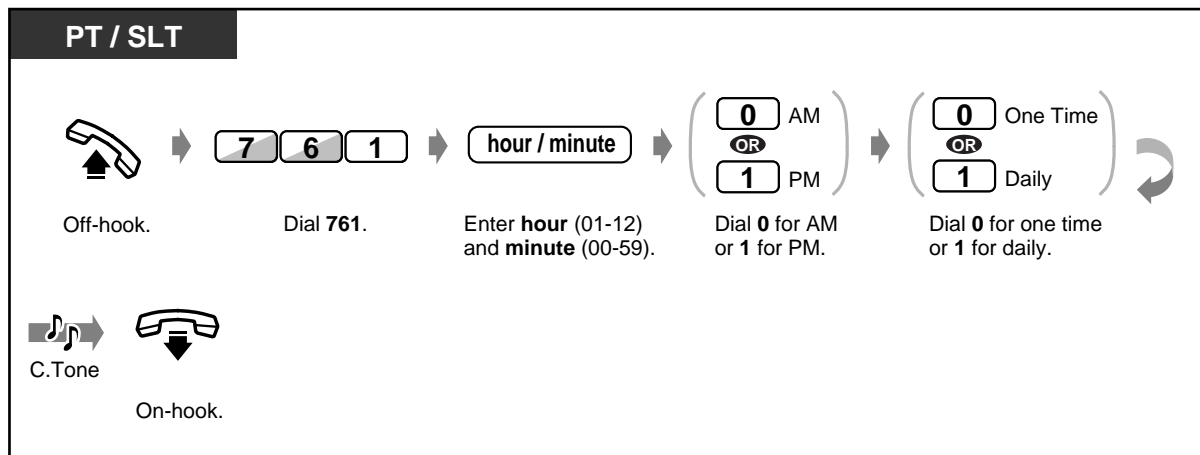

◆ To cancel

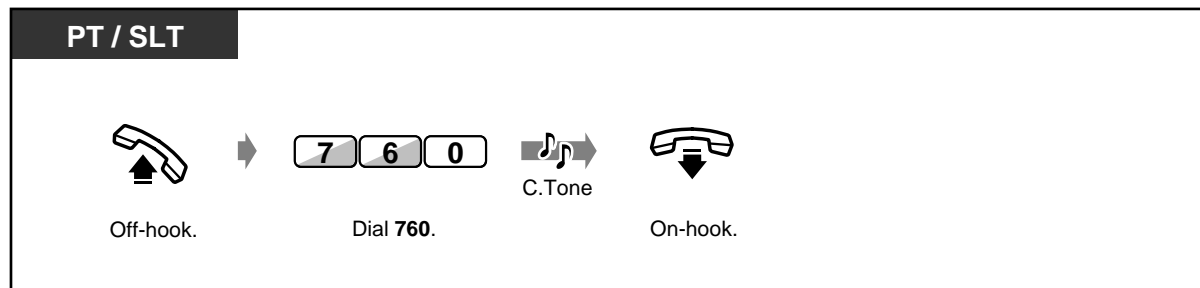

◆ To view the setting

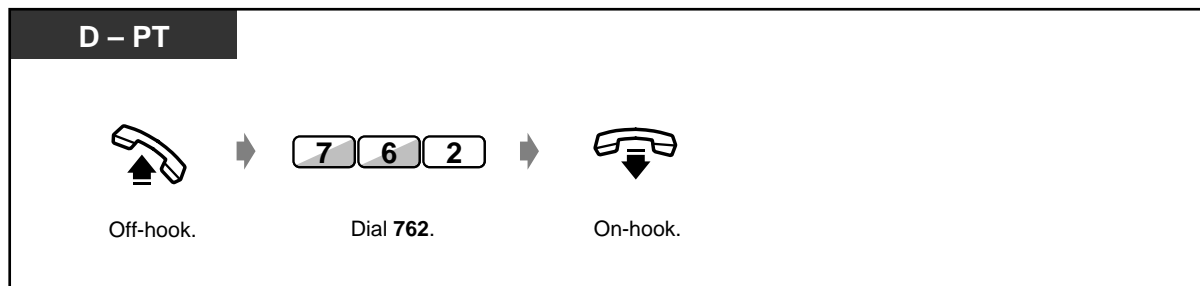

◆ **To stop or answer the ringback**

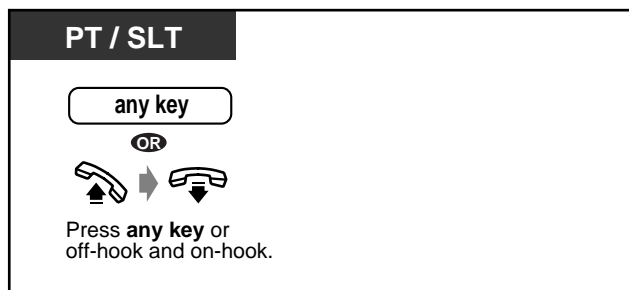

- The alarm tone keeps ringing for thirty seconds.
- **If you receive an incoming call during ringback**, ringing starts after the ringback stops.
- **If you are having a conversation during the pre-set time**, the ringback will start after your conversation.
- This feature is not available for an ISDN telephone user.
- If you go off-hook to answer, you can hear the alarm tone or the recorded message which the operator pre-assigned.



When the daily alarm is set, the display shows "*" in the corner.

Alarm 10:10AM*

2.7.2 Refusing Incoming Calls (Do Not Disturb [DND])

You may set this feature during a meeting or when you are busy.

◆ To set / cancel

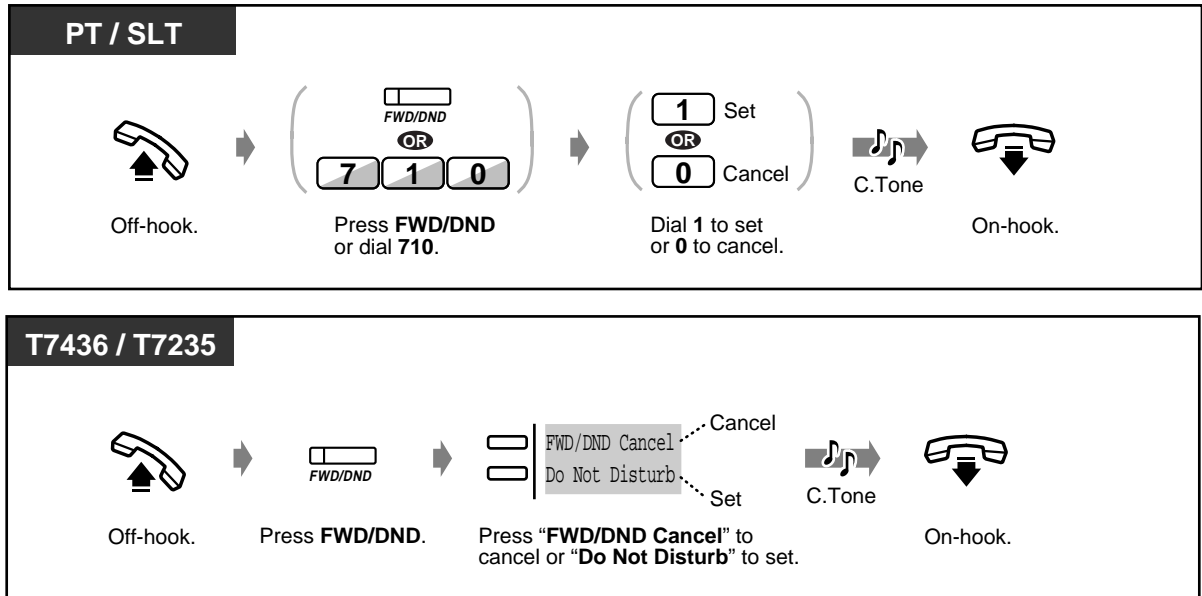

- A flashing CO button tells you an outside call is received. You can answer the call by pressing the CO button.
- You cannot set the "Do Not Disturb" and "Call Forwarding" features at one time.
- Specified extensions can override this setting and call DND extensions (Do Not Disturb Override).
- The FWD/DND button light shows the current status as follows:
 - Off:** Both features are not set.
 - Red on:** DND mode
 - Flashing red:** FWD mode
- This feature is not available for an ISDN telephone user.



Customising Your Phone

- 4.1.3 Customising the Buttons
Create or re-arrange a FWD/DND button.

2.7.3 Receiving a Call Waiting (Call Waiting / Off-Hook Call Announcement [OHCA] / Whisper OHCA)

During a conversation, you can be informed a call waiting with a tone or voice announcement through your speaker or handset. (Default: No tone)

Call waiting tone:

a waiting tone through the handset. You can change the tone, refer to 4.1 Customising Your Phone (Station Programming).

OHCA:

a voice announcement through the speaker without pre-information (KX-T7436 and KX-T7235 telephone users only)

Whisper OHCA:

a voice announcement through the handset without pre-information (KX-T7400 series telephone users only)

◆ **To set / cancel**

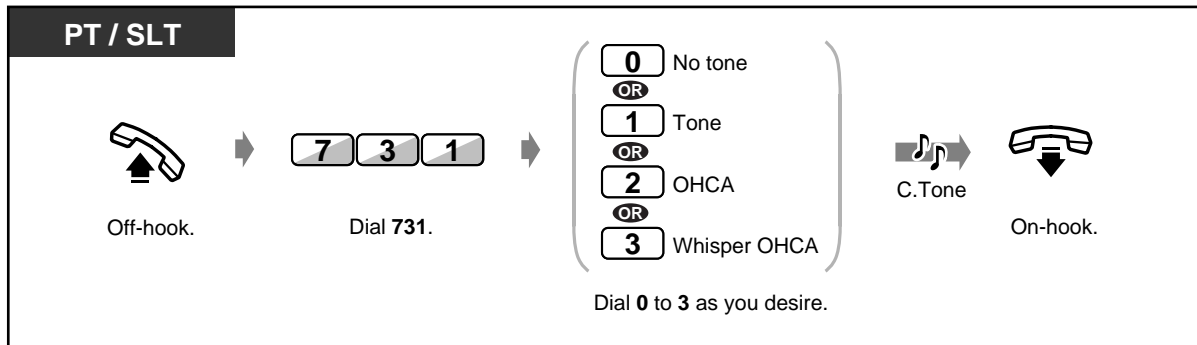

- Only KX-T7400 series telephone users can send or receive Whisper OHCA.
- This feature is not available for an ISDN telephone user.

2.7.4 Displaying Your Number on the Called Party and Calling Party's Telephone (Calling / Connected Line Identification Presentation [CLIP / COLP])

CLIP :

When making an outside call, you can let the other party show your pre-assigned identification number.

COLP :

When receiving an outside call, you can let the party calling you show your pre-assigned identification number.

You can select to show an identification number assigned for an outside line or your extension.

◆ To show an identification number assigned for an outside line or your extension

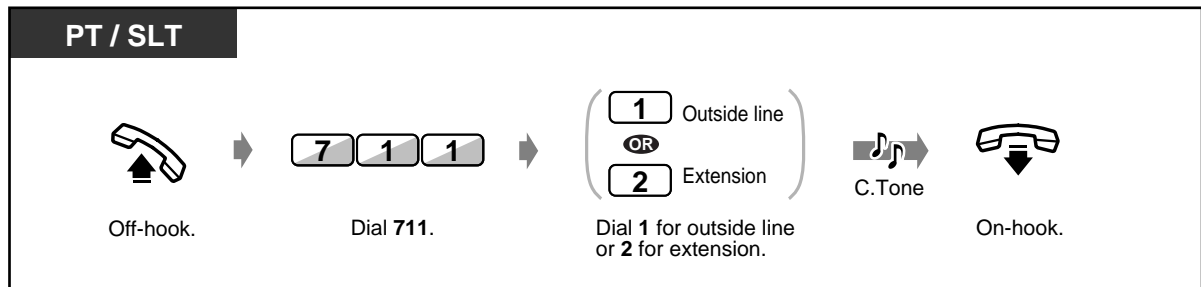

- The system is in accordance with ETS specifications below.
 ETS 300 092 Calling Line Identification Presentation (CLIP) supplementary service
 ETS 300 093 Calling Line Identification Restriction (CLIR) supplementary service
 ETS 300 097 Connected Line Identification Presentation (COLP) supplementary service
 ETS 300 098 Connected Line Identification Restriction (COLR) supplementary service
 ETS: European Telecommunication Standard
- The entered identification number must match the conditions of your telephone company. Otherwise it might be ignored or replaced by another value.

2.7.5 Denying Other People the Possibility of Picking up Your Calls (Call Pickup Deny)

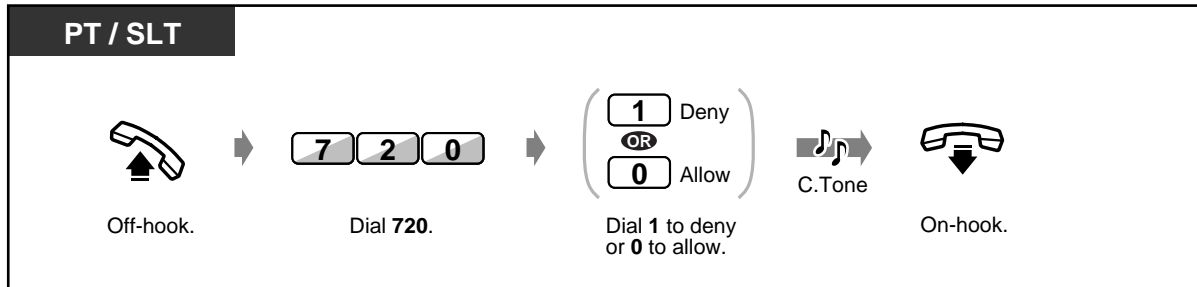

2.7.6 Denying Other People the Possibility of Joining Your Conversation (Executive Busy Override Deny)

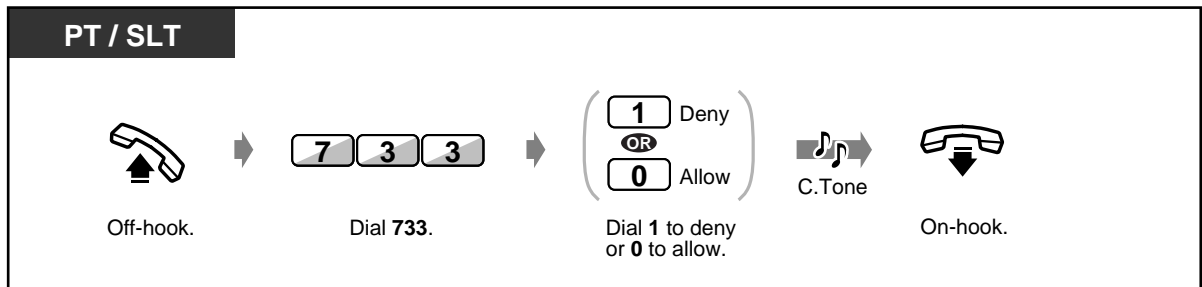

- This feature is not available for an ISDN telephone user.

2.7.7 Turning on the Background Music

You can listen to background music through your telephone speaker while on-hook. An external music source, such as a radio, must be connected.



◆ To set / cancel

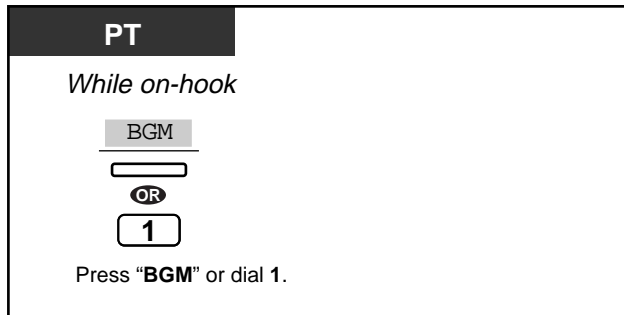

- You can select the mode by pressing "BGM" or dialing 1 repeatedly as follows:
Music 1 → Music 2 → BGM Off

2.7.8 Protecting Your Line against Indication Tones (Data Line Security)

You can protect the line against indication tones, such as call waiting tone or interruptions (Executive Busy Override). Set this feature if your extension is connected to a data communication device, such as a computer or facsimile, to secure data transmission.

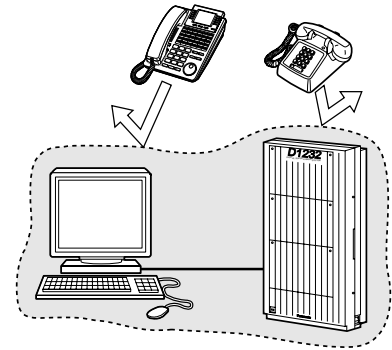

◆ To set / cancel

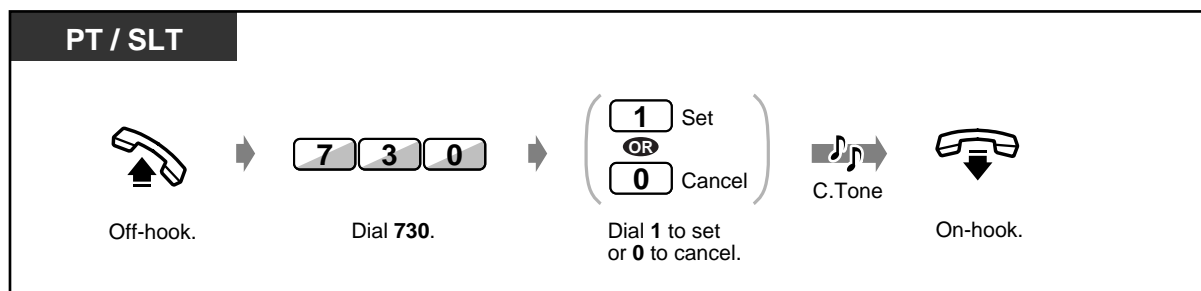

- This feature is not available for an ISDN telephone user.

2.7.9 Checking the Day / Night Service Status

You can manage your system under different conditions for either day time (business hours) or night time (after business hours).



D – PT

While on-hook

#

OR

[]
(Night)

Dial # or press **Night**.

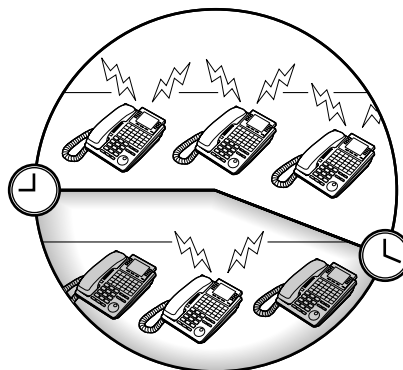

- Any extension user can check the status. In this case, only extension users except the operators can check it by pressing the Night button.
- The Night button light shows the current status as follows:

Off: Day mode

Red: Night mode



Customising Your Phone

- 4.1.3 Customising the Buttons
Create or re-arrange a Night button.

2.7.10 Setting the Parallel Connected Telephone Ringer (Paralleled Telephone)

A proprietary telephone user can choose whether the single line telephone connected in parallel will ring or not, when an incoming call is received. (Default: No ring)

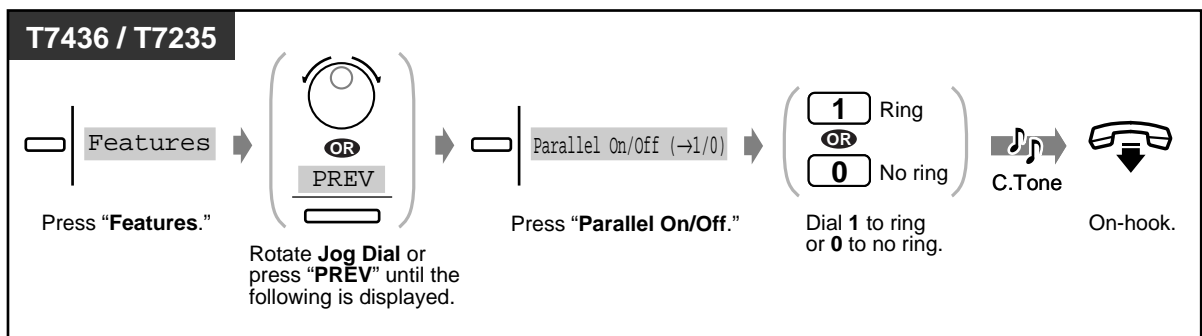
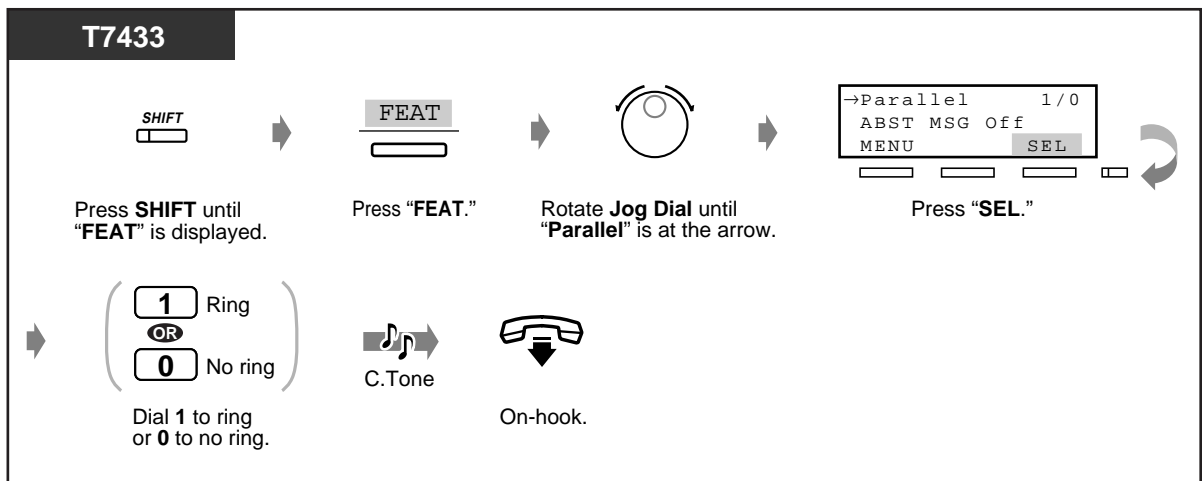
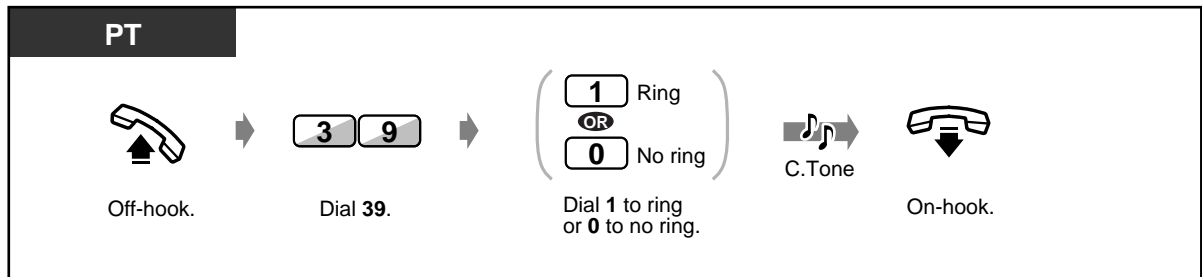

- **Even if "No ring" is selected**, the call can be answered with the single line telephone by lifting the handset.
- If you go off-hook while your paralleled telephone is in use, the call will switch over to your telephone, and vice versa.
- This feature is not available for an ISDN telephone user.

2.7.11 Clearing the Feature Settings at Your Extension (Station Programme Clear)

You can clear the following features which have been set on your phone. If you change desks, and notice settings which a previous owner left on the line, you can clear these features.

- Calling to a Pre-set Party by Going Off-Hook (Pickup Dialling): The stored number will be cleared.
- Leaving a Message Waiting Indication (Message Waiting): All messages will be removed.
- Forwarding Your Calls (Call Forwarding)
- Showing an Absent Message on the Caller's Telephone Display (Absent Message Capability)
- Leaving a Call Distribution Group (Log-In/Log-out)
- Calling Using the Call Log (Incoming Call Log)
- Setting the Alarm (Timed Reminder)
- Refusing Incoming Calls (Do Not Disturb [DND])
- Receiving a Call Waiting (Call Waiting / Off-Hook Call Announcement [OHCA] / Whisper OHCA)
- Denying Other People the Possibility of Picking up Your Calls (Call Pickup Deny)
- Denying Other People the Possibility of Joining Your Conversation (Executive Busy Override Deny)
- Turning on the Background Music
- Protecting Your Line against Indication Tones (Data Line Security)
- Setting the Parallel Connected Telephone Ringer (Paralleled Telephone): The single line telephone will not ring.

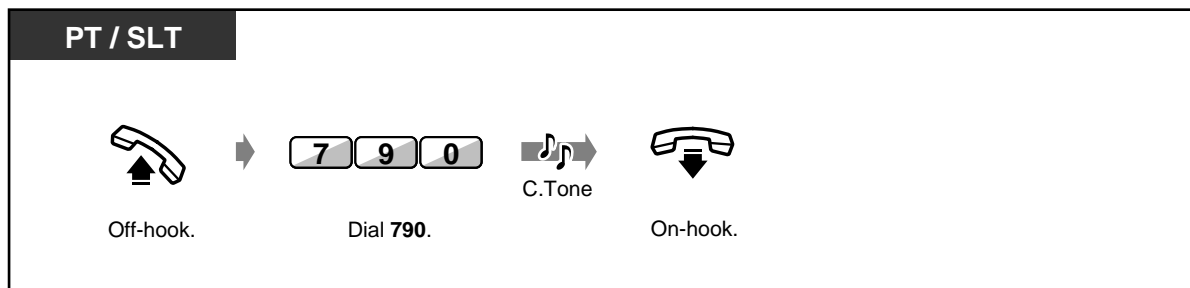

2.8 Using User-supplied Equipment

2.8.1 If a Doorphone / Door Opener is Connected

— Doorphone call

— Opening the door

◆◆ Doorphone call

◆ To call from the doorphone

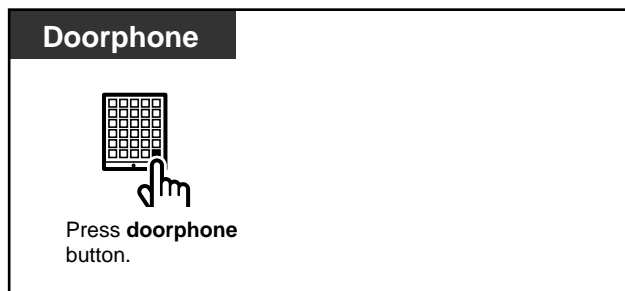

◆ To call the doorphone

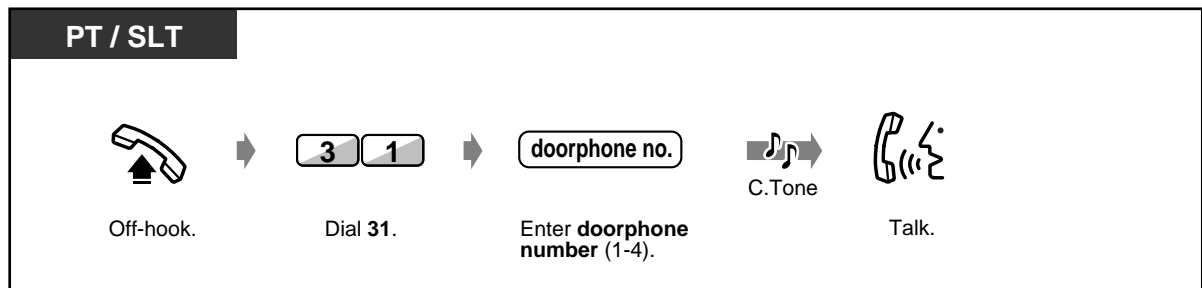

◆◆ Opening the door

Some extensions may be restricted from performing this function.

◆ From a specified extension

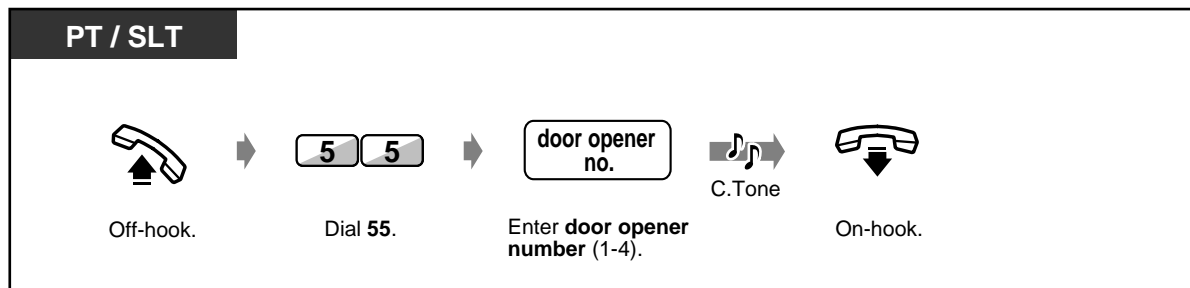

◆ From any extension while talking to the doorphone

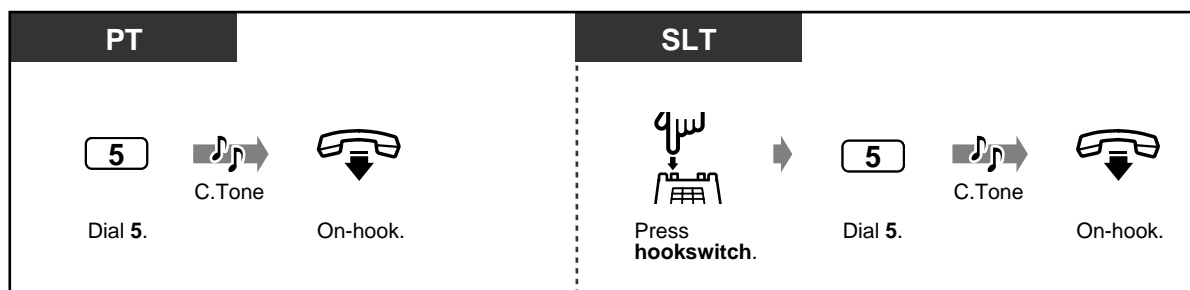

- The door will be left open for five (three) seconds. (Default: 5 seconds)
- You can change the time to keep the door open. Please consult your manager and dealer.
- **To keep the door open for another five (three) seconds**, dial 5 again using a Panasonic proprietary telephone.
- **If no one answers the doorphone call within 30 seconds**, the call is cancelled.

2.8.2 If a Host PBX is Connected

◆◆ Accessing external services (External Feature Access)

You can access special features (e.g. Call Waiting) offered by a host PBX or Central Office. This feature is only effective with an outside call.

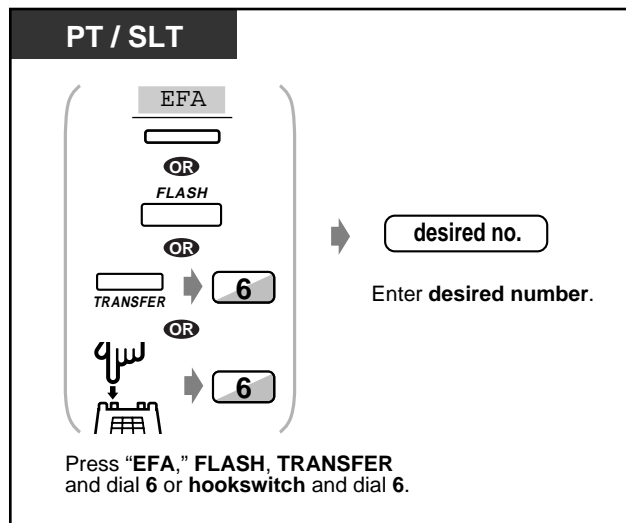
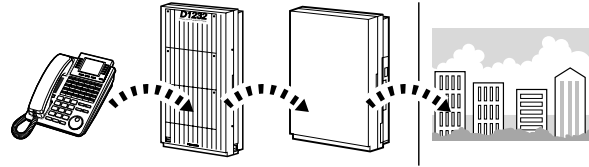

- If you programme "EFA" (External Feature Access) to the FLASH button by system programming, it is used to send a flash signal to a host PBX or Central Office. For more details, consult your manager or dealer.

2.8.3 If a Voice Processing System is Connected

— Voice mail integration

If your system is connected to a Panasonic Voice Processing System (e.g. KX-TVP100) which can be used with a digital proprietary telephone, the following functions are available:

— Screening calls

— Recording a conversation

◆◆ Voice mail integration

If you cannot answer calls, you can forward them to your mailbox by selecting type of incoming call (all/intercom/outside). If your telephone has a MESSAGE button, the button light turns on and lets you know you have messages. Even if a MESSAGE button is not provided, you will hear an indication tone* when going off-hook.

You can also transfer received outside calls to a certain mailbox so that callers can leave messages. If you create a Voice Mail Transfer button on your phone, the transfer is done easily without confirming the voice mail extension number (Voice Mail Transfer).

◆ To forward your calls to a mailbox

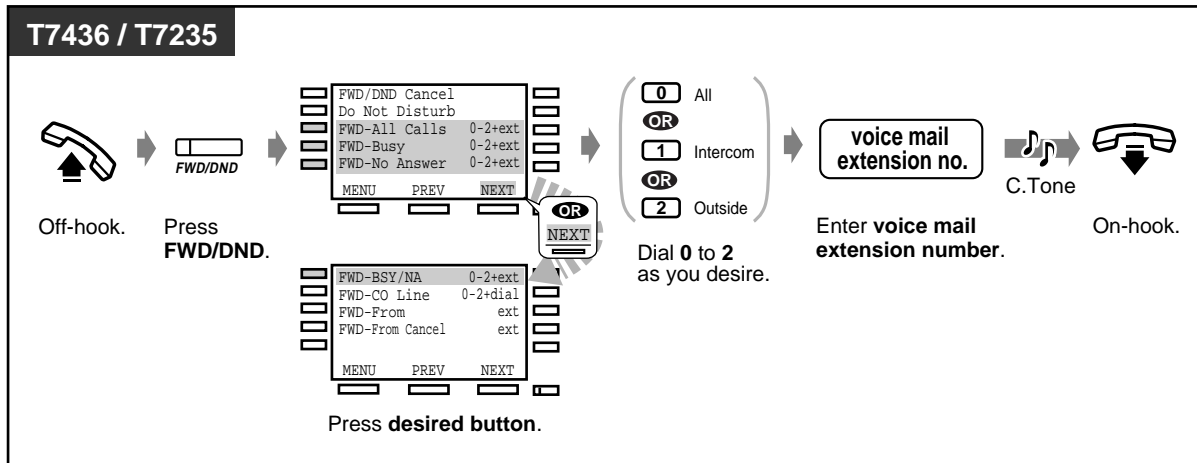
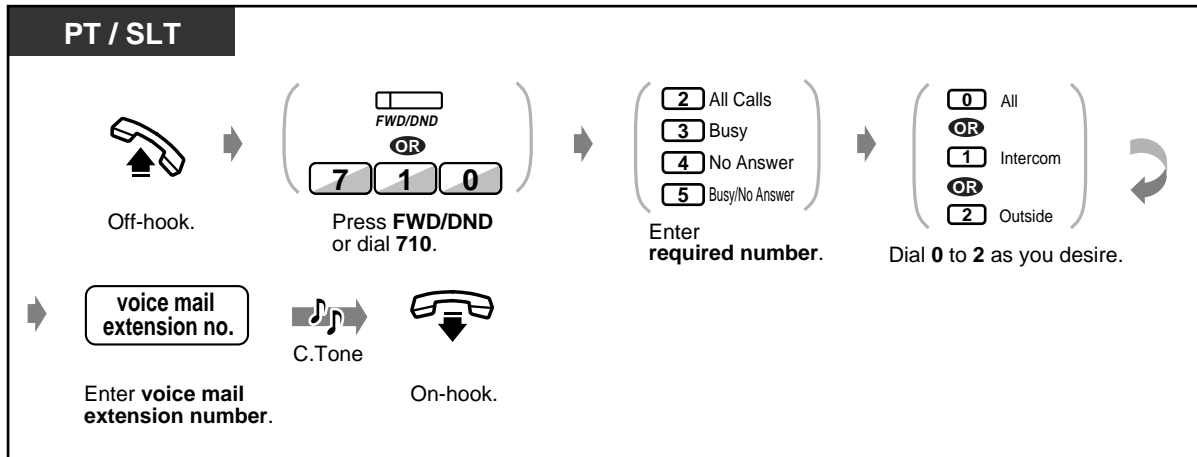

◆ Transferring calls

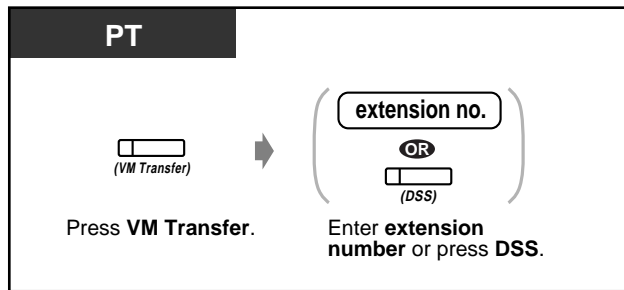

◆ To listen to a stored message

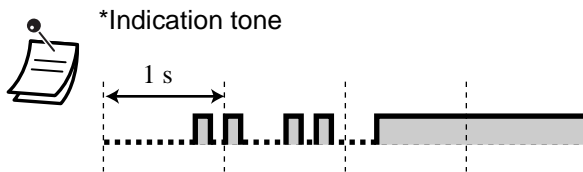
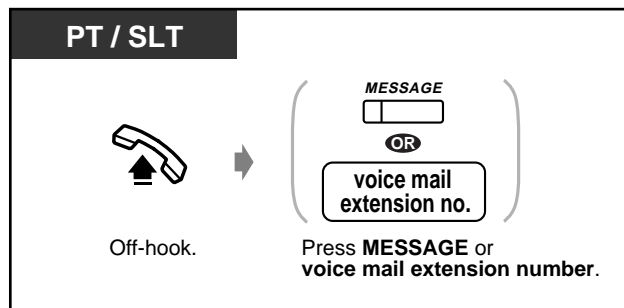

✎ Customising Your Phone

- 4.1.3 Customising the Buttons
Create or re-arrange a MESSAGE button and Voice Mail (VM) Transfer button.

◆◆ Screening calls (Live Call Screening [LCS])

While a caller is leaving a message in your mailbox, you can monitor the call. If desired, you can answer the call while monitoring. There are two methods available (Default: Hands-free mode). In both modes, if you are currently having a conversation, you will hear a call waiting tone.



Hands-free mode:

You can monitor the message automatically through the telephone speaker at the same time.

Private mode:

You will hear an alert tone while the caller is leaving a message.

Before operating

- Create a Live Call Screening (LCS) button (Personal Programming).
- Select the mode, either Hands-free or Private (Personal Programming).
- Set the Password.
- Set the Live Call Screening feature.

◆ **To set / cancel the password**

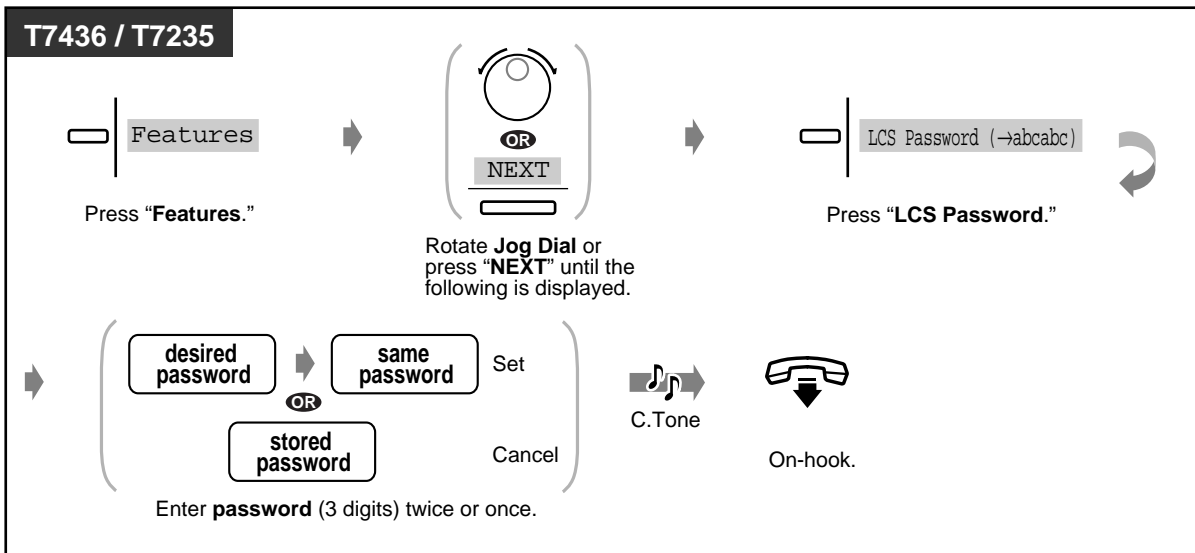
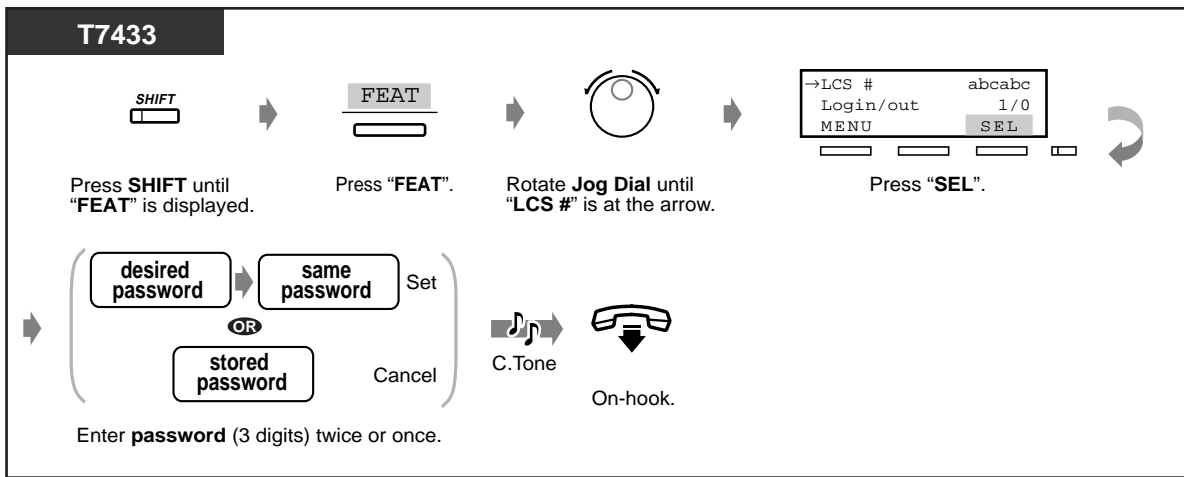
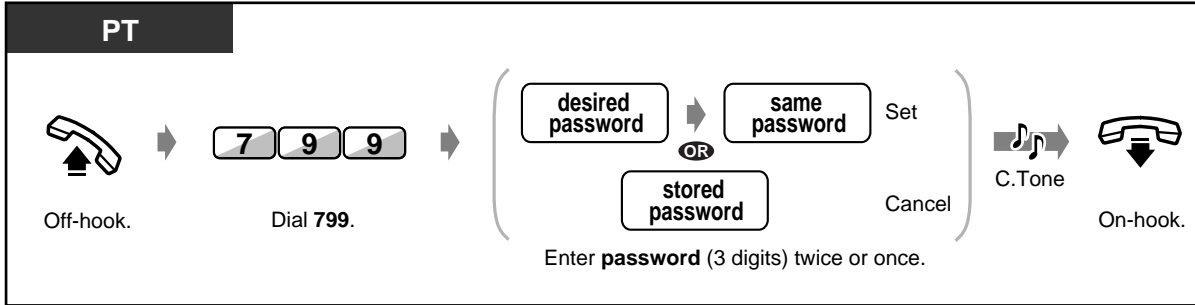

◆ **To set Live Call Screening**

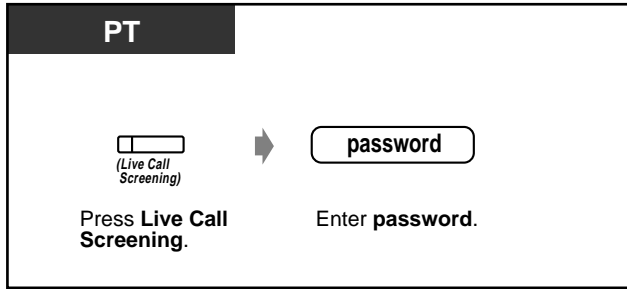

◆ **To cancel Live Call Screening**

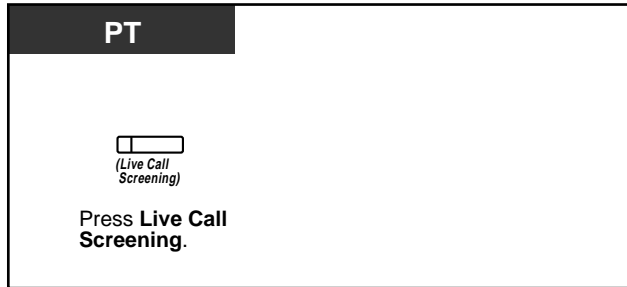

Operation Flowchart

The operations in the shaded areas can be hands-free operations.

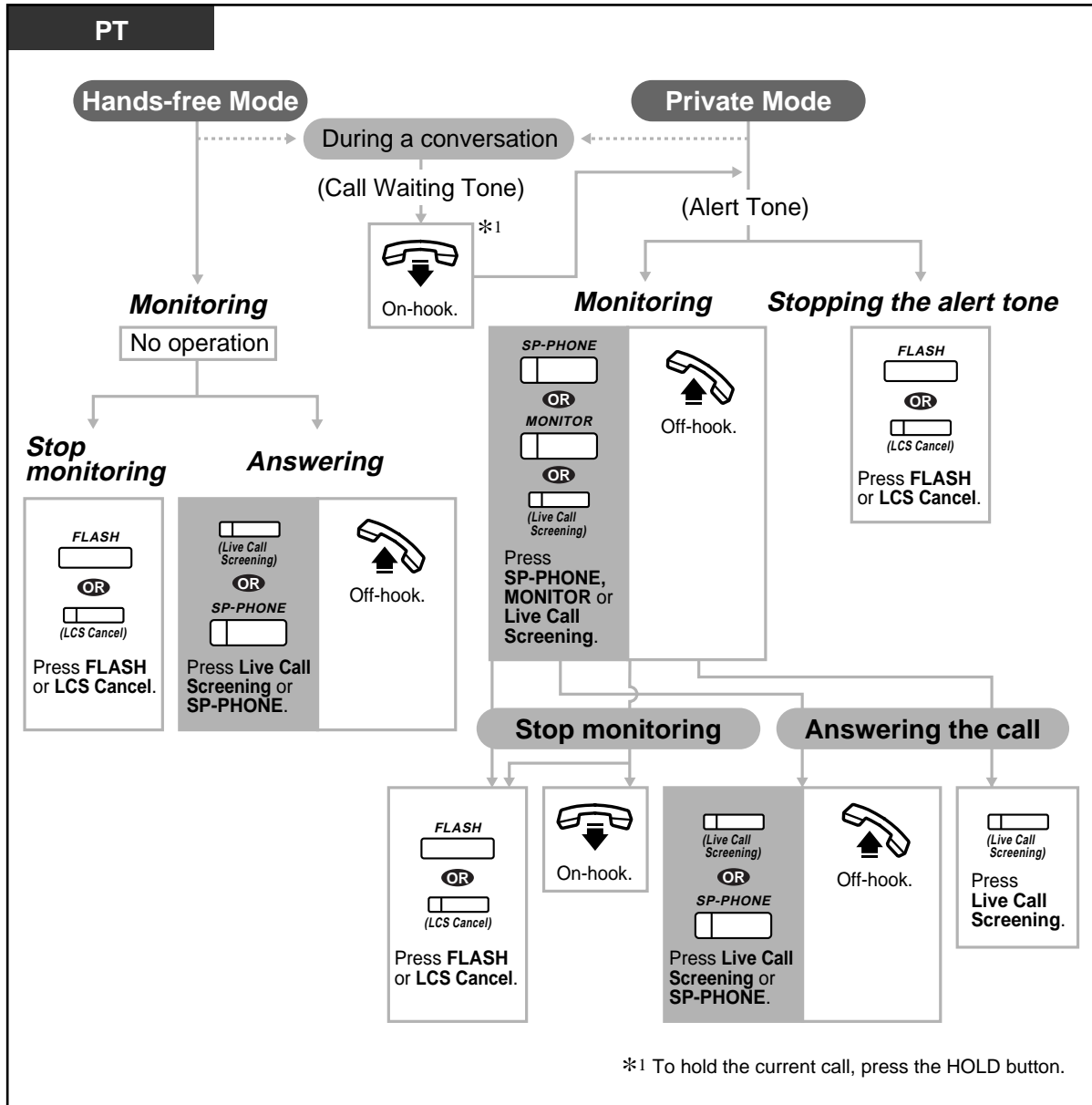

- The Live Call Screening (LCS) button light shows the feature status as follows:
 - Red on:** LCS is on.
 - Off:** LCS is off.
 - Flashing green rapidly:** Alert ringing in the Private mode*2
 - Flashing green slowly:** Live Call Screening is in use.*2
- *2 The DSS button light is red while Live Call Screening is in use.
- The operator can clear a password at any extension.



Customising Your Phone

- 4.1.2 Initial Settings—**Live Call Screening Mode Set**
Select the mode, either monitoring the message automatically or receiving alert ringing, when the caller leaves a message.
- 4.1.3 Customising the Buttons
Create or re-arrange a Live Call Screening button and a Live Call Screening Cancel button.

◆◆ Recording a conversation (Two-Way Recording)

You can record a conversation into a mailbox while talking on the phone.



◆ To record into your mailbox

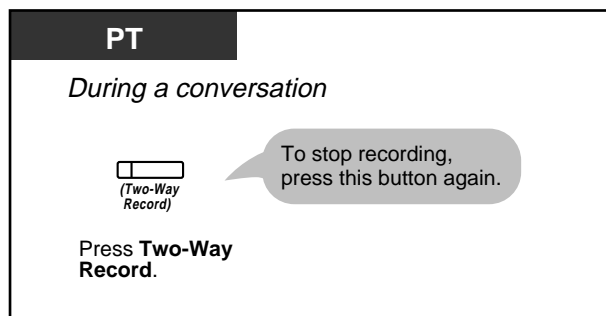

◆ To record into another mailbox

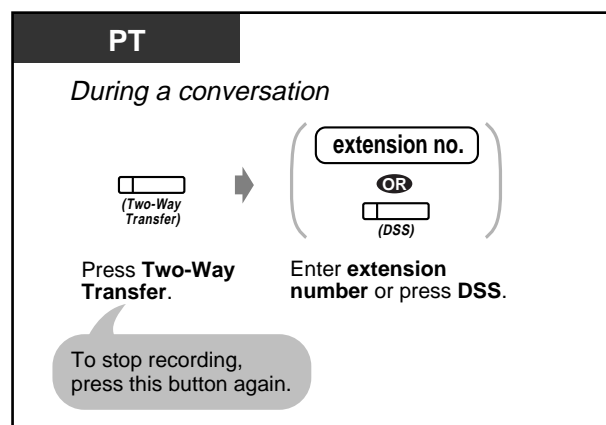

- The Two-Way Record button light shows the current status as follows:

On: Recording the conversation.
Off: Not recording.



- When you record Two-Way telephone conversations, you should inform the other party that the conversation is being recorded.



Customising Your Phone

- 4.1.3 Customising the Buttons
Create or re-arrange a Two-Way Record button and a Two-Way Transfer button.

2.9 Using the Display Proprietary Telephone

2.9.1 Calling Using the Call Log (Incoming Call Log) [KX-T7433, KX-T7436, KX-T7230, KX-T7235 only]

If you do not answer an outside call, the caller's information is recorded automatically in the call log. When the SHIFT button light turns on, there is a call in the call log. You can also store a call log during a conversation. (See "2.9.2 Recording a Call Log [KX-T7433, KX-T7436, KX-T7230, KX-T7235 only].") Up to 15 calls can be logged per extension. You can select how the 16th call is treated; either a new call can be disregarded or a new call overwrites the oldest call. (Default: Overwrite) You can modify and call back the logged numbers.

◆ To confirm

D-PT

While on-hook

OLD

OR

NEW

Press "OLD" or "NEW."

<Information sample>

CO02:Panasonic	-----	Outside line no. & name
012345678	-----	Phone no.
Nina Thomas	-----	Caller's name
22 09:00PM	-----	Receipt date & time
SEQ01 2Call	-----	Sequence no. & calling time (max. 15)
MENU CLR NEXT		

OLD: Information you have already confirmed.
NEW: Information you have not yet confirmed.



- With the KX-T7433 and the KX-T7230, press the INFO button to scroll through information.

Sequence number
and a name

→ Sequence number,
date, time and number
of times called

→ Outside line number
and outside line name



- To modify the phone no, press the "*" key to erase and then enter the number. The number is modified from the first digit. The new number is programmed.
- To return to the initial display, press MENU button or go off-hook and on-hook.

◆ To clear the log

D-PT

CLR

Press "CLR."

◆ **To call back**

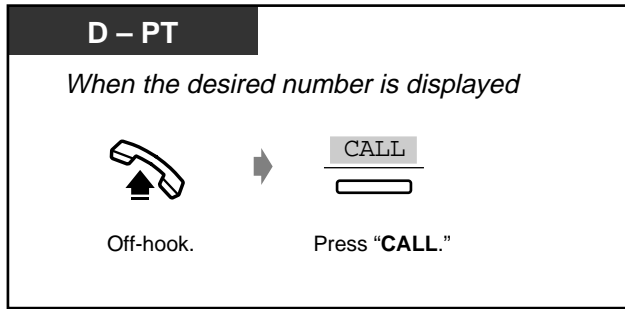

◆ **How to treat the 16th call**

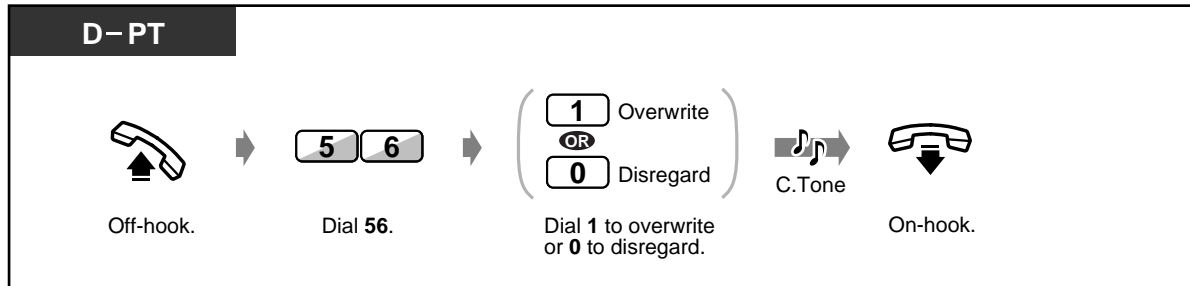

2.9.2 Recording a Call Log [KX-T7433, KX-T7436, KX-T7230, KX-T7235 only]

You can record the caller's information in the call log to call them back. If you do not answer the call, the log is recorded automatically. You can see the call duration during the conversation.

◆ To record a call log

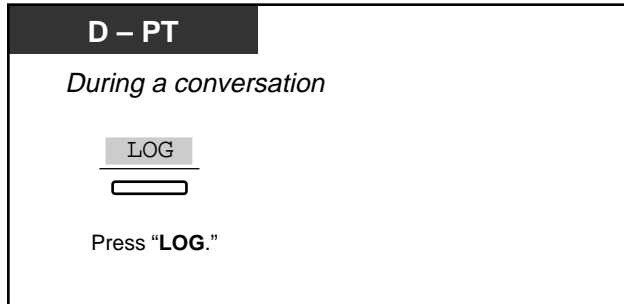

2.9.3 Denying Other People the Possibility of Seeing Your Call Log (Incoming Call Log Lock) [KX-T7433, KX-T7436, KX-T7230, KX-T7235 only]

◆ To lock / unlock

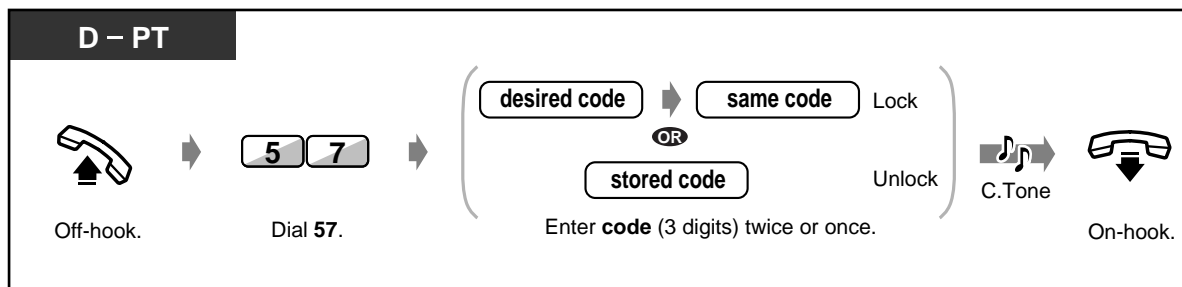

- **If you forget the code**, consult your operator. They can unlock the call log display of any extension (Incoming Call Log Lock Control).

2.9.4 Using the KX-T7433, KX-T7436 or KX-T7235

- Using the KX-T7433
- Using the KX-T7436
- Using the KX-T7235
- Storing the names and numbers for station speed dialling
- Display feature list

◆◆ Using the KX-T7433

A KX-T7433 Panasonic proprietary telephone with a 3-line display allows you to make calls and operate the features using the display message. You do not have to memorise the phone numbers or feature numbers.

Operation

1. Press the SHIFT button repeatedly to show the third display.
2. Press the desired button, if required.
3. Rotate the Jog Dial until the desired message is at the arrow.
(Refer to "Display feature list" in 2.9.4 Using the KX-T7433, KX-T7436 or KX-T7235 for the feature messages.)
4. Press the CALL button or go off-hook to call the party or the SEL button to select the desired feature.
5. Enter parameters if required.

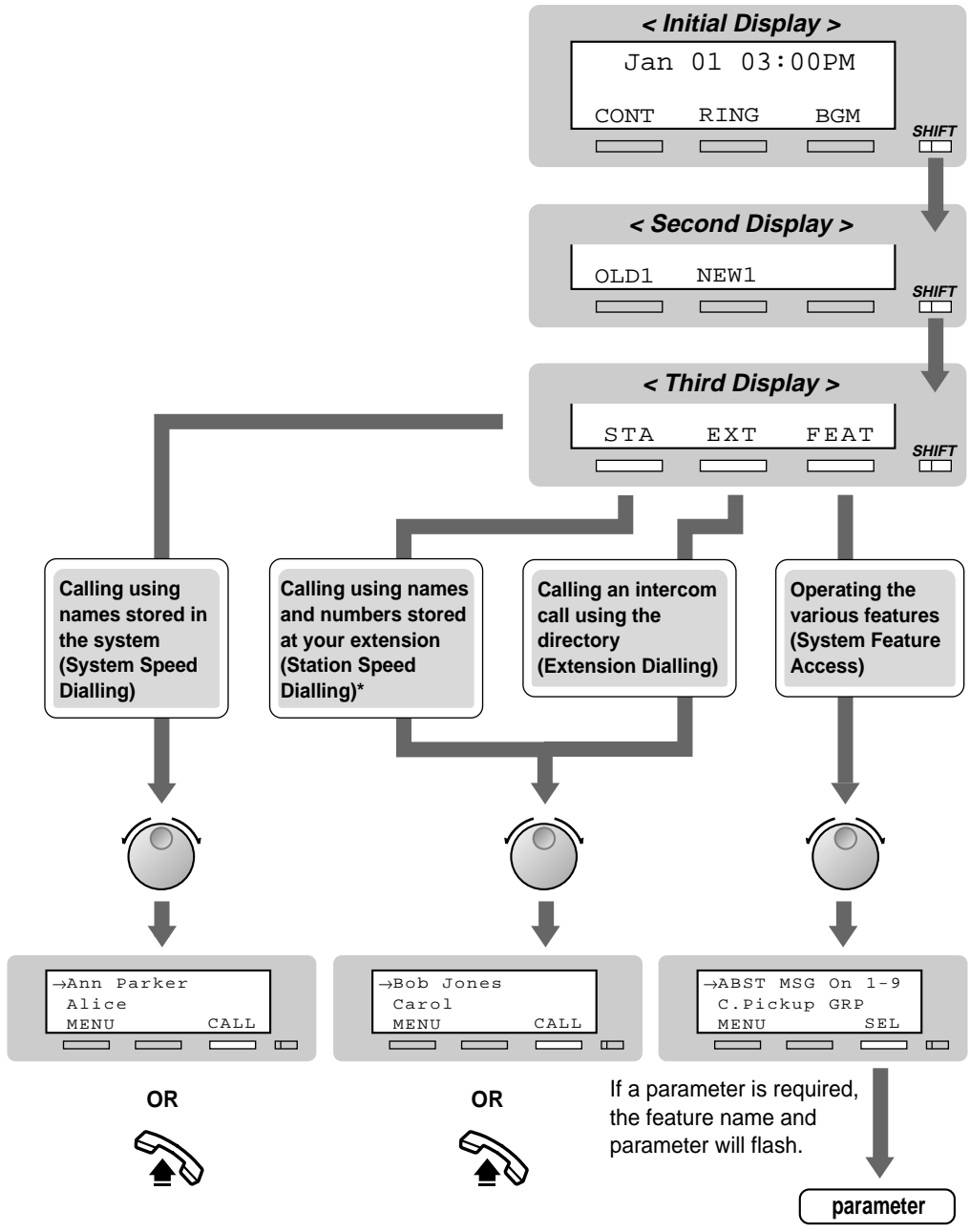

* The names and phone numbers should be stored beforehand. Refer to "Storing the names and numbers for station speed dialling" in 2.9.4 Using the KX-T7433, KX-T7436 or KX-T7235.

◆◆ Using the KX-T7436

A KX-T7436 Panasonic proprietary telephone with a 6-line display allows you to make calls and operate the features using the display message. You do not have to memorise the phone numbers or feature numbers.

Operation using the function buttons

1. Press the desired function button on the initial display.
2. Rotate the Jog Dial until the desired message is at the arrow. (Refer to "Display feature list" in 2.9.4 Using the KX-T7433, KX-T7436 or KX-T7235 for the feature messages.)
3. Press the CALL button, the function button or go off-hook to call the party. Or press the SEL button to select the desired feature at the arrow or press the function button next to the desired feature.
4. Enter parameters if required.

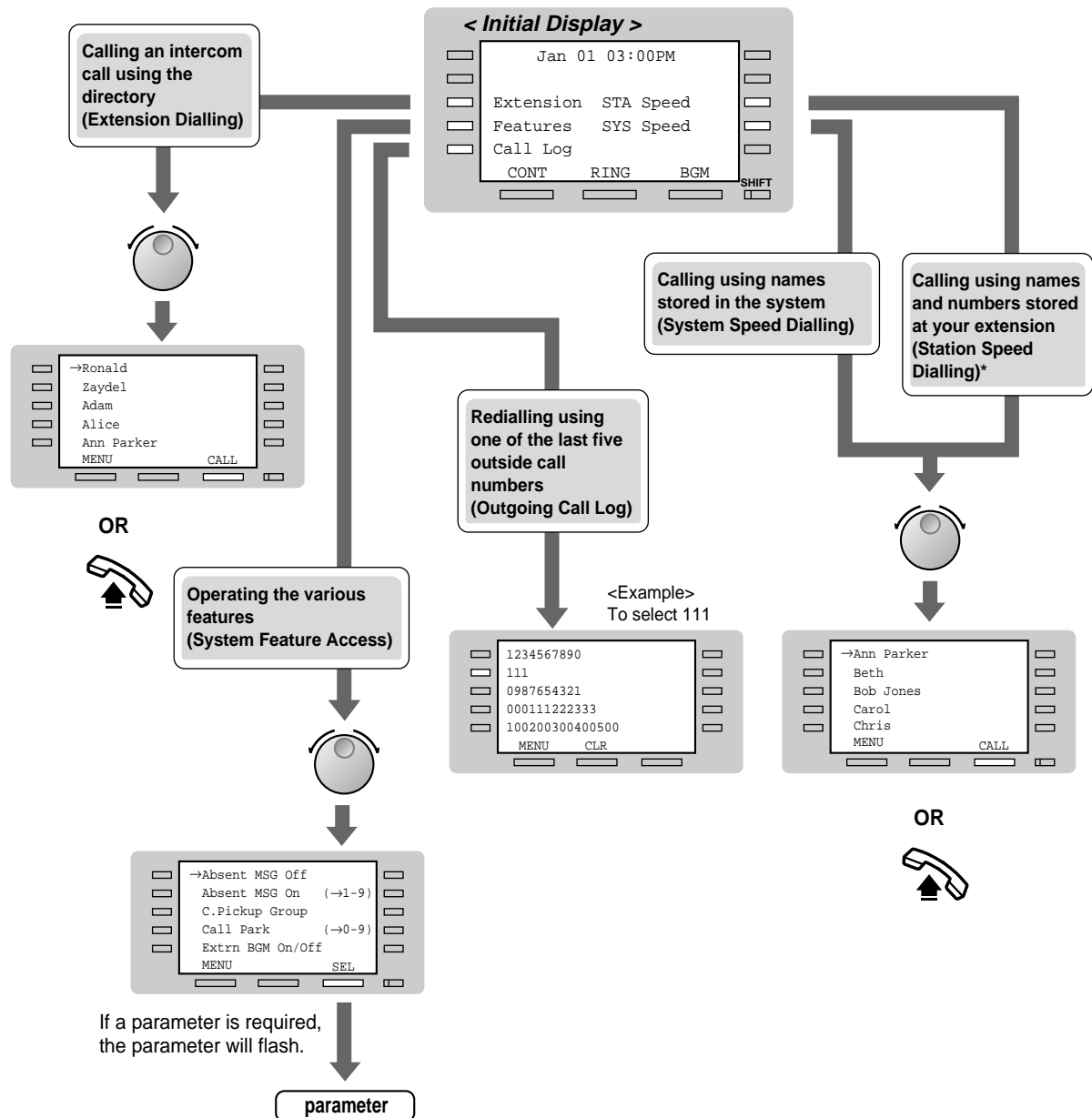



* The names and phone numbers should be stored beforehand. Refer to "Storing the names and numbers for station speed dialling" in 2.9.4 Using the KX-T7433, KX-T7436 or KX-T7235.

Operation using the soft buttons

1. Press the SHIFT button repeatedly to show the third display.
2. Press the desired button, if required.
3. Rotate the Jog Dial until the desired message is at the arrow.
(Refer to "Display feature list" in 2.9.4 Using the KX-T7433, KX-T7436 or KX-T7235 for the feature messages.)
4. Press the CALL button or go off-hook to call the party or the SEL button to select the desired feature.
5. Enter parameters if required.

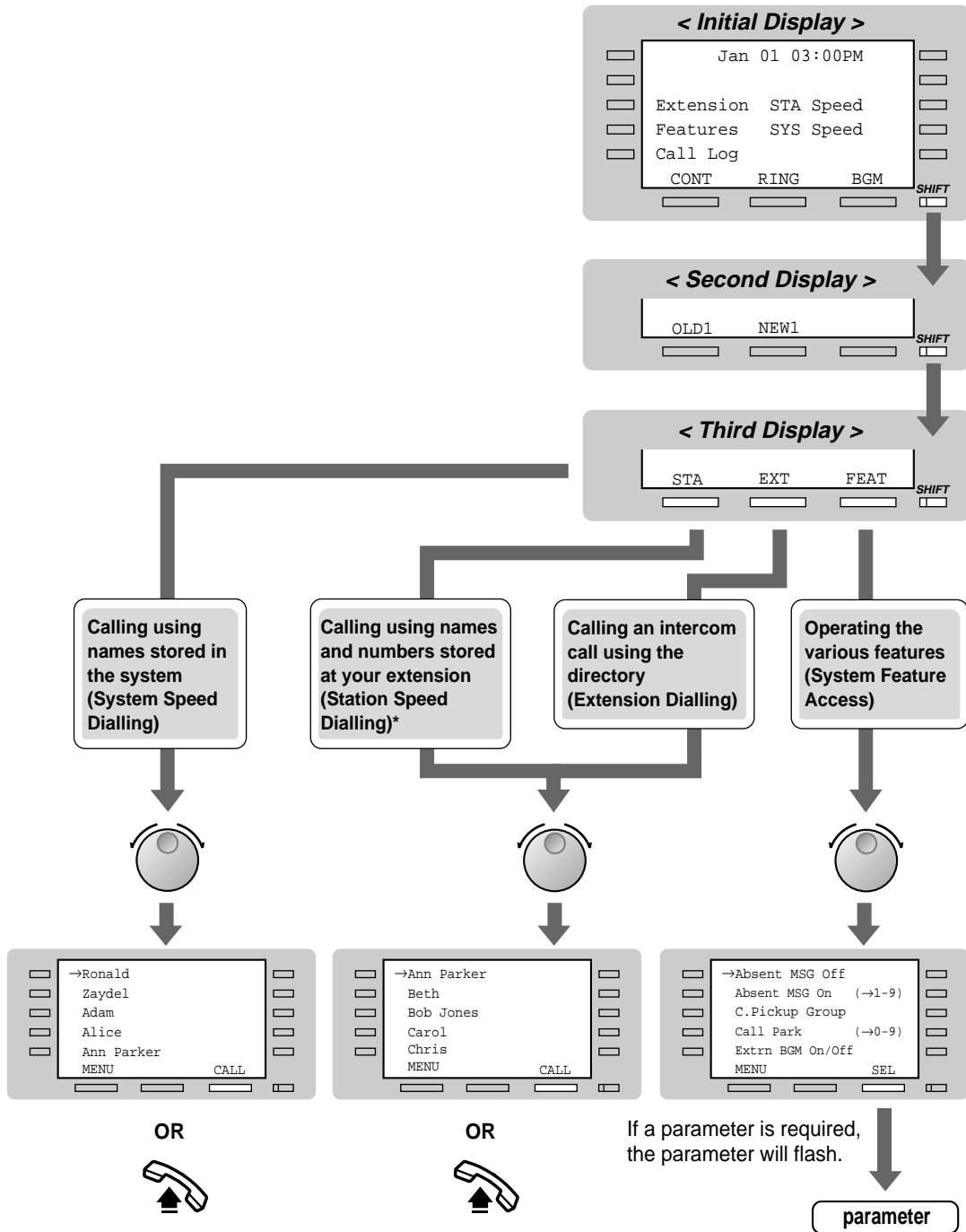

* The names and phone numbers should be stored beforehand. Refer to "Storing the names and numbers for station speed dialling" in 2.9.4 Using the KX-T7433, KX-T7436 or KX-T7235.

◆◆ **Using the KX-T7235**

A KX-T7235 Panasonic proprietary telephone with a 6-line display allows you to make calls and operate the features using the display message. You do not have to memorise the phone numbers or feature numbers.

Operation

1. Press the desired function button on the initial display.
2. Press the desired function button, NEXT button or VOLUME (UP^/DOWNV) Control button until the desired message is displayed.
(Refer to "Display feature list" in 2.9.4 Using the KX-T7433, KX-T7436 or KX-T7235 for the feature messages.)
3. Press the function button next to the desired party or the feature.
4. Enter parameters if required.

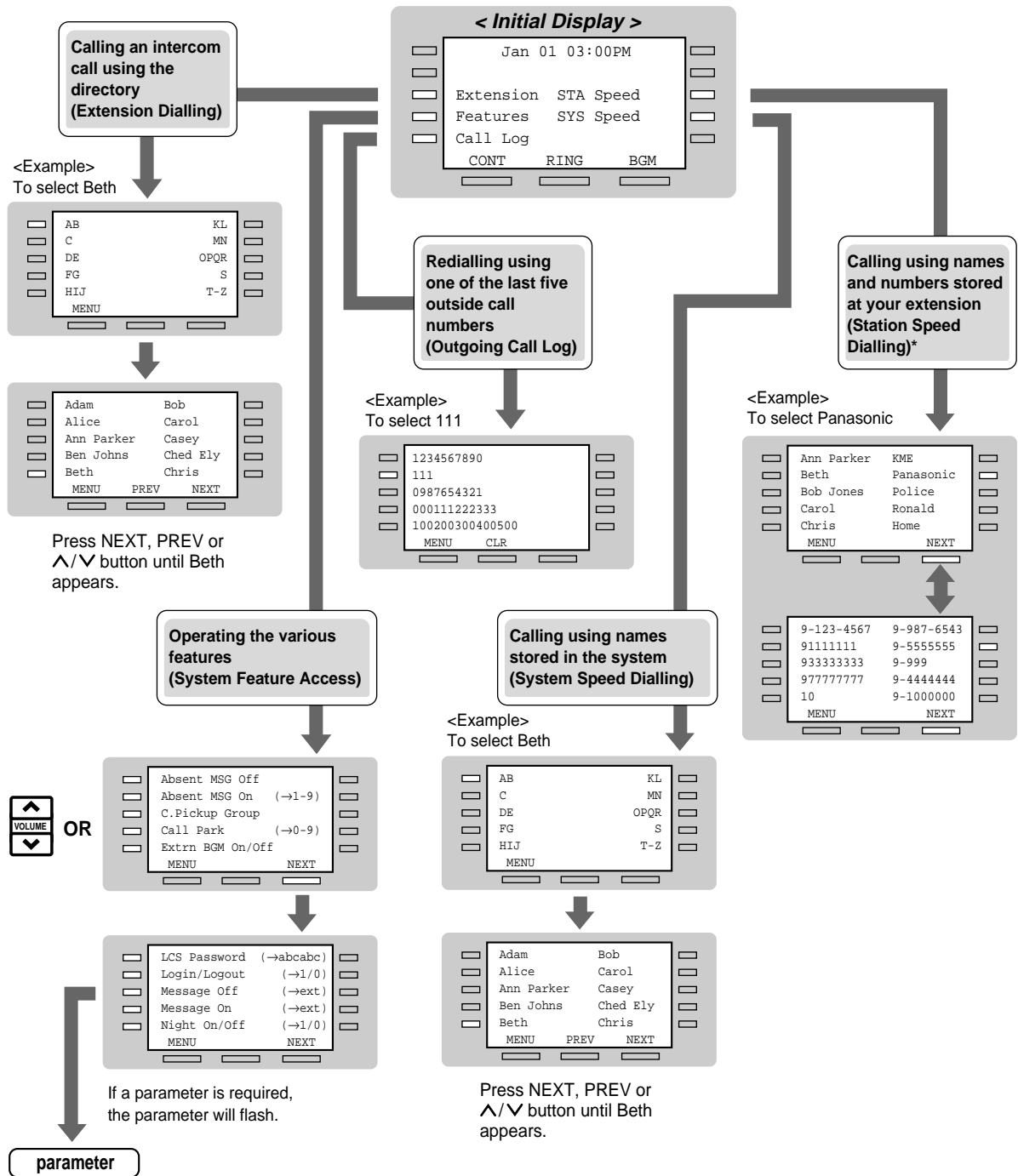

* The names and phone numbers should be stored beforehand. Refer to "Storing the names and numbers for station speed dialing" in 2.9.4 Using the KX-T7433, KX-T7436 or KX-T7235.

◆◆ Storing the names and numbers for station speed dialling

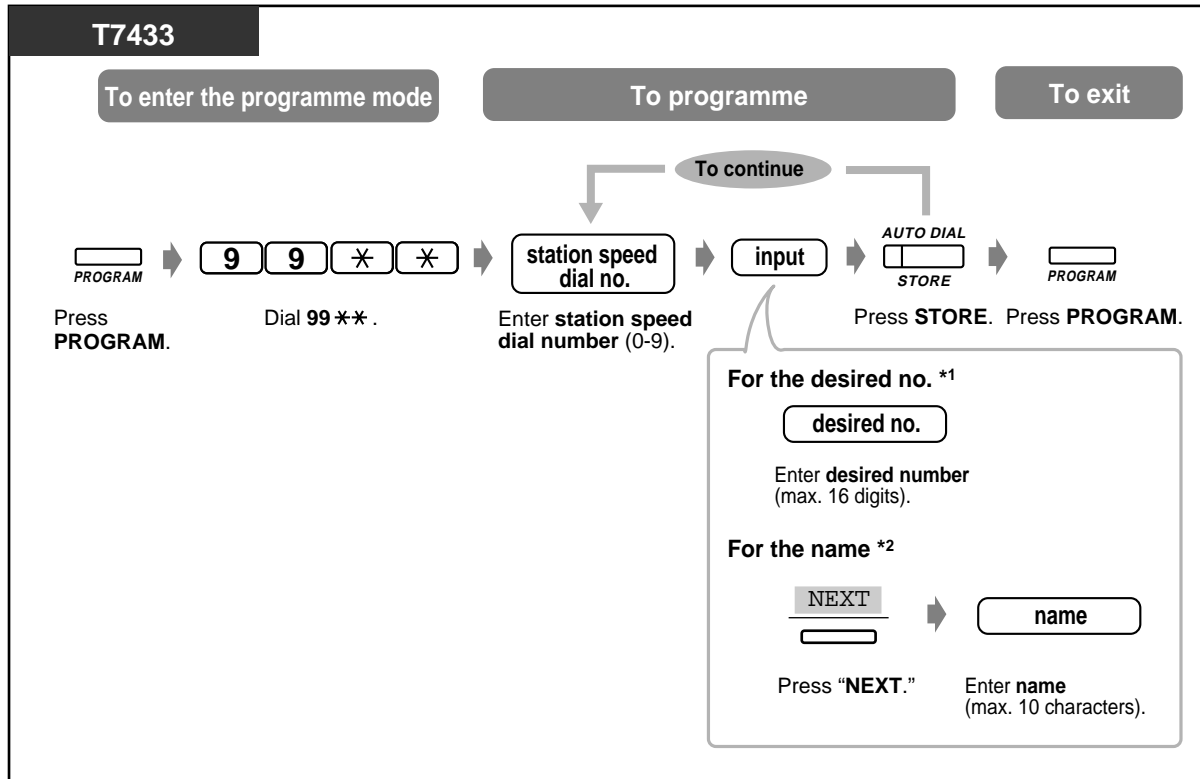

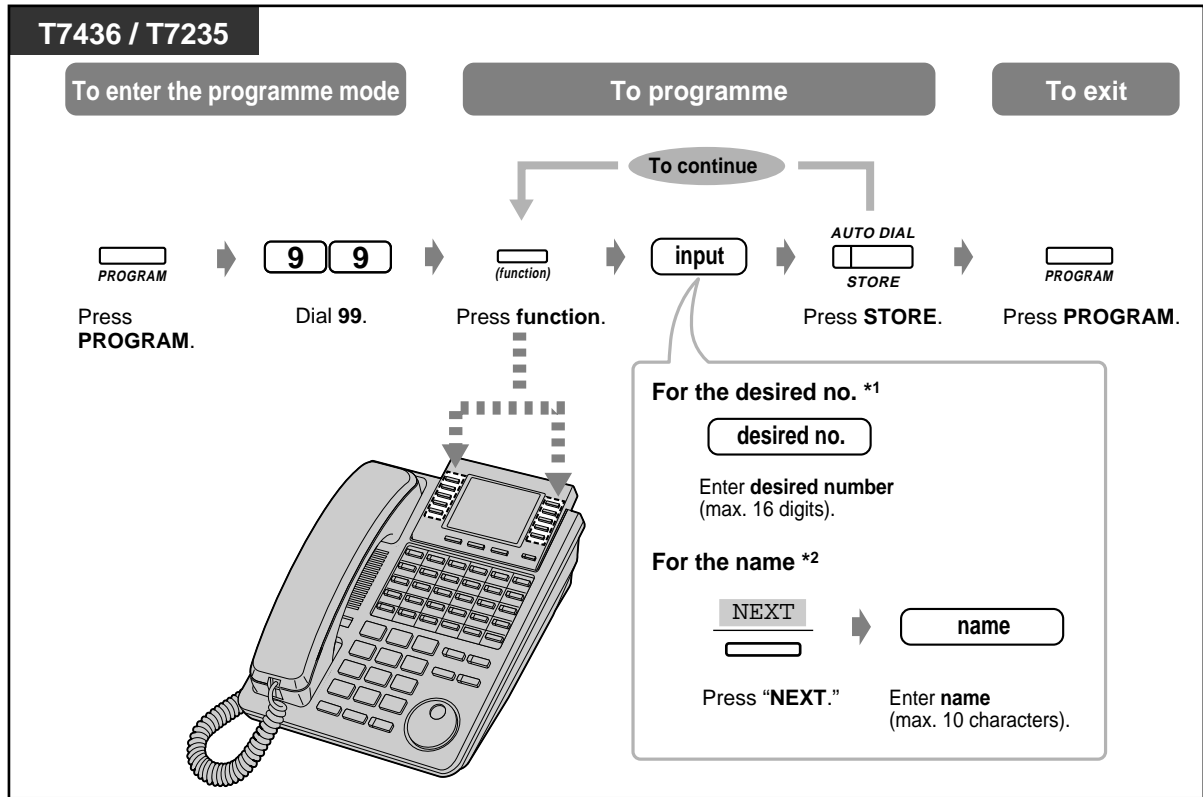

- *1 "×", "#", FLASH, PAUSE, SECRET (INTERCOM) and — (CONF) can also be stored.
- *2 To enter characters, refer to "Character Entry" in 2.9.4 Using the KX-T7433, KX-T7436 or KX-T7235.

◆◆ **Display feature list**

You can access the following features. These displays can be shown by rotating the Jog Dial or pressing the NEXT or PREV button after selecting "Features." For their operation, see the respective operating instructions in the list below.

Display (KX-T7436/KX-T7235)	Display (KX-T7433)	Feature Description
Absent MSG Off	ABST MSG Off	Cancel the absent message. Refer to 2.5.2 Showing an Absent Message on the Caller's Telephone Display (Absent Message Capability).
Absent MSG On (→1-9)	ABST MSG On 1-9	Set an absent message. Refer to 2.5.2 Showing an Absent Message on the Caller's Telephone Display (Absent Message Capability).
C.Pickup Group	C.Pickup GRP	Pick up a call within your extension group. Refer to 2.3.3 Answering a Call Ringing at Another Telephone (Call Pickup).

Display (KX-T7436/KX-T7235)	Display (KX-T7433)	Feature Description
Call Park (→0-9)	Call Park 0-9	Place a call on hold in a system parking area. Refer to 2.4.1 Holding a Call.
Extrn BGM On/Off	Ext-BGM On/Off	Turn on/off the background music.* Refer to 3.2.2 Turning on the External Background Music.
LCS Password (→abcabc)	LCS # abcabc	Assign the password for the Live Call Screening feature. Refer to 2.8.3 If a Voice Processing System is Connected.
Login/Logout (→1/0)	Login/out 1/0	Join or leave the call receiving group. Refer to 2.5.4 Leaving a Call Distribution Group (Log-In / Log-Out).
Message Off (→ext)	MSG Off ext	Cancel a notification. Refer to 2.2.4 When the Dialed Line is Busy or There is No Answer.
Message On (→ext)	MSG On ext	Leave a notification so that the called party may call you back. Refer to 2.2.4 When the Dialed Line is Busy or There is No Answer.
Night On/Off (→1/0)	Night Mode 1/0	Change the night service mode; night (On) or day (Off).* Refer to 3.2.1 Day / Night Service.
OGM Playback (→1-4)	OGM Play 1-4	Playback the outgoing message.* Refer to 3.2.3 Recording Outgoing Messages.
OGM Recording (→1-4)	OGM Record 1-4	Record an outgoing message.* Refer to 3.2.3 Recording Outgoing Messages.
Page-Ext Answer (→1-4)	Page-E ANS 1-4	Answer the paged announcement through a speaker. Refer to 2.3.4 Answering a Call via an External Speaker (Trunk Answer From Any Station [TAFAS]) and 2.6.3 Answering a Paged Announcement.
Page-GRP Answer	Page-GRP ANS	Answer the paged announcement through a telephone in the same extension group. Refer to 2.6.3 Answering a Paged Announcement.
Paging External (→0-4)	Page Extrn 0-4	Page through the speaker. Refer to 2.6.1 Paging.

Display (KX-T7436/KX-T7235)	Display (KX-T7433)	Feature Description
Paging Group (→0-8)	Page GRP 0-8	Page to all or a particular extension group. Refer to 2.6.1 Paging.
Parallel On/Off (→1/0)	Parallel 1/0	Set whether a single line telephone connected in parallel will ring (On) or not (Off) when receiving a call. Refer to 2.7.10 Setting the Parallel Connected Telephone Ringer (Paralleled Telephone).



* The message is useful for the operators only.

Call Forwarding/Do Not Disturb feature:

You can also access the Call Forwarding and Do Not Disturb features. Go off-hook and press the FWD/DND button. You will see the following displays. For their operation, see the respective operating instructions. The KX-T7436 and the KX-T7235 users only use this display operation.

FWD/DND Cancel	
Do Not Disturb	
FWD-All Calls	0-2+ext
FWD-Busy	0-2+ext
FWD-No Answer	0-2+ext
MENU	PREV NEXT

FWD-BSY/NA	0-2+ext
FWD-CO Line	0-2+dial
FWD-From	ext
FWD-From Cancel	ext
MENU	PREV NEXT

Section 3

Operator Operation

This chapter shows the operators how to control the extensions or the system. Your system supports up to two operators. Your system supports up to two operators.

3.1 Extension Control

3.1.1 Changing the Settings

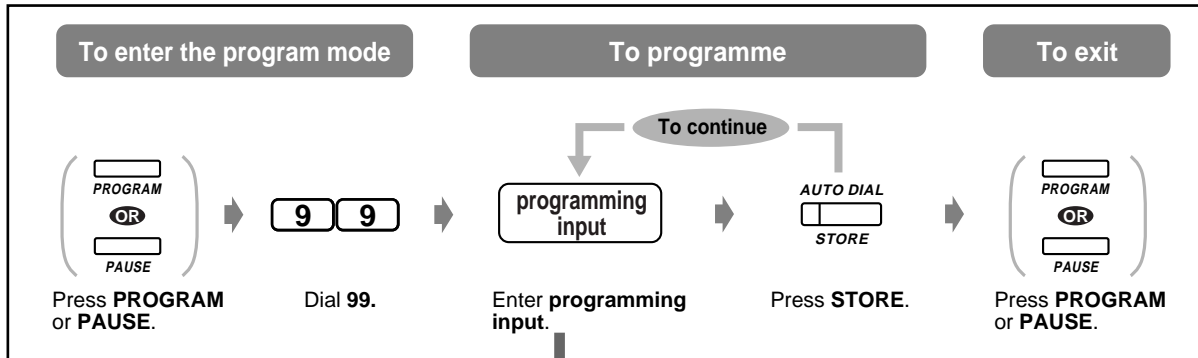

Item	Programming Input
Unlocking or locking any extension (Remote Station Lock Control)	0 1 extension no.* X X=1 : Unlock 2 : Lock outside calls 3 : Lock intercom calls except operator call
Unlocking the call log (Incoming Call Log Lock Control)	7 extension no.*
Clearing the Live Call Screening Password (Live Call Screening Password Control)	0 3 extension no.*



* To assign all extensions, press the "*" key.

3.2 System Control

3.2.1 Day / Night Service

You can change the Day/Night mode at any time.

PT



Press **Night**.

PT / SLT

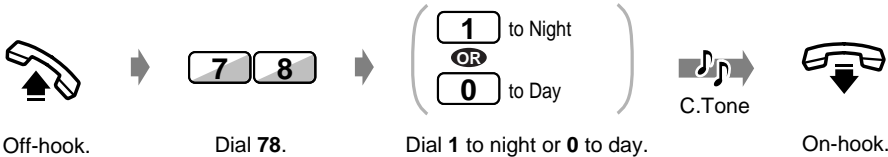

Off-hook. Dial **78**. Dial **1** to night or **0** to day. C.Tone On-hook.

T7433

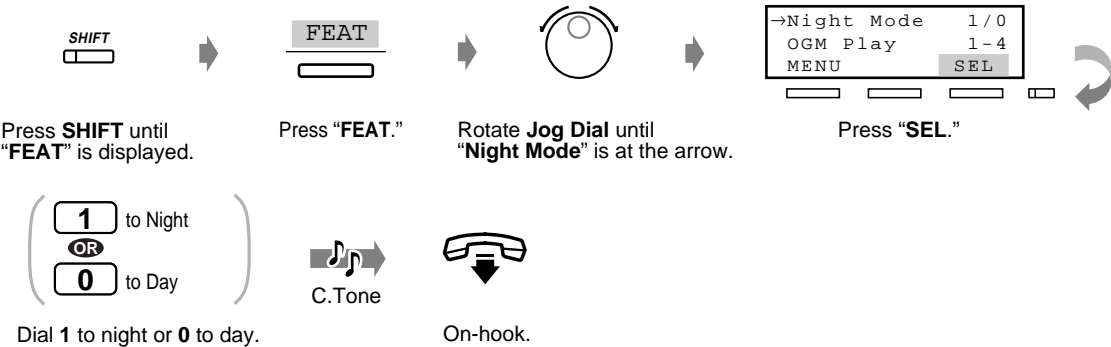

Press **SHIFT** until "FEAT" is displayed. Press "FEAT."

Rotate **Jog Dial** until "Night Mode" is at the arrow.

Press "SEL."

Dial **1** to Night or **0** to Day. C.Tone On-hook.

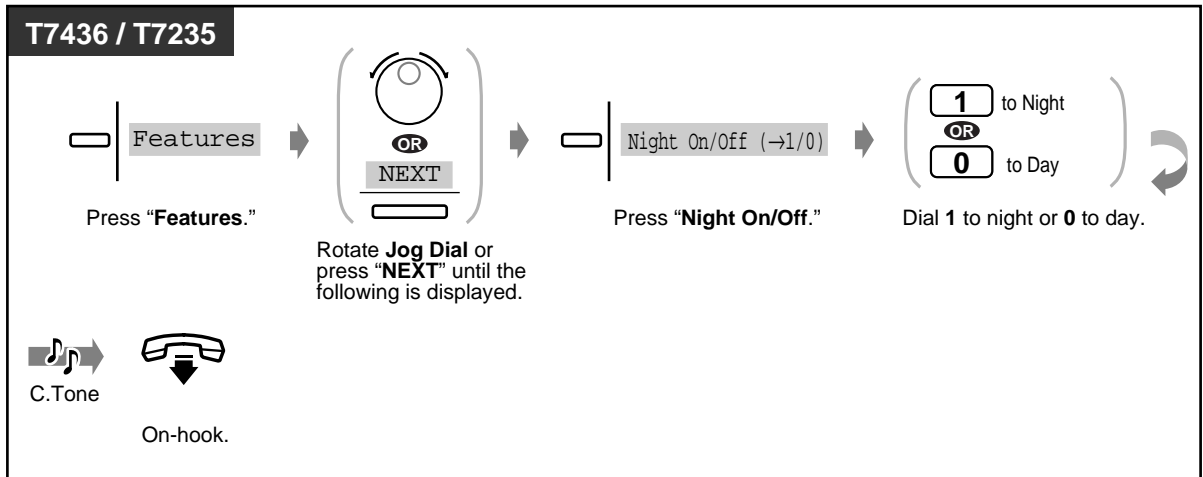

- The Night button alternates the setting between Day and Night modes.
- **To confirm the current mode**, press the "#" key while on-hook.
- The Night button light shows the current status as follows:
 - Off:** Day mode
 - Red:** Night mode

Customising Your Phone

- 4.1.3 Customising the Buttons
Create or re-arrange a Night button.

3.2.2 Turning on the External Background Music

You can broadcast background music in the office through external speakers.

◆ To start / stop background music

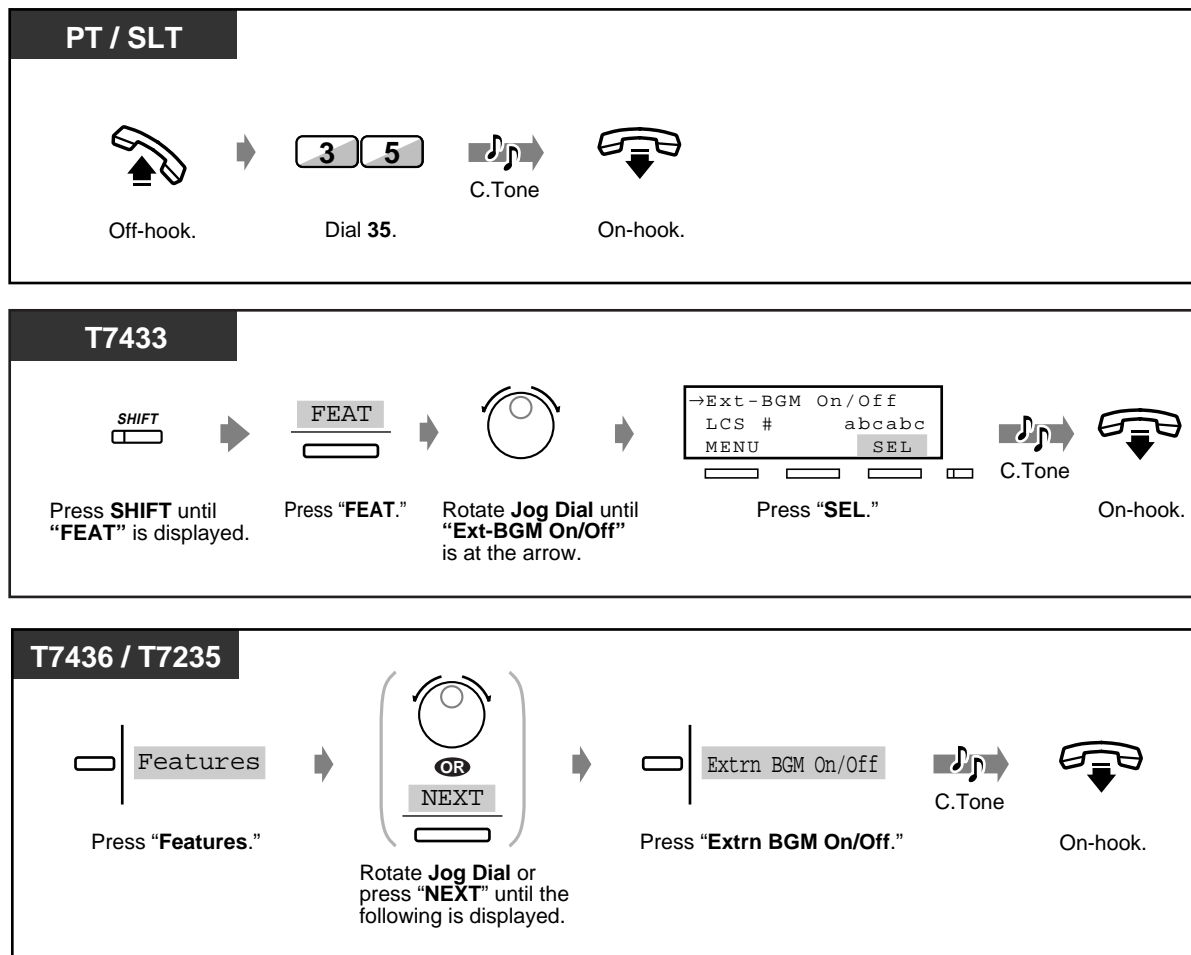

3.2.3 Recording Outgoing Messages

DISA messages (OGM 1 and 2): Used for the greeting message or guidance when an external party calls your company to access an extension or external party without any operator assistance. (Refer to 2.2.8 To Access Another Party Directly from Outside (Direct Inward System Access [DISA]).)

Timed Reminder message (OGM 3): Often used as wake-up call which is played when answering the Timed Reminder alarm.

UCD (receiving group) messages (OGM1-4): Used for the greeting message or guidance when an external party calls your company to access an extension without any operator assistance. Up to four different UCD messages can be recorded.

You can also play back the recorded message for confirmation.

◆ **To record**

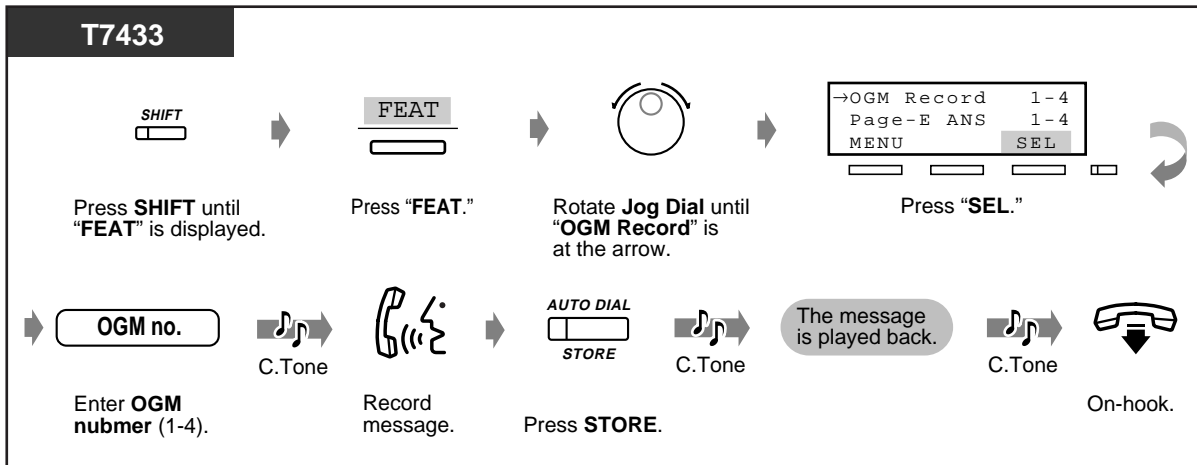
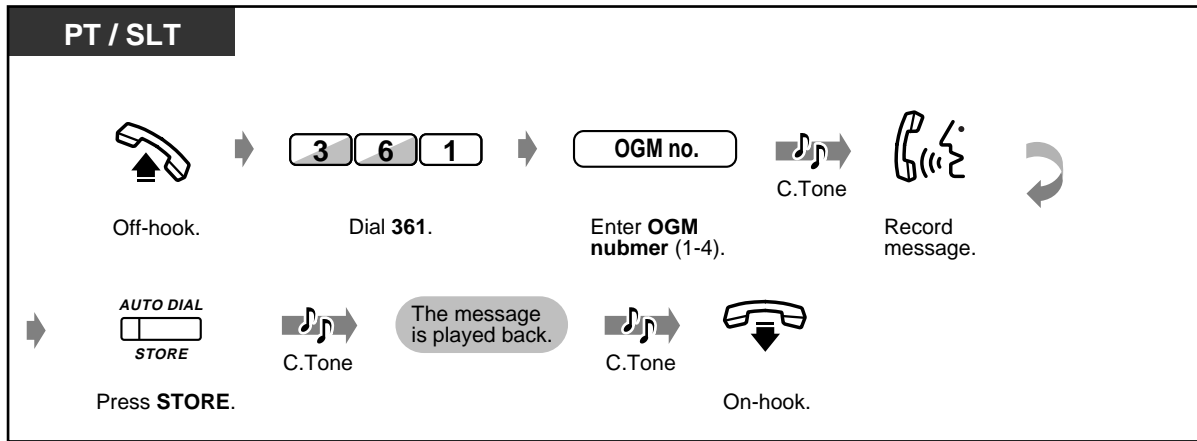

◆ **To record (contd.)**

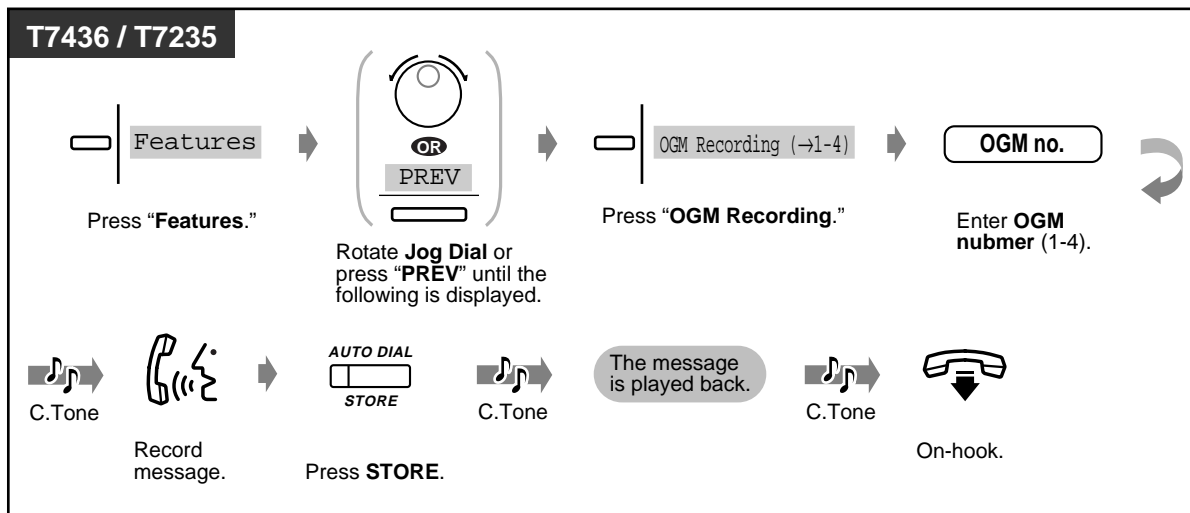

◆ **To play back**

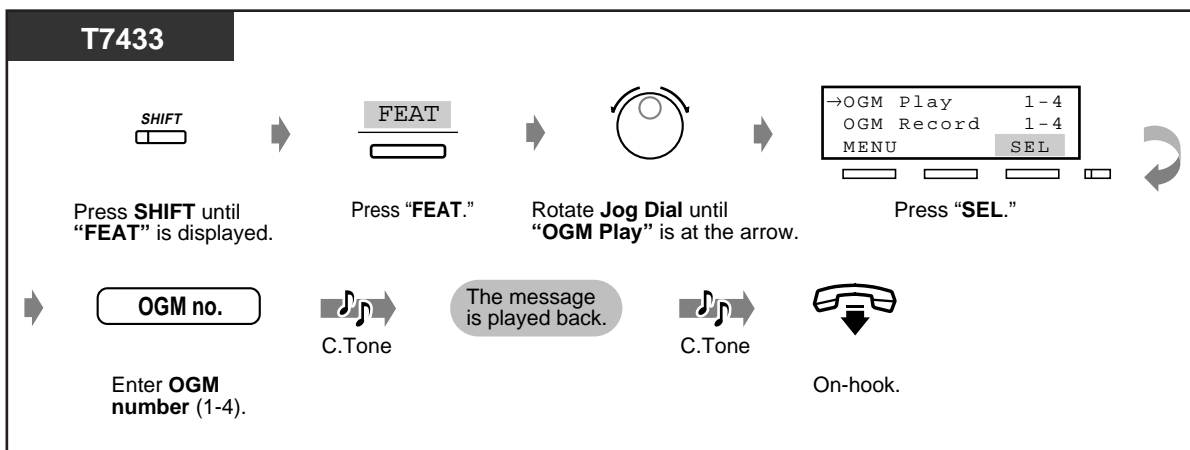
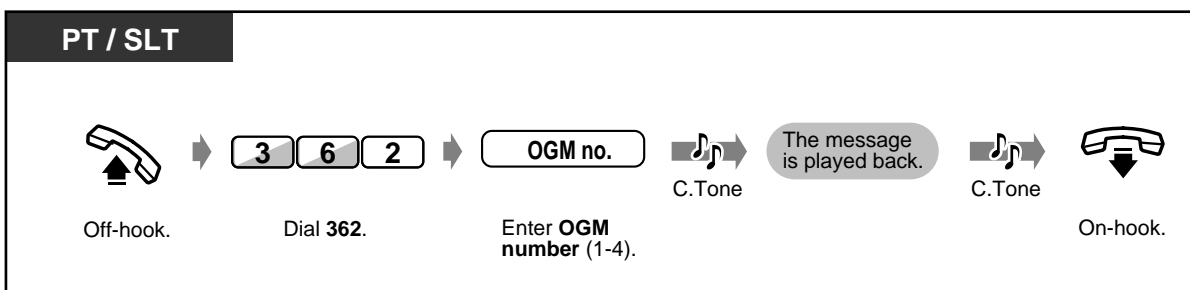

◆ To play back (contd.)

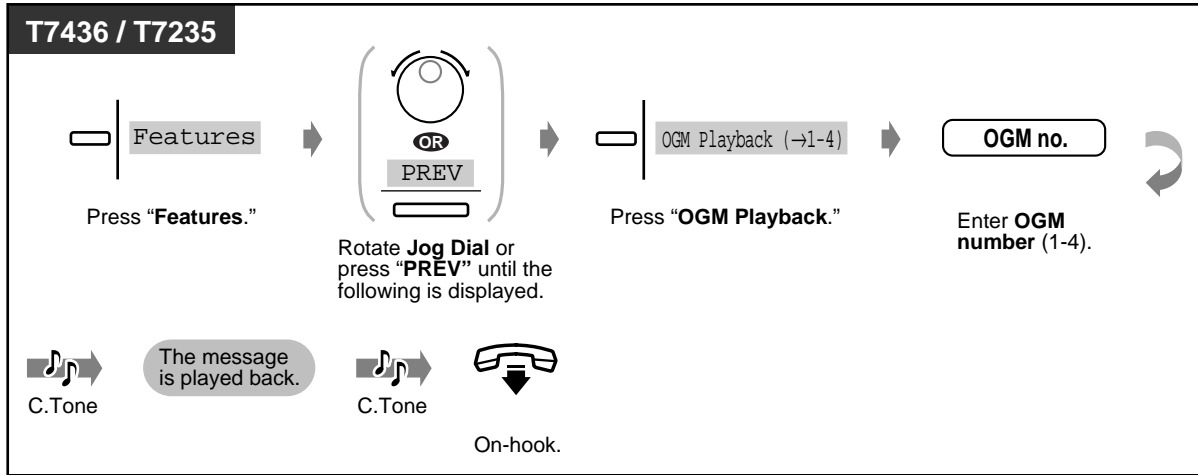

- To stop recording or playing back, press the AUTO DIAL / STORE button.
- **Message recording limit**
The total length must be under sixty four seconds or less. (Default: 32 seconds for OGM 1 and 3 and 0 second for OGM 2 and 4)
- The optional unit or card is necessary to utilise this feature.

3.2.4 Using the ANSWER / RELEASE Button [KX-T7441 only]

The ANSWER and RELEASE buttons on the Console are convenient for operators using headsets. With the ANSWER button, you can answer all incoming calls to the paired telephone. With the RELEASE button, you can disconnect the line during or after a conversation, or complete transferring a call.

◆ To answer

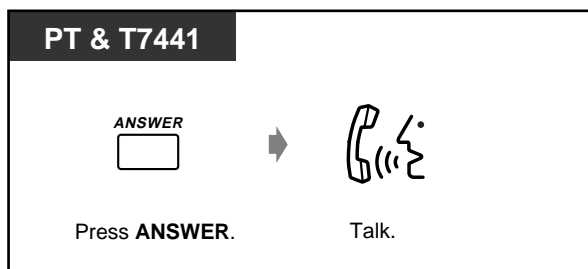

◆ To transfer a call

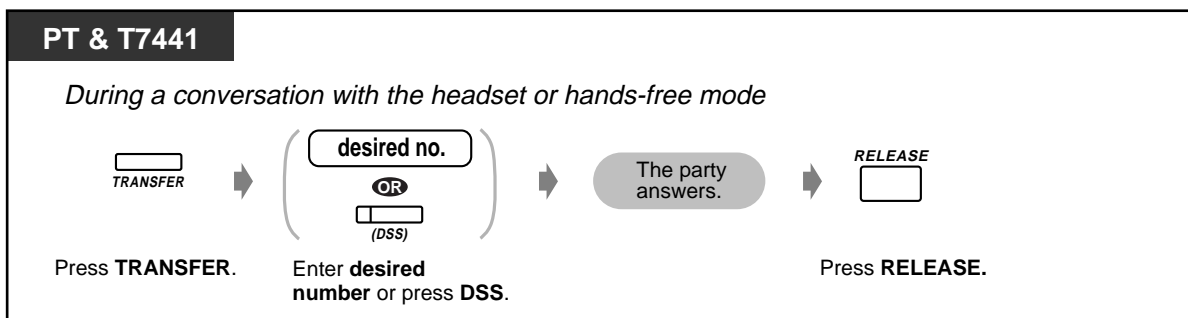

◆ To transfer an outside call to an extension with one-touch

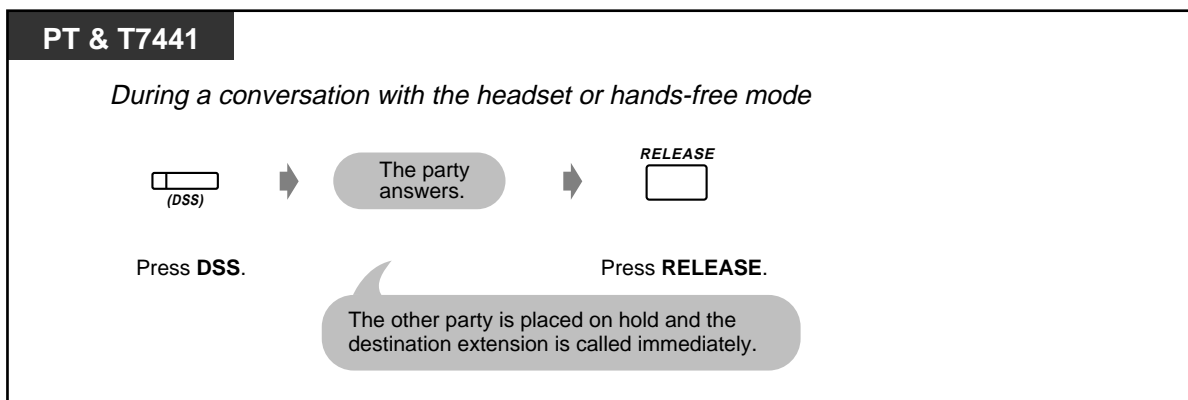

3.2.5 Hotel Use Features [KX-T7436, KX-T7235 only]

- Check-in / check-out
- Setting the alarm for other extensions

◆◆ Check-in / check-out

The check-in mode activates the primary service mode and automatically clears the charge counter. The check-out mode activates the secondary service mode and prints out the charge counter, minibar and other expenses. Changing the room status can be done by the operator and also by the telephone in a guest room.

◆ To check-in

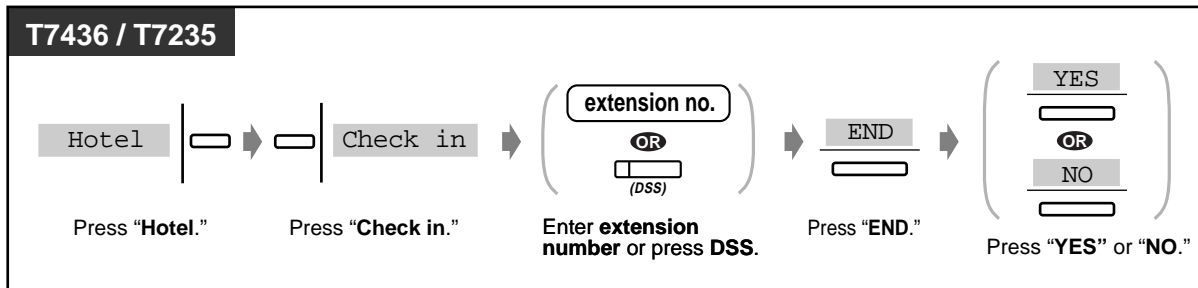

◆ To check-out when the printer is connected

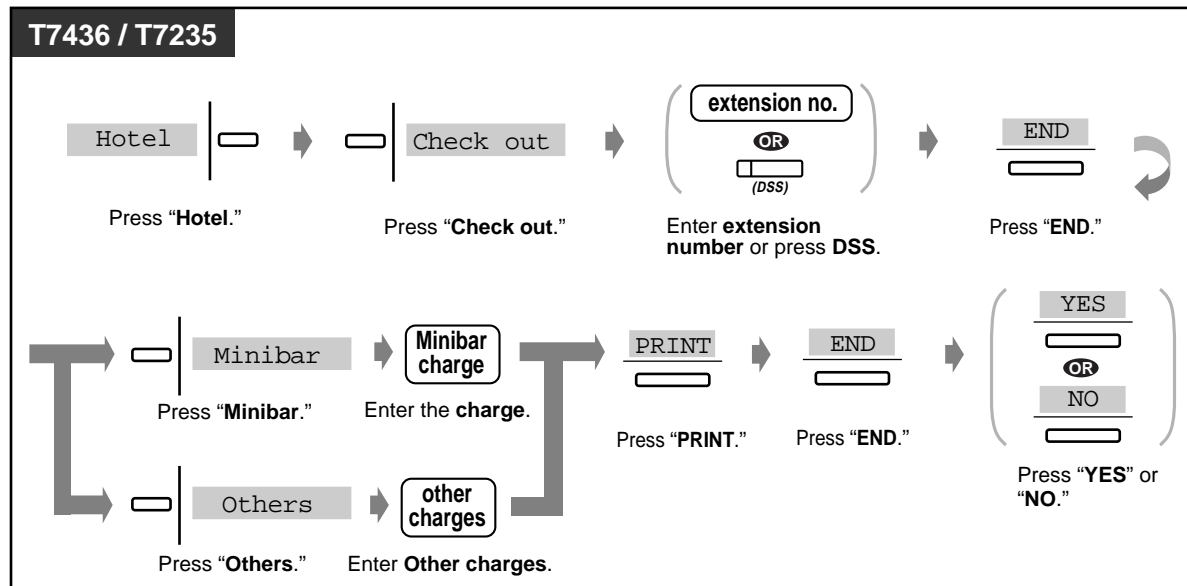

◆ **To check-out when the printer is disconnected while confirming the display**

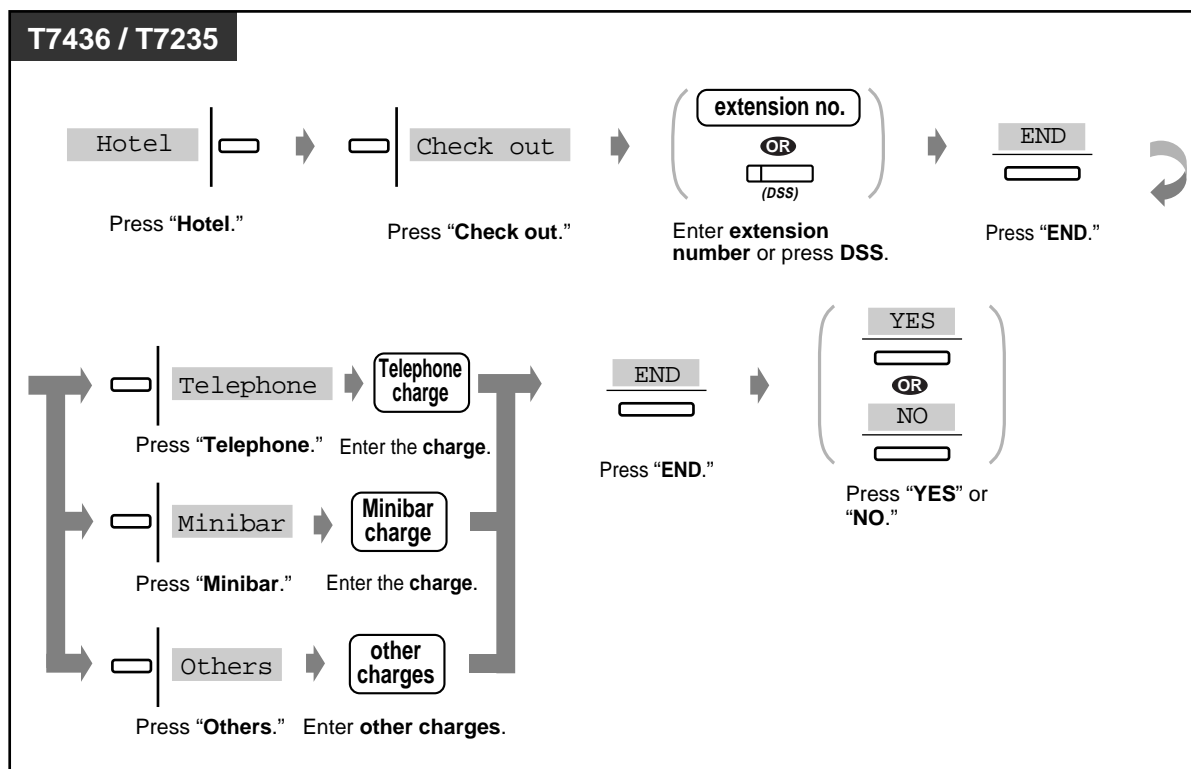

◆ **To change the room status from the operator after check-out**

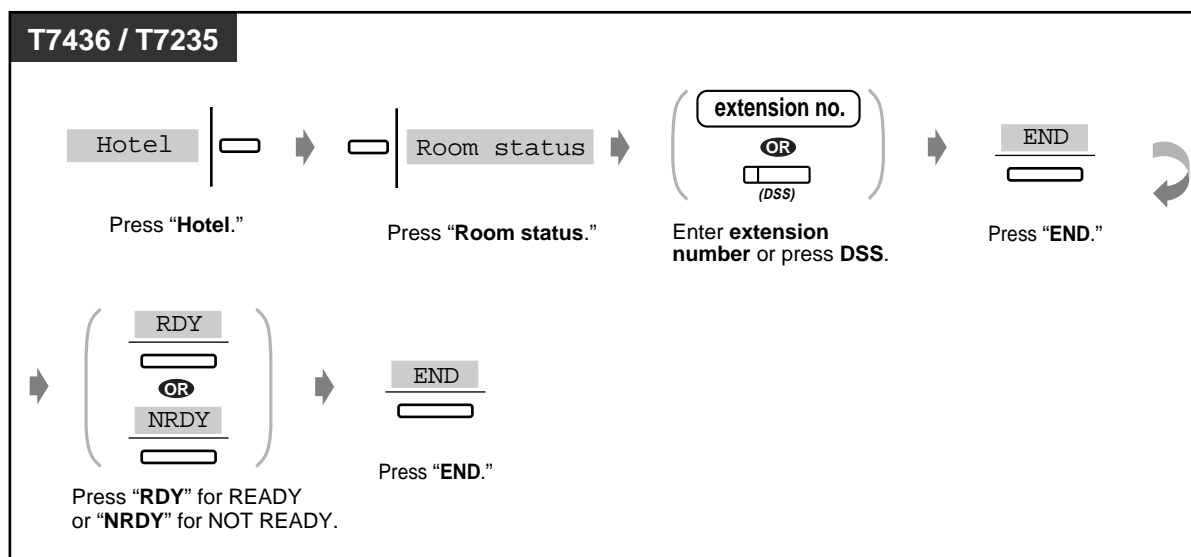

◆ **To change the room status at a telephone in a guest room cleaned up after check-out**

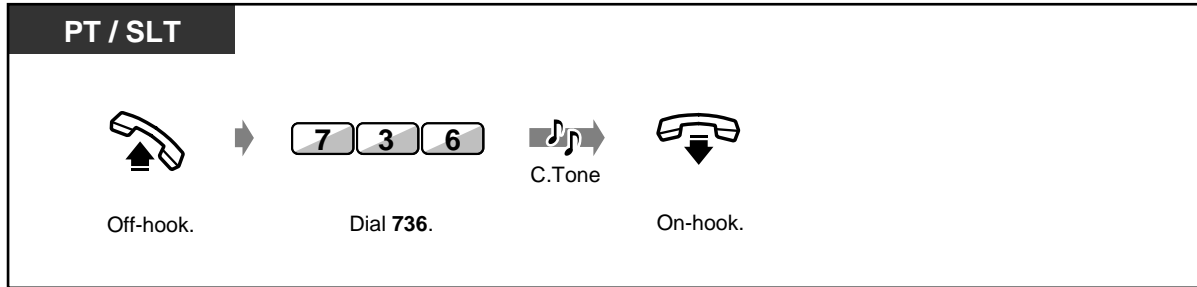

- It is possible to charge the minibar or other expenses or to change the expenses. In this case, enter the revised charge after pressing the appropriate button.
- There are two types of check-out mode, ready or not ready (cleaned up or not).
- The check-out operation by the operator automatically changes the room status from check-in to check-out (not ready) mode.
- There is a check-out information area available for 1000 calls in the system. If over 900 numbers are stored in the area, the information of the extension which is used most is automatically printed out. In this case, to distinguish a regular check-out sheet from an automatic one, "***" is printed after the room number that is automatically printed out.
Ex. [Room : 201 **]
- After 900 calls are stored in the system, the information for the extension with the most calls will be printed out. When printing that extension's regular check-out sheet, the "Call amount" shows the numbers of calls which have been printed out beforehand.
Ex. [01/01/99 12:05 AM 201 Call amount : 25]
- When you use this feature, you must assign the Flow Control of your printer to "XON/XOFF".
- The DSS button light shows the current status as follows:
Red on: Check-in
Off : Check-out (ready)
Flashing red: Check-out (not ready)

Data similar to below is printed out.

* Check Out Sheet *		*****	
Check in : Jan.30.99 17:30			
Check out : Jan.31.99 00:15			
Room : 201			
01/30/99 06:00PM 201 01 4812134	00:00'52	46.23	\$
01/30/99 06:30PM 201 01 4775678	00:00'30	23.00	\$
01/30/99 07:21PM 201 01 4905100	00:00'44	30.77	\$
Telephone	100.00		
Minibar	25.00		
Others	12.50		

Total	\$	137.50	



There are other useful Hotel Features as follows:

- After check-in, a guest can make an outside call.
After check-out, a guest cannot make an outside call.
- When check-out, "Total" includes the telephone margin.
To enter the margin, consult your manager or dealer.
- To inform the message has been left, the Message button light turns on or ringing starts at a single line telephone in a guest room.
If a Voice Processing System is connected, a guest can hear the message which is stored in a mailbox.
- A guest can access the extension simply by pressing one digit number.(e.g. room service)
- An operator can deny making an intercom call from a guest room to prevent a prank call.

◆◆ **Setting the alarm for other extensions (Wake-up Call)**

The operator can remotely set / cancel the alarm for a desired extension. If the Alert button on Operator 1's extension turns red, it indicates that a guest has not responded to the wake-up call.

◆ **To set**

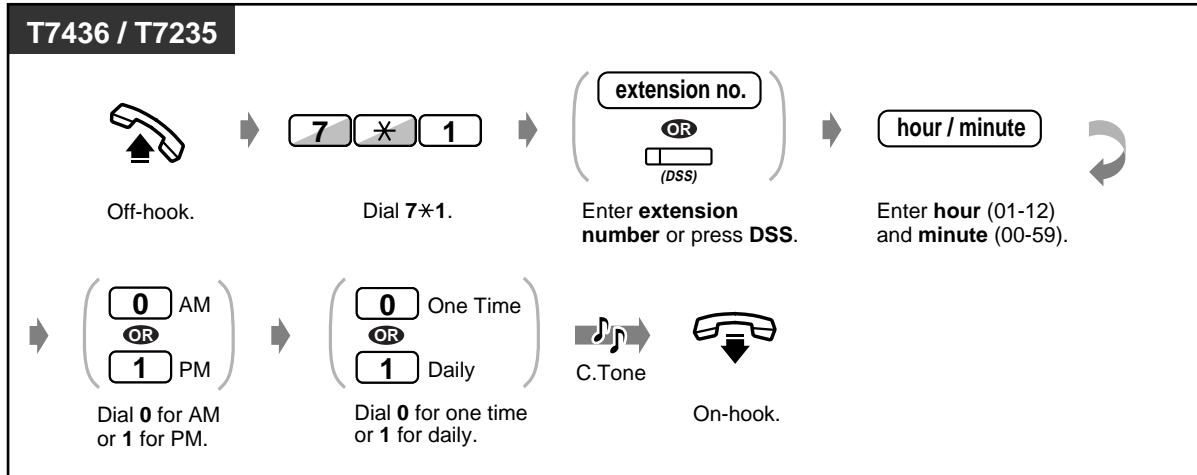

◆ **To cancel**

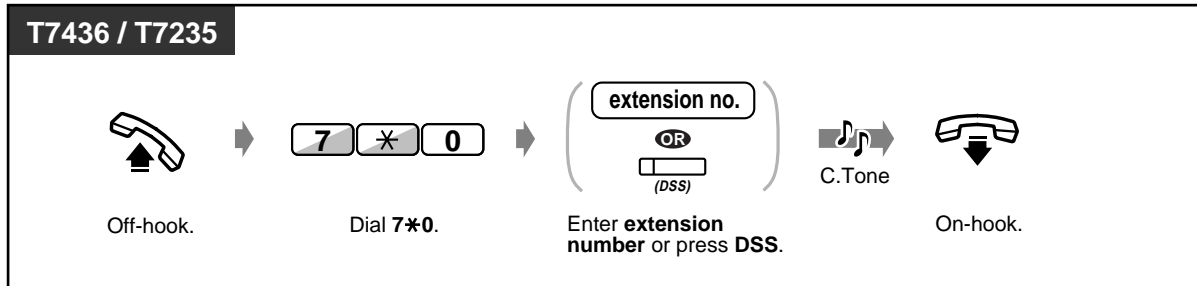

◆ **To view the setting**

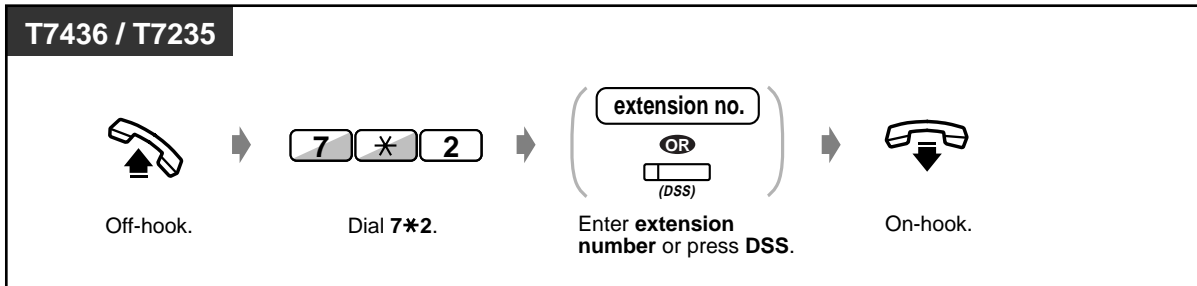

◆ **To confirm the room number unanswered timed reminder alert**

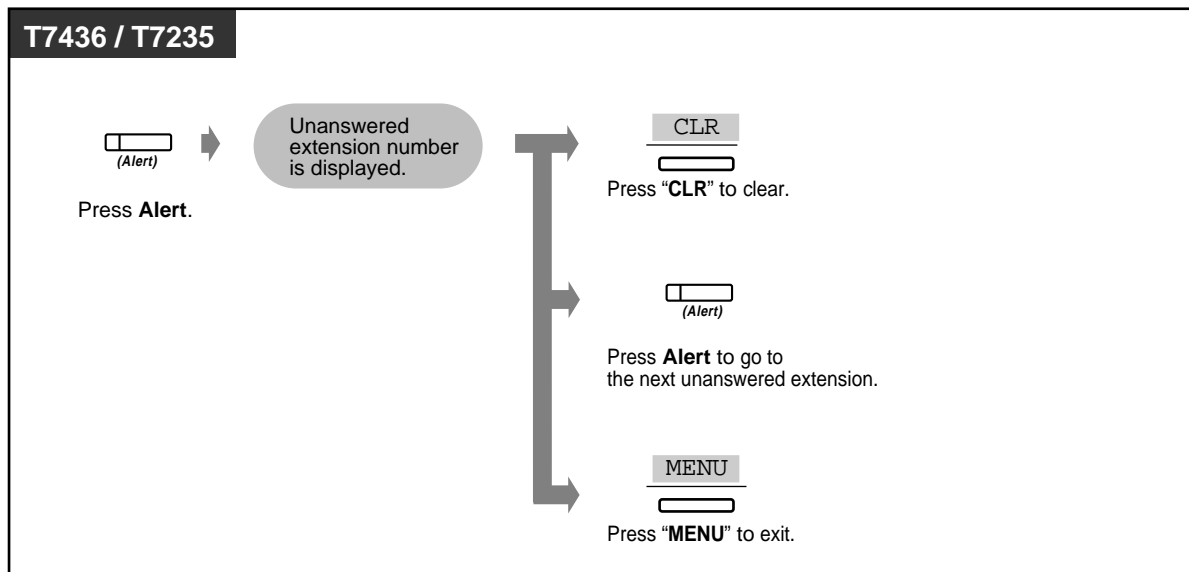

◆ **To call back the unanswered room**



- A voice message can be recorded by the operator if required. (Refer to 3.2.3 Recording Outgoing Messages.)
- The alarm rings three times (30 seconds each) in a sixty seconds interval (Default).
- An Alert button can be assigned on the operator 1's telephone only.
- The detailed timed reminder information is recorded and printed out automatically by SMDR when the timed reminder starts and is not answered.



- **If the daily alarm is set**, the display shows "*" in the corner.

Alarm 10:10AM*



Customising Your Phone

- 4.1.3 Customising the Buttons
Create or re-arrange an Alert button.

Section 4

Customising Your Phone & System

This chapter shows you how to customise your individual telephone or system according to your needs. Find the desired setting and program as necessary.

4.1 Customising Your Phone (Station Programming)

4.1.1 Customising Your Phone (Station Programming)

If you use a Panasonic proprietary telephone (e.g. KX-T7436), you can customise your telephone functions. For example, you can change the initial settings or button functions according to your needs.



- If you change your desks and the extension line, clear all settings first. The old settings will remain in the previous extension user's memory.

4.1.2 Initial Settings

The original settings are shown in bold letters in the shaded boxes. Find and mark your desired selections for programming.



- If nothing is entered within one minute in the programming mode, the mode returns to the normal status.
- To exit the mode at any time, lift the handset.

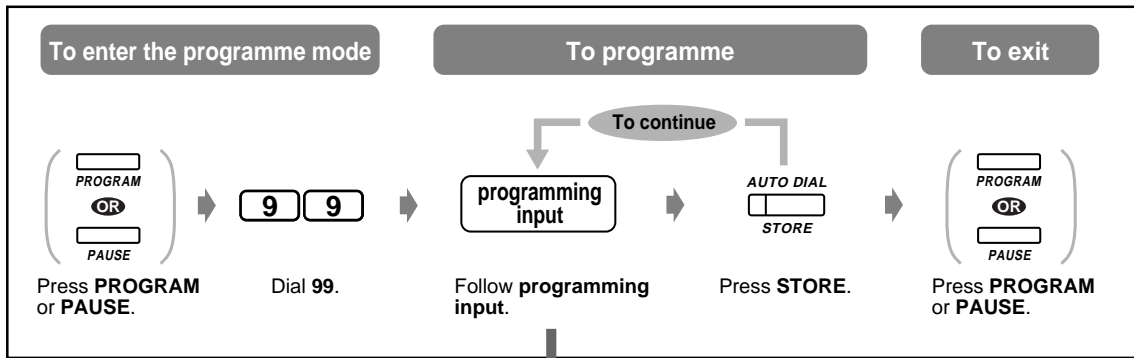

Item	Selection	Programming Input
Which line do you prefer to seize when you go off-hook to make calls? (Preferred Line Assignment – Outgoing)	<input type="checkbox"/> No line	1 1
	<input type="checkbox"/> An idle outside line	1 2
	<input type="checkbox"/> A pre-assigned outside line	1 3 Outside line no. (01–54)
	<input type="checkbox"/> The Intercom line	1 <input type="text"/> INTERCOM
Which line do you prefer to seize when you go off-hook to receive calls? (Preferred Line Assignment – Incoming)	<input type="checkbox"/> No line	2 1
	<input type="checkbox"/> A ringing line	2 2
	<input type="checkbox"/> A pre-assigned outside line	2 3 Outside line no. (01–54)
Which way do you prefer to dial the One-Touch Dialling feature? (Full One-Touch Dialling Assignment)	<input type="checkbox"/> Going Off-hook and then pressing the One-Touch Dialling button.	3 1
	<input type="checkbox"/> Pressing the One-Touch Dialling button.	3 2

Item	Selection	Programming Input
Which way do you prefer to receive an intercom call? (Intercom Alert Assignment)	<input type="checkbox"/> Ringing	4 1
	<input type="checkbox"/> Directly – the party’s voice is heard without ringing.	4 2
Do you prefer to distinguish the Call Waiting tone from an outside line and an intercom call? (Call Waiting Tone Type Selection)	<input type="checkbox"/> No. Use the same tone.	5 1
	<input type="checkbox"/> Yes. Use a different tone.	5 2
Which equipment will you use as a receiver? (Handset/Headset Selection)	<input type="checkbox"/> Handset	9 1
	<input type="checkbox"/> Headset	9 2
Which voice mail service do you prefer when a caller is recording a message in your mailbox? (Live Call Screening Mode Set)	<input type="checkbox"/> You can monitor the message through the telephone speaker. (Hands-free mode)	* 1 1
	<input type="checkbox"/> Only an alert tone is heard. (Private mode)	* 1 2

◆◆ **To confirm the current setting**

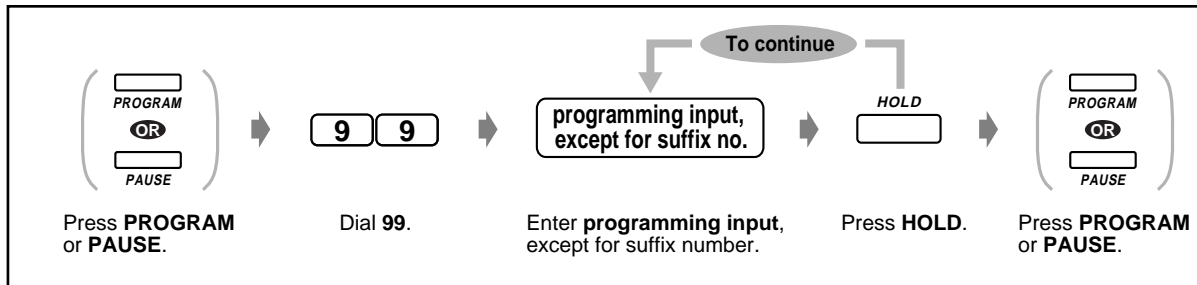

◆◆ **To clear all settings**

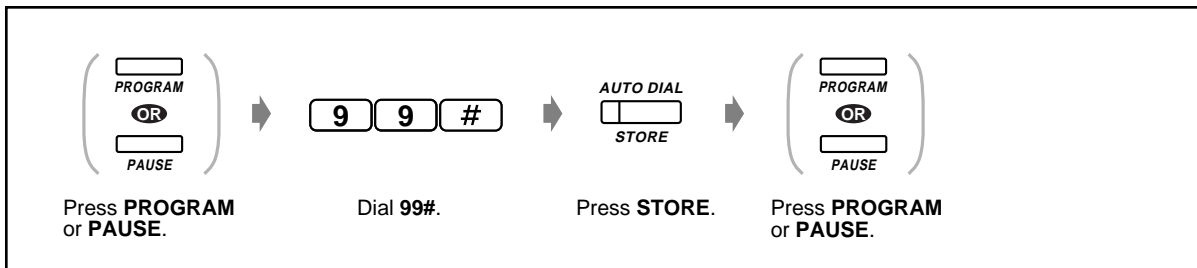

4.1.3 Customising the Buttons

You can change the flexible CO buttons, DSS buttons and programmable function (PF) buttons to the following function buttons. For example, if your telephone has more CO buttons than available outside lines, you may change an unused CO button to a one-touch dialling button.

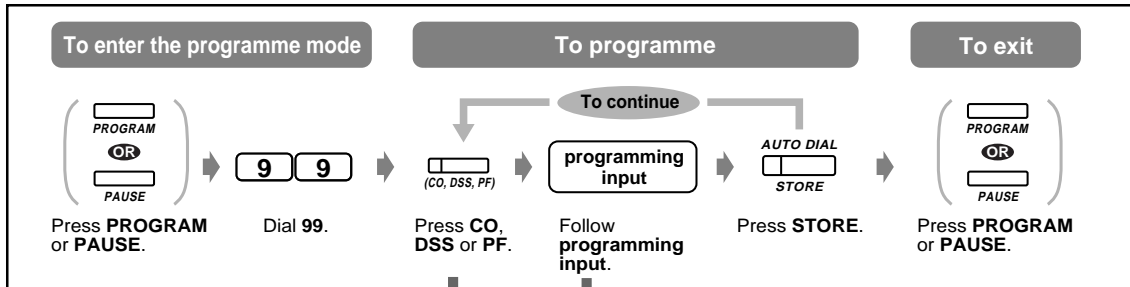

Button	Programmable Button			Programming Input
	CO	DSS	PF	
Loop-CO	✓			[*]
Group-CO	✓			[#] Outside line group no. (1–8)
Single-CO	✓			[0] Outside line no. (01–54)
Direct Station Selection (DSS)	✓	✓		[1] Extension no.
One-Touch Dialling	✓	✓	✓	[2] Desired no.*1 (max. 16 digits)
MESSAGE	✓	✓		[3]
FWD/DND (Forward/Do Not Disturb)	✓	✓	✓	[4]
SAVE	✓	✓	✓	[5]
Account	✓	✓	✓	[6]
CONF (Conference)	✓	✓	✓	[7]
Log-In/Log-Out	✓			[8][0] Receiving group no.
Voice Mail Transfer*2	✓	✓	✓	[8][2] Voice mail extension no.
Two-Way Record*2	✓	✓		[8][3] Voice mail extension no.
Two-Way Transfer*2	✓	✓		[8][4] Voice mail extension no.
Live Call Screening*2	✓	✓		[8][5]
Live Call Screening Cancel*2	✓	✓		[8][6]
Alert	✓			[8][7]
Phantom Extension	✓	✓		[8][8] Phantom extension no.
ISDN Service*3	✓	✓	✓	[8][9]
Night	✓	✓		[8][*]



- *1 "×", "#", FLASH, PAUSE, SECRET (INTERCOM) and — (CONF) can also be stored. KX-T7220 and KX-T7250 telephone users can use the PROGRAM button instead of the PAUSE button.

If you do not want to display the stored number, press the SECRET (INTERCOM) button before and after the numbers you wish to conceal.

If you store an external party's number, you should first store a line access number (9, 81 to 88).

If you need to enter an account code, you can enter the specified account code before the line access number.

<Example>

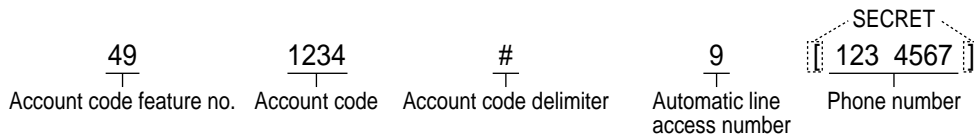

- *2 This button is used for the voice mail integration feature.
- *3 Availability of this button depends on the ISDN service of your telephone company. Refer to 2.2.6 Accessing the ISDN Network Service (ISDN Network Service Access).
- To exit the mode at any time**, lift the handset.

◆◆ **To distinguish the ringing tones for each CO button (Digital proprietary telephone only)**

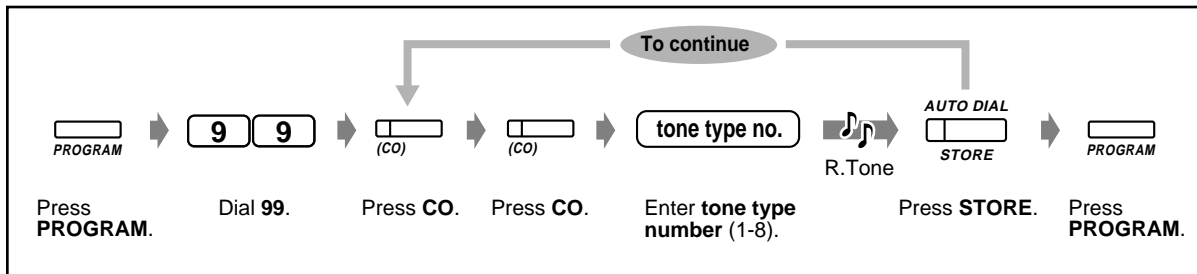

◆◆ **To set a phantom extension ringing or not (Digital proprietary telephone only)**

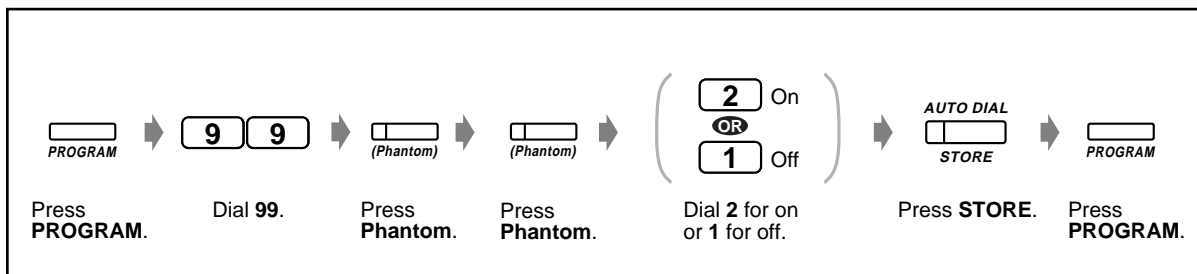

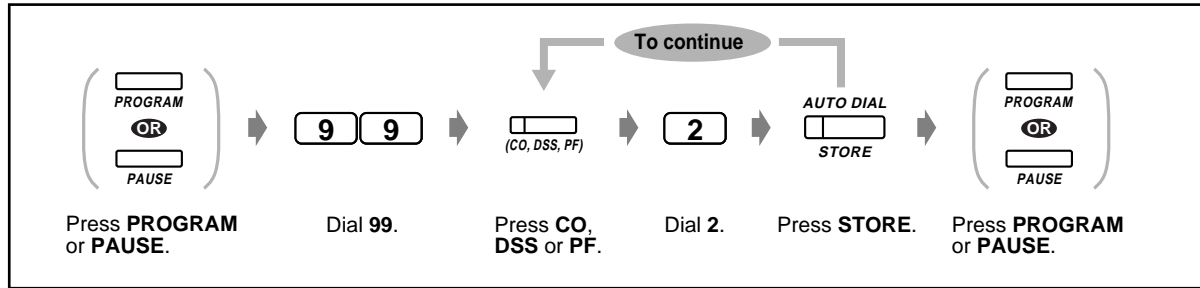
◆◆ To clear the button data

4.1.4 Charge Fee Management [Pre-assigned extension only]

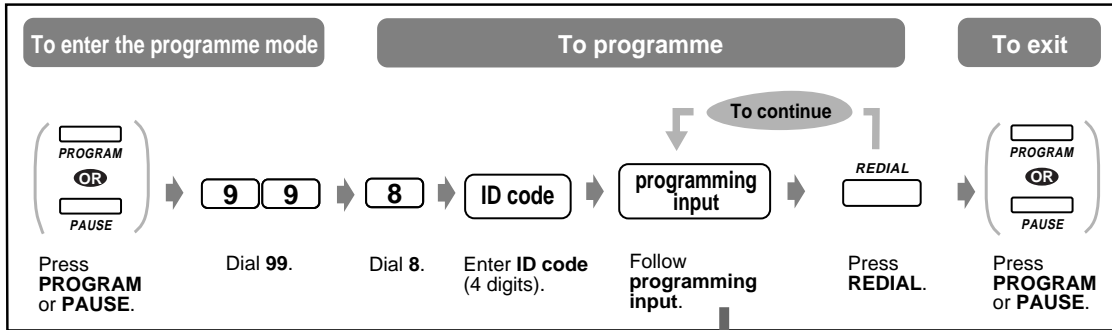

Item	Programming Input
Viewing each extension charge.	1 Extension no. <input type="text"/> SEL <input type="text"/>
Clearing each extension charge.	1 Extension no. <input type="text"/> SEL <input type="text"/> CLR <input type="text"/> AUTO DIAL STORE <input type="text"/>
Viewing each outside line charge.	2 Outside line no. (01-54) <input type="text"/> SEL <input type="text"/>
Viewing the total charge.	3 <input type="text"/> SEL <input type="text"/>
Viewing each account code charge.	4 Account table no. (001-128) <input type="text"/> SEL <input type="text"/> SEL <input type="text"/>
Clearing each account code charge.	4 Account table no. (001-128) <input type="text"/> SEL <input type="text"/> SEL <input type="text"/> CLR <input type="text"/> AUTO DIAL STORE <input type="text"/>
Assigning a new rate.	5 New rate (1-8 digits) <input type="text"/> AUTO DIAL STORE <input type="text"/>
Clearing all outside line and account code charges.	6 <input type="text"/> CLR <input type="text"/> [Displays the last clearing date and time.] <input type="text"/> AUTO DIAL STORE <input type="text"/>
Clearing all extension charges.	6 <input type="text"/> NEXT <input type="text"/> <input type="text"/> CLR <input type="text"/> [Displays the last clearing date and time.] <input type="text"/> AUTO DIAL STORE <input type="text"/>
Printing the total telephone charge (each outside line and account code charge), all extension charges or each extension charge by SMDR.	7 1 total telephone charge
	7 2 all extension charges
	7 3 Extension no. <input type="text"/> each extension charge
Assigning an account code.	8 Account table no. (001-128) <input type="text"/> <input type="text"/> CLR <input type="text"/> New account code (max.10 digits) <input type="text"/> AUTO DIAL STORE <input type="text"/>



- If you return to the initial display after programming input, press the HOLD button instead of the REDIAL button.

4.2 Customising Your System (System Programming)

4.2.1 Programming Information

You can customise your system according to your application. You can control telephone conditions for each extension, extension group, Class of Service, etc.. For example, you can restrict some extensions from calling external parties. Furthermore, the programmed data, such as system speed dialling, can be used by all extensions.

Your system already has default settings (factory installed). Most of the programming is done by your dealer. Consult your dealer about system applications and re-programming according to your needs. Only frequently changed programming items (User Programming) are shown in this manual. If you would like to change the following features, extensions which meet certain conditions can re-programme them at any time.

The available programming is shown below. (Programme number)

- The date and time (000)
- System speed dialling numbers and names (001/002)
- Extension number and name (003/004)

Required Telephone

A Panasonic Proprietary Telephone with display (e.g. KX-T7433, KX-T7436)

User Password

To enter the programming mode, a user password (4-7digits) is required. It should be programmed through system programming beforehand. Check your password (Default:1234).

Conditions

Only one extension, which is on-hook and holding no calls, is available at one time. If another extension is programming, "Another Use" is displayed.

List

Before programming, decide your selections and write them down in the list for each programming item. These are useful for easy programming and future reference. Your dealer also has programming tables which contain all of the assignments. You may ask for photo copies of these tables to be aware of the features /conditions available.

Overlay / Button Function

The overlay is a paper sheet which is included with the telephone.

In the programming mode, the button functions are different. The overlay shows the functions in the programming mode. Place the overlay on the telephone properly.

If your telephone display shows the necessary functions, the overlay may be not required.

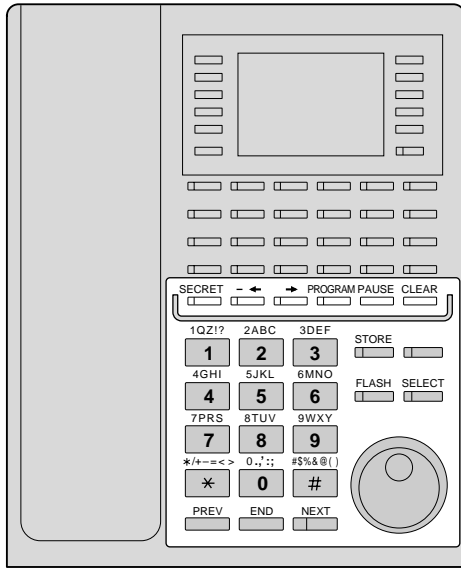

KX-T7436 with the overlay

Display

The display gives you useful messages about programming. The multiple-line display also shows the available functions. Follow the message at each step. This is a display sample in the initial programming mode.

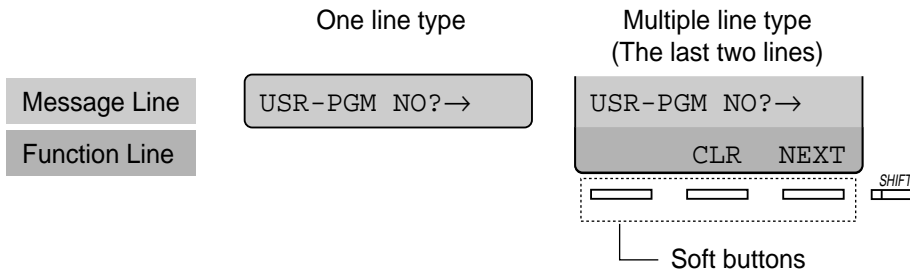

The message line guides you through programming and lets you confirm your selection. For example, when "Jack No?->" is displayed, enter the jack number. The display shows up to 16 characters at a time. To scroll the display, press → or ←. The function line shows you the function of the Soft button located below it. When the SHIFT button light beside the display is on, subtitles are available. Press the SHIFT button to confirm the available functions.

Jack Number / Extension Number

Certain programming is assigned to each jack number. The jack number is where your telephone connects to the system. If two telephones share one jack and have their own extension number (eXtra Device Port [XDP]), the jack number is determined as Jack XX-1 for a proprietary telephone and Jack XX-2 for a single line telephone. The display may show XX-2, even if an extension has not set XDP. **If you do not know the jack number or extension number,** check it as shown on the next page.

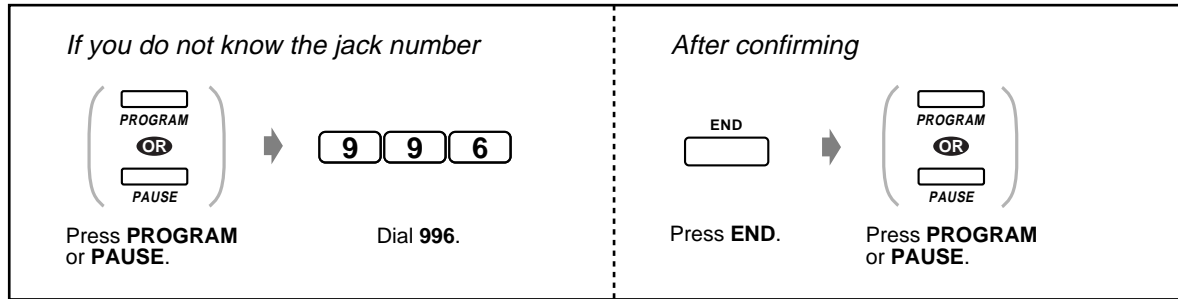

Confirmation

To confirm your entry after storing data;

- The STORE button light: Lights red.
- Confirmation Tone:
 - One beep: Your entry is accepted.
 - Three beeps: Your entry is rejected.

◆◆ Icon Descriptions

Icons are given to guide you through programming. The following is an example of how the icons may be used:



Enter the programme number. (xxx= the specified number)



Press the corresponding button on the telephone or the Soft button which corresponds to the display.

<Example>

 : "NEXT" is displayed.

In this case, both of the following methods are available:

- Press the NEXT () button.
- Press the Soft button which corresponds to "NEXT" shown on the display.



The display messages "SEL+", "SEL-" and "SEL" mean "SELECT."
"CLR" means "CLEAR."



Press the button until the desired entry appears.



Enter your selection.

<Example>

 : "Jack no." is displayed. Enter the jack number.

◆◆ Procedure

The basic steps are shown below.

1. Entering the programming mode



2. Programming

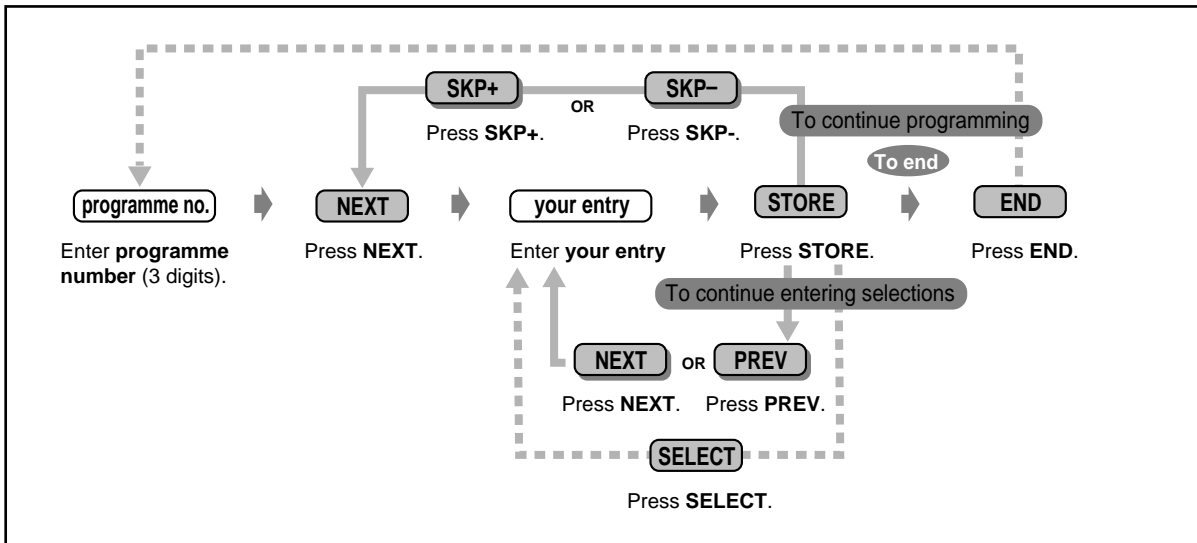

→ To go to the next/previous programme or entry.
 - - - → To enter the desired programme or entry.



- **To delete or change an entry**, press CLEAR (TRANSFER).
- **To confirm your entry after storing data:**
 - The STORE button light: Lights red.
 - Confirmation Tone:
 - One beep: Your entry is accepted.
 - Three beeps: Your entry is rejected.
- **To exit the programming mode at any time**, lift the handset.

3. Exiting the mode

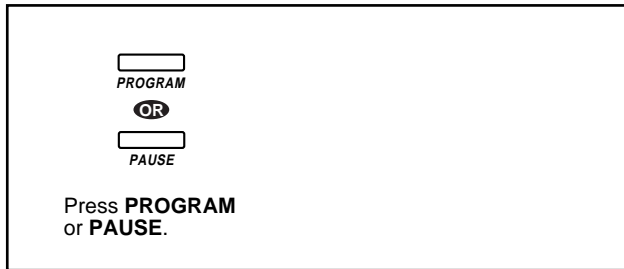

◆◆ Character Entry

When storing a name or message, enter the characters as follows. The tables on the next page show you the characters available for each key. You can enter letters by pressing the alphanumeric keys on your telephone.

Example: Key 2 can enter A, a, B, b, C or c.

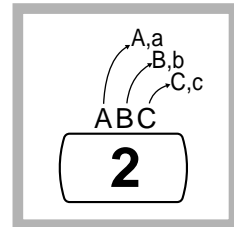

Entering characters

- Press the desired character key.
- Press the matching Soft button, press the SELECT (AUTO ANSWER) button or rotate the Jog Dial as needed.
- Repeat the appropriate steps for the remaining characters.



- **To erase the last letter**, press the ← (CONF) button.
- **To erase all letters**, press the CLEAR (TRANSFER) button.
- **To alternate between capital and lower case letters**, press the SHIFT button. Once this button is pressed, the mode remains until the SHIFT button is pressed again.













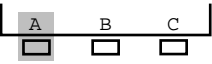

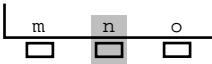
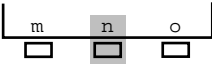
Combination Table 1

Jog Dial keys	Display sequence by rotating the Jog Dial
1	1 Q q R r S s T t ...
2	2 A a B b C c D d ...
3	3 D d E e F f G g ...
4	4 G g H h I i J j ...
5	5 J j K k L l M m ...
6	6 M m N n O o P p ...
7	7 P p Q q R r S s ...
8	8 T t U u V v W w ...
9	9 W w X x Y y Z z (space) ...
0	0 (space) ! ? . , ' : ; ...
*	* / + - = < > # \$...
#	# \$ % & @ () A a B b ...

Combination Table 2

SHIFT & Soft button keys		S1	SHIFT+S1	S2	SHIFT+S2	S3	SHIFT+S3	SHIFT+SHIFT+S1	SHIFT+SHIFT+S2
SELECT button pressing times	0	1	2	3	4	5	6	7	8
1	1	Q	q	Z	z	!	?		
2	2	A	a	B	b	C	c		
3	3	D	d	E	e	F	f		
4	4	G	g	H	h	I	i		
5	5	J	j	K	k	L	l		
6	6	M	m	N	n	O	o		
7	7	P	p	Q	q	R	r	S	s
8	8	T	t	U	u	V	v		
9	9	W	w	X	x	Y	y	Z	z
0	0	(space)	.	,	'	:	;		
*	*	/	+	-	=	<	>		
#	#	\$	%	&	@	()		

<Example> To enter "Ann."

A	n	n
– Using the Jog Dial [2]  until "A" is displayed.	[6]  until "n" is displayed.	[6]  until "n" is displayed.
– Using a soft button. [2] 	[6]  	[6] 
– Using the SELECT button. [2] 	[6]    	[6]    

4.2.2 Date and Time Set (000)

After setting the current date and time, the proprietary telephone displays the current date and time while on-hook.

Default : '95 Jan. 1 SUN 0:00 AM

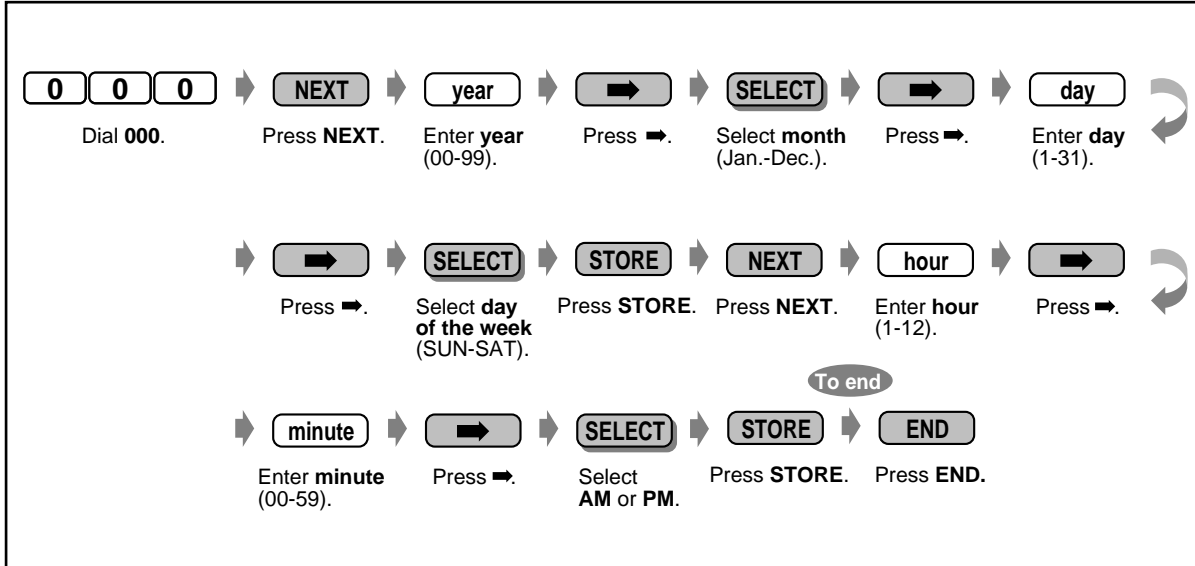

- **After changing the desired entries**, you can press the STORE button. You do not have to perform the rest of the steps.
- The clock starts immediately after the STORE button is pressed.
- You cannot leave an entry empty.
- The clock is automatically adjusted in case of ISDN.

4.2.3 System Speed Dialling Number Set (001)

You can store the phone numbers of up to 500 frequently dialled numbers.

Default : No entry

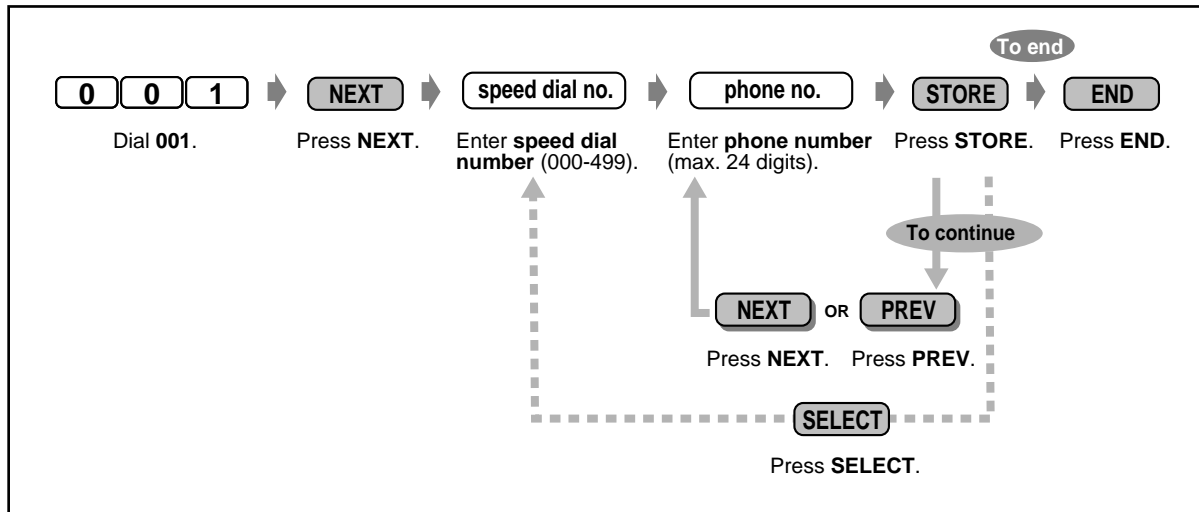

- The programming list is to refer to "Programming List for 001/002" in 4.2.4 System Speed Dialling Name Set (002). The directory is to refer to "System Speed Dialling" in 6.3.1 Directory.
- If the desired number is more than 24 digits, divide the number and store it into two or more speed dial numbers.
- "*", "#", FLASH, PAUSE, SECRET (INTERCOM) and — (CONF) can also be stored.
If you do not want to display the stored number, press the SECRET (INTERCOM) button before and after the numbers you wish to conceal.
If you store an external party's number, you should first store a line access number (9, 81 to 88).
If you need to enter an account code, you can enter the specified account code before the line access number.

<Example>

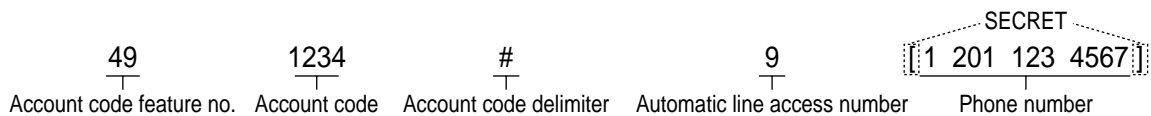

- The System Speed Dialling numbers are used for the call identification. For a proper operation, a hyphen must be inserted after the line access number. Additionally, the area code must be stored always (even for local numbers in the same area).

4.2.4 System Speed Dialling Name Set (002)

You can store the corresponding name of the speed dialling number. These names are displayed when making call with the display operation. (See "How to Use the Display" (Operation).) To enter characters, refer to "Character Entry" in 4.2.1 Programming Information.

Default : No entry

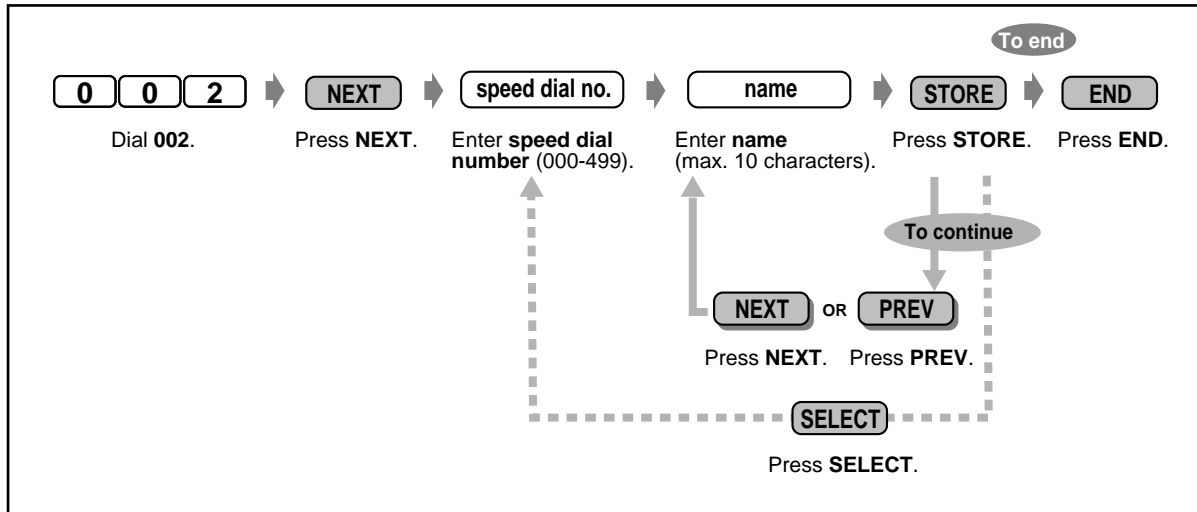

- The programming list is to refer to "Programming List for 001/002" in 4.2.4 System Speed Dialling Name Set (002). The directory is to refer to "System Speed Dialling" in 6.3.1 Directory.

Programming List for 001/002

Speed dial no.	Name	Phone no.	Speed dial no.	Name	Phone no.
000			046		
001			047		
002			048		
003			049		
004			050		
005			051		
006			052		
007			053		
008			054		
009			055		
010			056		
011			057		
012			058		
013			059		
014			060		
015			061		
016			062		
017			063		
018			064		
019			065		
020			066		
021			067		
022			068		
023			069		
024			070		
025			071		
026			072		
027			073		
028			074		
029			075		
030			076		
031			077		
032			078		
033			079		
034			080		
035			081		
036			082		
037			083		
038			084		
039			085		
040			086		
041			087		
042			088		
043			089		
044			090		
045			091		

Speed dial no.	Name	Phone no.	Speed dial no.	Name	Phone no.
092			138		
093			139		
094			140		
095			141		
096			142		
097			143		
098			144		
099			145		
100			146		
101			147		
102			148		
103			149		
104			150		
105			151		
106			152		
107			153		
108			154		
109			155		
110			156		
111			157		
112			158		
113			159		
114			160		
115			161		
116			162		
117			163		
118			164		
119			165		
120			166		
121			167		
122			168		
123			169		
124			170		
125			171		
126			172		
127			173		
128			174		
129			175		
130			176		
131			177		
132			178		
133			179		
134			180		
135			181		
136			182		
137			183		

Speed dial no.	Name	Phone no.	Speed dial no.	Name	Phone no.
184			230		
185			231		
186			232		
187			233		
188			234		
189			235		
190			236		
191			237		
192			238		
193			239		
194			240		
195			241		
196			242		
197			243		
198			244		
199			245		
200			246		
201			247		
202			248		
203			249		
204			250		
205			251		
206			252		
207			253		
208			254		
209			255		
210			256		
211			257		
212			258		
213			259		
214			260		
215			261		
216			262		
217			263		
218			264		
219			265		
220			266		
221			267		
222			268		
223			269		
224			270		
225			271		
226			272		
227			273		
228			274		
229			275		

Speed dial no.	Name	Phone no.	Speed dial no.	Name	Phone no.
276			322		
277			323		
278			324		
279			325		
280			326		
281			327		
282			328		
283			329		
284			330		
285			331		
286			332		
287			333		
288			334		
289			335		
290			336		
291			337		
292			338		
293			339		
294			340		
295			341		
296			342		
297			343		
298			344		
299			345		
300			346		
301			347		
302			348		
303			349		
304			350		
305			351		
306			352		
307			353		
308			354		
309			355		
310			356		
311			357		
312			358		
313			359		
314			360		
315			361		
316			362		
317			363		
318			364		
319			365		
320			366		
321			367		

Speed dial no.	Name	Phone no.	Speed dial no.	Name	Phone no.
368			414		
369			415		
370			416		
371			417		
372			418		
373			419		
374			420		
375			421		
376			422		
377			423		
378			424		
379			425		
380			426		
381			427		
382			428		
383			429		
384			430		
385			431		
386			432		
387			433		
388			434		
389			435		
390			436		
391			437		
392			438		
393			439		
394			440		
395			441		
396			442		
397			443		
398			444		
399			445		
400			446		
401			447		
402			448		
403			449		
404			450		
405			451		
406			452		
407			453		
408			454		
409			455		
410			456		
411			457		
412			458		
413			459		

Speed dial no.	Name	Phone no.
460		
461		
462		
463		
464		
465		
466		
467		
468		
469		
470		
471		
472		
473		
474		
475		
476		
477		
478		
479		
480		
481		
482		
483		
484		
485		
486		
487		
488		
489		
490		
491		
492		
493		
494		
495		
496		
497		
498		
499		

4.2.5 Extension Number Set (003)

You can assign an extension number to each jack.

Default : Jack no. = Extension no.

KX-TD816 —	01-1 to 16-1= 101 to 116
	01-2 to 16-2= 201 to 216
KX-TD1232 —	01-1 to 64-1= 101 to 164
	01-2 to 64-2= 201 to 264

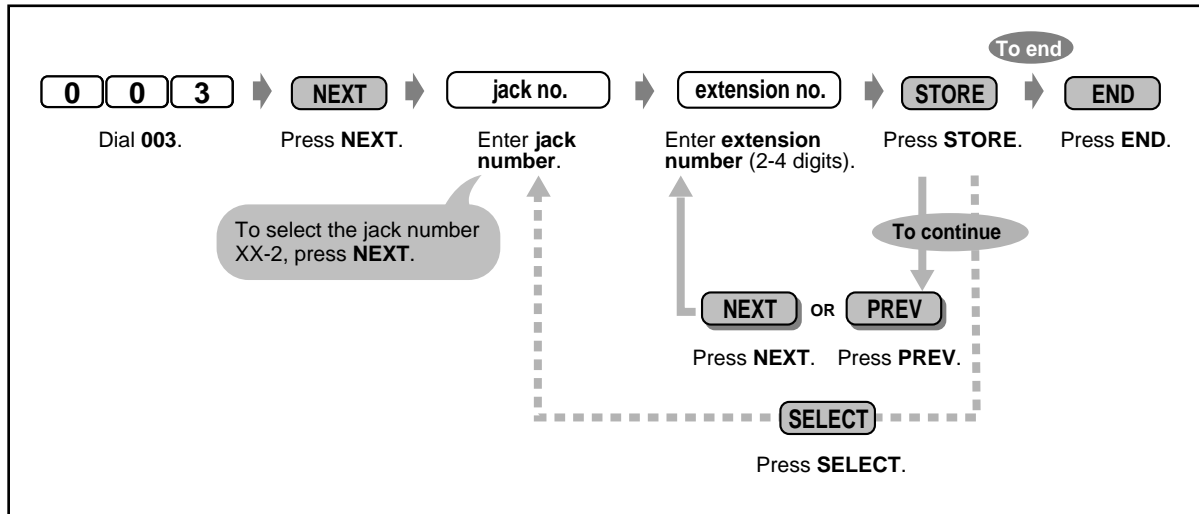

- The leading number(s) should be the same as the assigned number(s) for Flexible Numbering. Consult your dealer.
- A double entry is invalid.

4.2.6 Extension Name Set (004)

You can store the name of an extension user. This is useful if you want to know who is calling, or who you are calling when making an intercom call using the directory.

To enter characters, refer to "Character Entry" in 4.2.1 Programming Information.

Default : No entry

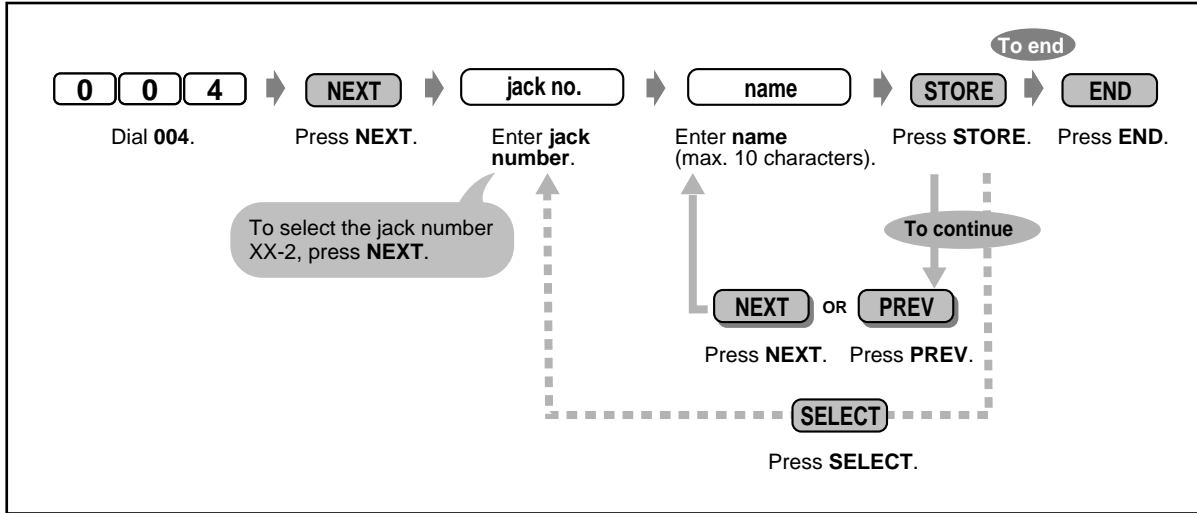

Programming List for 003/004

Jack no.	Extension no.	Name	Jack no.	Extension no.	Name
01-1			01-2		
02-1			02-2		
03-1			03-2		
04-1			04-2		
05-1			05-2		
06-1			06-2		
07-1			07-2		
08-1			08-2		
09-1			09-2		
10-1			10-2		
11-1			11-2		
12-1			12-2		
13-1			13-2		
14-1			14-2		
15-1			15-2		
16-1			16-2		
17-1			17-2		
18-1			18-2		
19-1			19-2		
20-1			20-2		
21-1			21-2		
22-1			22-2		
23-1			23-2		
24-1			24-2		
25-1			25-2		
26-1			26-2		
27-1			27-2		
28-1			28-2		
29-1			29-2		
30-1			30-2		
31-1			31-2		
32-1			32-2		

Jack no.	Extension no.	Name	Jack no.	Extension no.	Name
33-1			33-2		
34-1			34-2		
35-1			35-2		
36-1			36-2		
37-1			37-2		
38-1			38-2		
39-1			39-2		
40-1			40-2		
41-1			41-2		
42-1			42-2		
43-1			43-2		
44-1			44-2		
45-1			45-2		
46-1			46-2		
47-1			47-2		
48-1			48-2		
49-1			49-2		
50-1			50-2		
51-1			51-2		
52-1			52-2		
53-1			53-2		
54-1			54-2		
55-1			55-2		
56-1			56-2		
57-1			57-2		
58-1			58-2		
59-1			59-2		
60-1			60-2		
61-1			61-2		
62-1			62-2		
63-1			63-2		
64-1			64-2		



- The directory is on 6.3.1 Directory.

Section 5

DECT Portable Station

This chapter shows you how to operate each DECT Portable Station feature step by step. Read this chapter to become familiar with the many useful features of this DECT system. The KX-TD816 and KX-TD1232 systems optionally support the DECT system.

5.1 Safety Instructions

5.1.1 Safety Instructions

Take special care to follow the safety suggestions listed below to use the Panasonic DECT Portable Station (PS).

◆◆ Safety

1. The charger should be connected to a power supply only of the type described in the operating instructions or as marked on the charger.
2. When the PS is not being used, turn the power off. When left unused for a long period of time, the charger should be unplugged from the household AC outlet.

◆◆ Installation

Environment

1. Do not use this PS and the charger near water – for example, near a bath tub, washbowl, sink, etc. Damp basements should also be avoided.
2. The PS and the charger should be kept away from heat sources such as radiators, kitchen ranges, etc. They also should not be placed in rooms where the temperature is less than 5°C or greater than 40°C.

Placement

1. Do not place heavy objects on top of the PS and charger.
2. Care should be taken so that objects do not fall onto and liquids are not spilled into the PS and charger. Do not subject the PS and charger to excessive smoke, dust, mechanical vibration, or shock.
3. Place the charger on a flat surface.

◆◆ Battery

To reduce the risk of fire or injury to persons, read and follow these instructions.

1. Use only the battery specified.
2. Do not dispose of the battery in a fire. It may explode. Check with local waste management codes for special disposal instructions.
3. Do not open or mutilate the battery. Released electrolyte is corrosive and may cause burns or injury to the eyes or skin. The electrolyte may be toxic if swallowed.
4. Exercise care in handling the battery in order not to short the battery with conductive materials such as rings, bracelets, and keys. The battery and/or conductor may overheat and cause burns.
5. Do not recharge batteries, which are provided or specified as replacement parts for use with other products. The battery may leak corrosive electrolyte or explode.
6. Do not attempt to rejuvenate the battery provided with or identified for use with this product by heating. Sudden release of battery electrolyte may occur causing burns or irritation to eyes or skin.
7. Remove the battery from this product if the product will not be used for a long period of time (several months or more). During this time the battery could leak in the product.
8. Discard the "dead" battery as soon as possible. A "dead" battery may leak in the product.

9. Do not store this product, or the battery provided with or identified for use with this product, in high temperature areas. Batteries that are stored in a freezer or refrigerator for the purpose of extending shelf life should be protected from condensation during storage and defrosting. Batteries should be stabilised at room temperature prior to use after cold storage.

◆◆ **For Best Performance**

Operating Range

1. The range of operation depends on the topography of your office, weather or usage conditions, because signals are transmitted between the Cell Station (CS) and the PS by radio waves.
2. Normally, you will get greater range outdoors than indoors. If there are obstacles such as walls, noise may interfere with your telephone calls. In particular, high metal shelves or reinforced concrete walls will shorten your operating range.
3. A PS may not work if used in places that are too far from the CS depending on the structure of the building.

Noise

Occasional noise or interference may occur due to other sources of electromagnetic radiation, such as refrigerators, microwave ovens, faxes, TVs, radios, or personal computers. If noise affects your telephone calls, keep the PS away from other electrical appliances.

WARNING

TO PREVENT FIRE OR SHOCK HAZARD, DO NOT EXPOSE THIS PRODUCT TO RAIN OR ANY TYPE OF MOISTURE.

5.2 Before Operating the DECT Portable Station

5.2.1 Before Operating the DECT Portable Station

◆◆ What is the DECT Portable Station?

You can use a Panasonic DECT Portable Station (PS), KX-TD7500, by connecting an optional wireless system to your PBX, KX-TD816 or KX-TD1232. It can be used in the system with other telephones.

Capacity

You can use the following number of PS in each system.

KX-TD816 16

KX-TD1232 64

Up to four calls can be made at the same time in the range.



◆◆ Registration

You must register your PS in the system and determine its extension number before initial use. For PS registration, consult your dealer.

◆◆ Display

The display has two lines with 16 characters per line, and related symbols to show information for your phone activities.

Furthermore, your PS can show the guidance messages which show the selectable buttons and help you operate your PS without the operating instructions. Refer to 5.4.2 PS Programming.

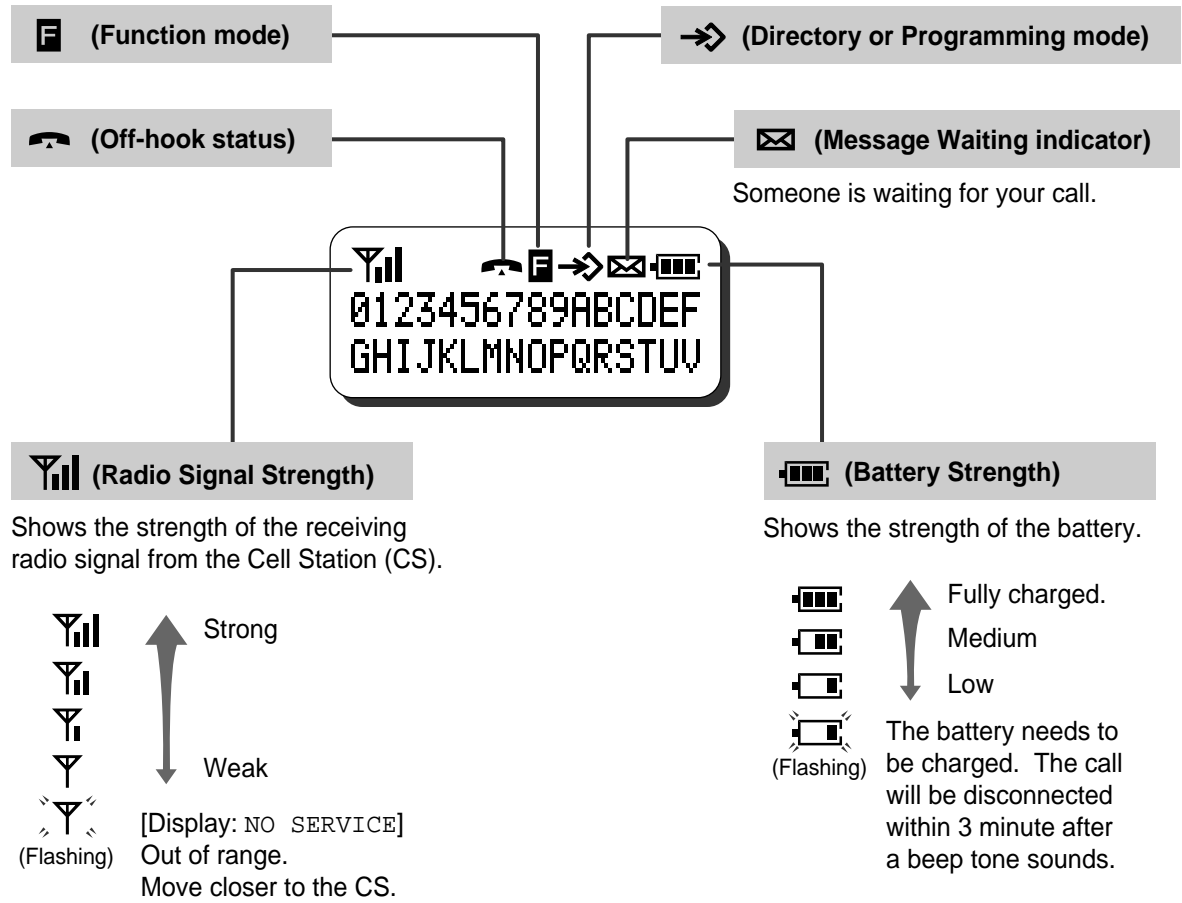

◆◆ **Battery Charge**

You need to charge the battery before initial use and when the battery strength becomes low. When "🔋" flashes or beep tones sound every five seconds during a conversation or "BATTERY EMPTY" is displayed, recharge the battery or replace with a fully charged optional spare battery. If not, the call will be automatically disconnected in three minutes.

Standard Battery Life

If your Panasonic battery is fully charged [provided 25°C]:

While in use (Talk mode)	Up to about 10 hours
While not in use (Stand-by mode)	Up to about 100 hours

To install a battery

Hook the bottom of the battery on the PS, and place the battery until it clicks.

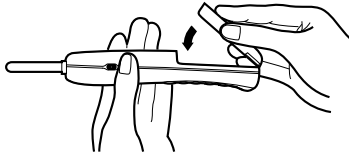

To replace a battery

Set the power switch to OFF first to prevent memory loss, and then remove the battery while pressing the tab.

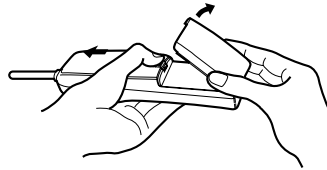

To charge the battery

- a) Connect the charger to a power outlet using the AC adaptor.
- b) Slide the battery-attached portable station or the battery in the charger.
 - Charge the battery for about 1.5 hours.
 - When charging is completed, the charge indicator will change from orange to green.

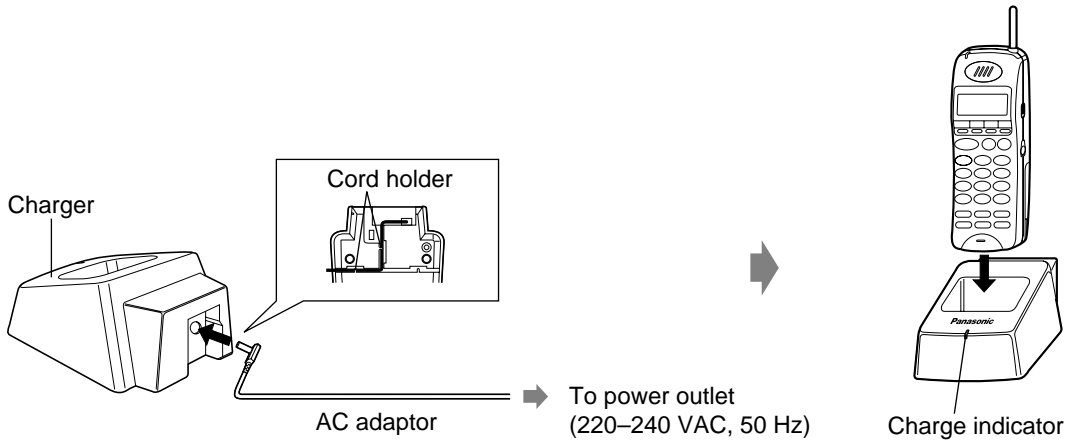

- The battery is used while the PS's power is ON.
- Battery life may vary depending on usage conditions and ambient temperature.
- Please use only a Panasonic battery.
- Do not let the charged battery's electrodes touch metallic objects. The terminal may short and overheat, causing burns.
- Clean the charge contacts on both the PS and the charger with a soft cloth once a month, or the battery may not charge properly.
- The PS can receive calls even while charging.
- You need not worry about overcharging.



- The AC adaptor is used as the main disconnect device. Ensure that the socket-outlet is located near the equipment for easily access.

◆◆ **Feature Numbers**

To operate certain features, you need to enter specified feature numbers (and an additional parameter, if required).

There are two types of feature numbers as follows:

- Flexible feature number
- Fixed feature number

Fixed feature numbers cannot be changed. However, you can change the flexible numbers to other numbers for easier use. If you want to change the numbers, consult your dealer. In this manual, the default numbers (factory installed) are used for operations.

A flexible number is shown as  (half-shaded key). Use the new programmed number if you have changed the feature number. Write the new number in Section 6.2.1 Feature Number List (Appendix).

◆◆ **Your Extension Number / DECT System Number**

You can check your own extension number or/and the connected DECT System number on the display if set to be shown by PS Programming. Refer to 5.4.2 PS Programming – Standby Display Selection.

◆◆ **Tones**

You will hear various tones, during or after an operation, for confirmation. Refer to 6.4.1 What is This Tone? (Appendix).

◆◆ **Examples**

The displays and the illustrations shown as examples are from a PS connected to the KX-TD1232.

◆◆ **Restrictions**

Some features may be restricted at your PS under system programming. Consult your manager or dealer.













◆◆ **Icon Descriptions**

There are some icons which show you the feature availability, notes and action to operate the features. For details, refer to 2.1.1 Before Operating the Telephones – Icon Descriptions (Operation).

While operating the PS, you can easily refer to the Icons noted on the inside back cover of this manual.











◆◆ Button Descriptions

Your PS has the useful function buttons listed below. These buttons make operations simple.

	<p>INTERCOM Button: Used to make or receive intercom calls.</p>		<p>Flexible CO Buttons (F1 through F3): Used to make or receive an outside call. A Loop-CO button is already assigned to F1 button. Pressing this button seizes an idle line automatically. F2 and F3 button can be used as the desired function buttons. (Button assignment is required.) If the term is in parentheses like (Save), it means this button has been made into an "Save" button.</p>
	<p>TALK Button: Used to make, receive or end calls.</p>		
	<p>CANCEL Button: Used to end calls, or exit the directory or Function mode.</p>		
	<p>CLEAR / TRANSFER Button: Used to clear incorrect digits while entering numbers or transfer a call to another extension.</p>		<p>BOOK Button: Used to enter into the directory mode or select a menu in the Function mode.</p>
	<p>HOLD Button: Used to place a call on hold.</p>		<p>FLASH Button: Used to disconnect a current call and make another call. Or used to send a flash signal to the Central Office or another connected PBX, if you programme "EFA" (External Feature Access) to the FLASH button by system programming.</p>
	<p>FUNCTION Button: Used to enter into the Function mode or access features by pressing additional keys.</p>		<p>Power Switch: Used to switch the power ON (●) or OFF (○).</p>
	<p>AUTO / OK Button: Used for System Speed Dialling and storing programme changes.</p>		<p>Volume Control Button: Used to select the ringer volume (seven levels, off and vibration mode) during on-hook or ringing status, or receiver volume (three levels) during a conversation. The volume levels are indicated by the number of asterisks on the display.</p>
	<p>REDIAL Button: Used to redial the last number dialled.</p>		

Combination Buttons*

Some special features can be used by combining two buttons.

 	PAUSE Button (⏸): Used to insert a pause in numbers.	 	CONF (Conference) Button (△): Used to establish a three party conversation.
 	FWD/DND Button (↶/↷): Used to set the Call Forwarding or Do Not Disturb (DND) features.	 	TONE Button: Used to change the dialling mode temporarily to tone.
 	MESSAGE Button (✉): Used to leave a message waiting indication or call back the party who left the message waiting indication.		



* These buttons can also be activated using the display. Refer to 5.3.9 Selecting the Feature Button on the Display

◆◆ How to Follow the Steps

A sample operation is shown below.

Feature title

5.3.6 Using the Call Directories

◆◆

Storing the names and numbers

You can store, edit or delete the PS Dialling Directory or PBX Station Speed Dialling Directory items on your PS.

Sub feature title

◆◆

Storing the names and numbers

You can store, edit or delete the PS Dialling Directory or PBX Station Speed Dialling Directory items on your PS.

Description

◆◆

Storing the names and numbers

You can store, edit or delete the PS Dialling Directory or PBX Station Speed Dialling Directory items on your PS.

Operation steps

The display examples may be shown on the shaded part to help you operate.

The description of the icons are explained on page 174 and the inside back cover of this manual.

◆◆

Storing the names and numbers

You can store, edit or delete the PS Dialling Directory or PBX Station Speed Dialling Directory items on your PS.

Conditions

- To store a phone number only, skip the step for entering name.
- *1 To enter characters, see page 190.
- *2 The line access number is not required.

◆◆

Storing the names and numbers

You can store, edit or delete the PS Dialling Directory or PBX Station Speed Dialling Directory items on your PS.

Hints

!! You can lock the Call Directories to prevent other people from seeing your directory display.

◆◆

Storing the names and numbers

You can store, edit or delete the PS Dialling Directory or PBX Station Speed Dialling Directory items on your PS.

Customising Your PS

- 5.4.2 PS Programming – To change the initial settings
 - Directory Lock Control
 - Lock or unlock the Call Directories.

Programming References: The related or required programming is noted. To programme, see “Customising Your PS” in this section.

PS

F

BOOK

➔

↵OK

➔

↵OK

➔

name

➔

↵OK

MODIFY BOOK

PS-NEW-ENTRY

ENTER NAME
=1/99 REMAINS

<Example>
Panasonic

Panasonic
ENTER PHONE-NO.

Press **FUNCTION** and **BOOK**. Press **OK**. Press **OK**. Enter **name***1 (max. 16 characters). Press **OK**.

➤

phone no.

➔

↵OK

➔

C

Panasonic
0123456789

STORED

Enter **phone number***2 (max. 32 digits). Press **OK**. Press **CANCEL**.

5.3 Operation

5.3.1 Making Calls

◆◆ Calling another extension

◆ To another extension (Intercom Call)

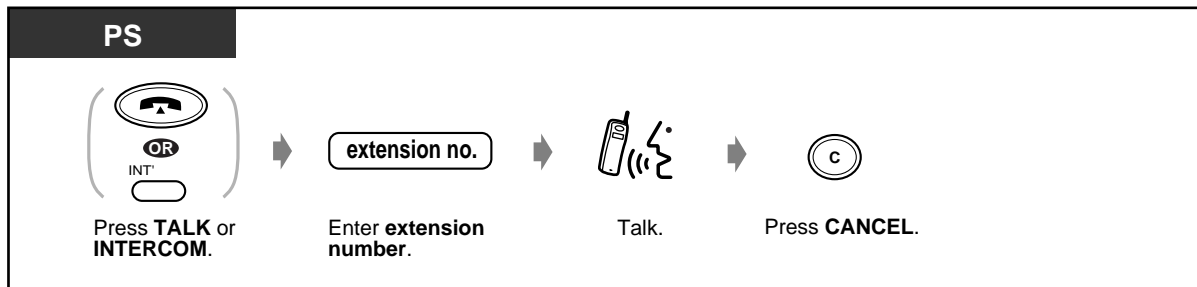

<Example>

When you call Mr. Thomas....

Mr. Thomas's extension number is 123.

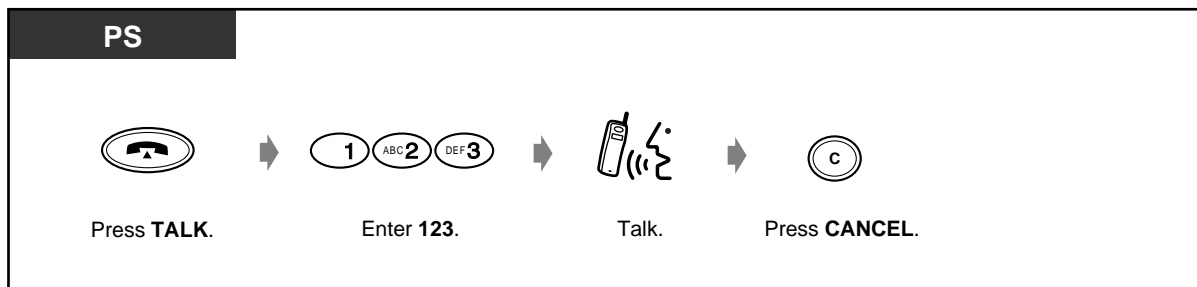

- You can also finish the conversation by placing the PS on the charger or pressing TALK button.
- If " Ψ " flashes, move towards the Cell Station until the sign stops flashing and try again.









- Do you have an extension directory?**
Complete the directory in 6.3.1 Directory and make a copy for your reference.
- Confirming the dialled number before connecting**
You can go off-hook after confirming the number you dialled. If you misdial, press the CLEAR button to clear each number from the right.
- If you go off-hook first and then misdial,**
press the FLASH button and enter the number again.
- Handover**
Even if you move during a conversation, the linking Cell Station (CS) will automatically switch without disconnecting the call.
Handover is available only during a conversation (except a conference call). It is not available when a switched CS is busy or there is no CS in the new range.

◆◆ Calling an external party

You have to seize an outside line before dialling an outside phone number because external calls are made via your system.

Select one of the following methods:

- Press an idle  button.
- Dial automatic line access number .
An idle line is selected automatically.
- Dial outside line number   to  .

◆ Using a Flexible CO button

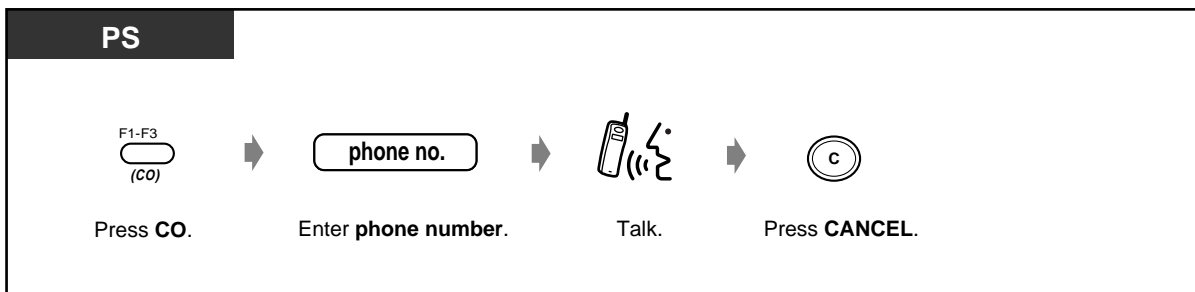

◆ Using automatic line access number / outside line number

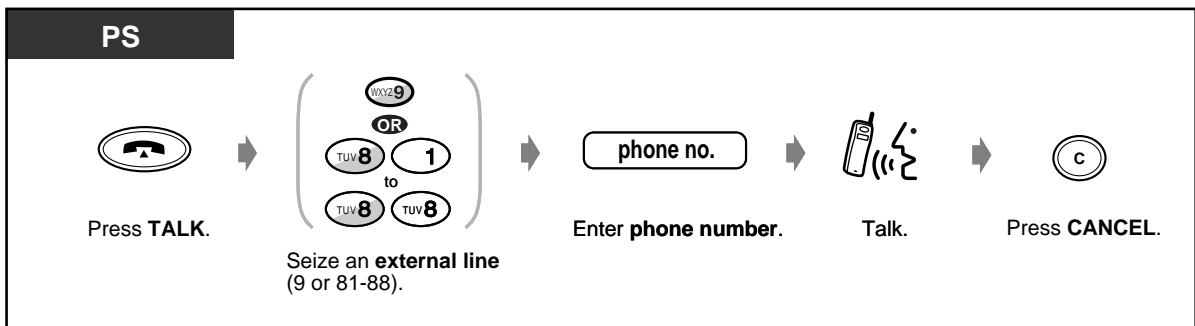

- You can also finish the conversation by placing the PS on the charger or pressing TALK button.
- If " ∇ " flashes, move towards the Cell Station until the sign stops flashing and try again.



- **Emergency call**

You can dial pre-programmed emergency numbers without any restrictions. In this case, you can make an emergency call without seizing an outside line.

- **To select the less expensive line automatically**, dial "9" or press the Loop-CO button to seize a line. (**Automatic Route Selection**) F1 button is already assigned as the Loop-CO button.

- **Confirming the dialled number before connecting**

You can go off-hook after confirming the number you dialled. If you misdial, press the CLEAR button to clear each number from the right.

- **If you go off-hook first and then misdial**, press the FLASH button and enter the number again.

- **Call information**

The following information can be referred to by repeatedly pressing the FWD/DND button as follows:

< Example >

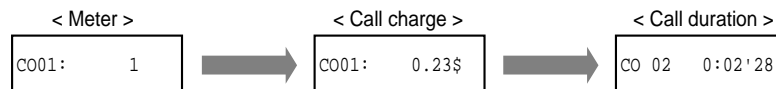

Customising Your PS

- 5.4.3 PBX Programming– Customising the Buttons

Create or re-arrange the Loop-CO button, Group-CO button and Single-CO button.

5.3.2 Receiving Calls

When you receive a call, the DECT portable station (PS) rings or vibrates, and the outside line number or extension number of the receiving call will appear on the display.

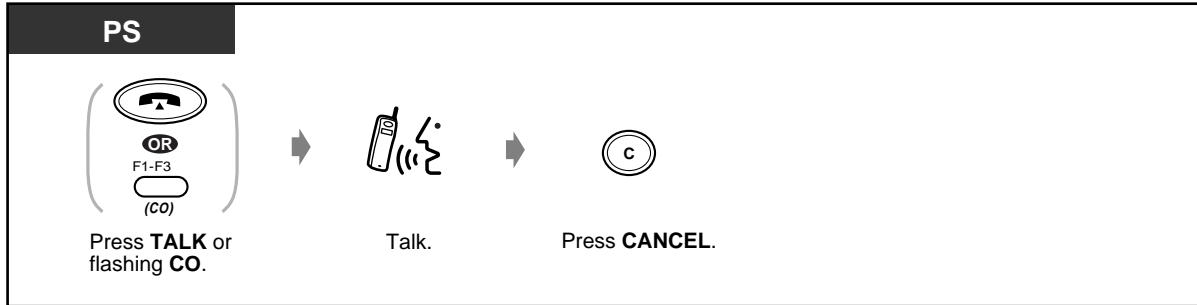

- You can hang up also by pressing the TALK button or placing the PS on the charger.
- If you set "INT/CO" or "INT ONLY" to the Automatic Answer Mode (PS Programming) and connect the headset, your phone will answer incoming calls automatically. If you leave your PS unattended with the headset connected, the following problems will occur.

- The PS will answer calls and the calling party will be charged even though you are not there to take the call.
- Depending on the line, even if the calling party disconnects the call, the DECT line may remain connected until you disconnect the call manually or the battery expires. The PBX trunk may also remain connected to the network.

Please note the following:

- Please set "INT/CO" or "INT ONLY" to the Automatic Answer Mode only when necessary.
- If you are using the "INT/CO" or "INT ONLY" setting in the Automatic Answer Mode and you take off the headset, please pull the the headset jack out.



- To select the vibration mode**
Press the Volume Control button until "VIBRATION CALL" is displayed. This button also changes the ringer volume which is indicated by the number of asterisks on the display.
- If the PS is on the charger**, just lift up the PS (Quick Answering).
- If a headset is connected to the PS**, you can select to answer a call without lifting your PS (Automatic Answer Mode).



Customising Your PS

- 5.4.2 PS Programming – To change the initial settings
 - Quick Answering Mode Set**
Select to answer calls by just lifting the ringing PS off the charger.
 - Automatic Answer Mode Set**
Select the answering mode when using the headset.

5.3.3 Redial

This is convenient when calling the same external party again.

- Redialling the last number you dialled
- Redialling one of the last five outside phone numbers you dialled

◆◆ Redialling the last number you dialled (Last Number Redial)

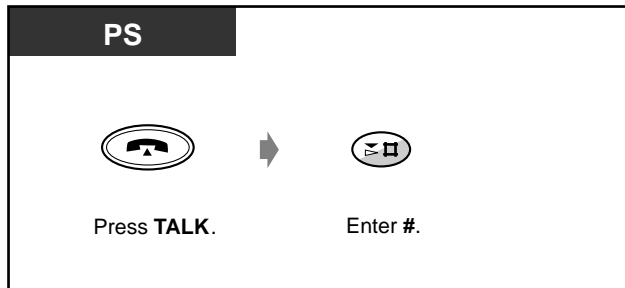

◆◆ Redialling one of the last five outside phone numbers you dialled (Outgoing Call Log)

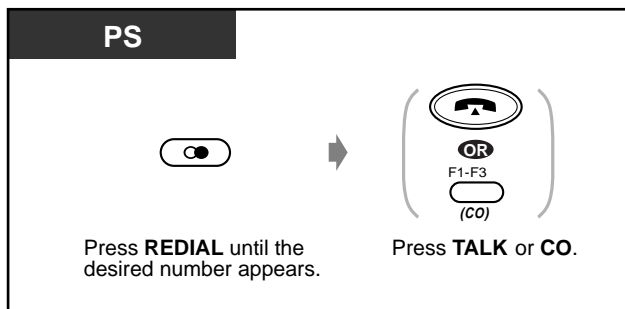

- To search the desired log number, press the Next or Previous button after pressing the REDIAL button.

◆ To clear all of the numbers in the call log

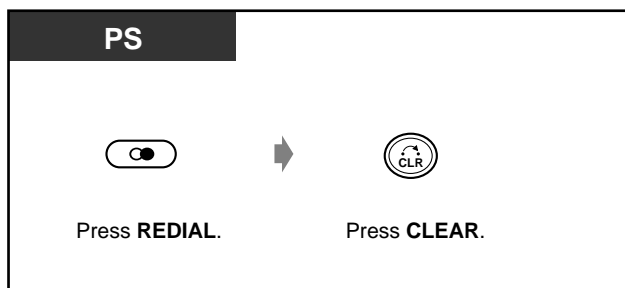

5.3.4 Holding a Call

- Holding
- Denying other people the possibility of retrieving your held calls



- If a call is not retrieved within a specified time, you will hear an alarm as a reminder.
- If a call is not retrieved within thirty minutes, it is automatically disconnected.

◆◆ Holding (regular)

PS

During a conversation

Press **HOLD**.

◆ To retrieve a call

PS

- **At the holding extension**

Press flashing **CO** or **INTERCOM**. Talk.
- **For an outside call from another extension**

Press flashing **CO** or dial **53** and **held line number** (01-54). C.Tone Talk.
- **For an intercom call from another extension**

Dial **51**. Enter **holding extension number**. C.Tone Talk.



- The CO or INTERCOM button light shows the current status as follows:
 - Flashing green:** Your held call
 - Flashing red:** Another extension's held call
- You can hold either an intercom call or an outside call at one time.
- To hold multiple calls,** use the "Call Park" feature.

◆◆ Denying other people the possibility of retrieving your held calls (Exclusive Call Hold)

Only the held extension can retrieve the call.

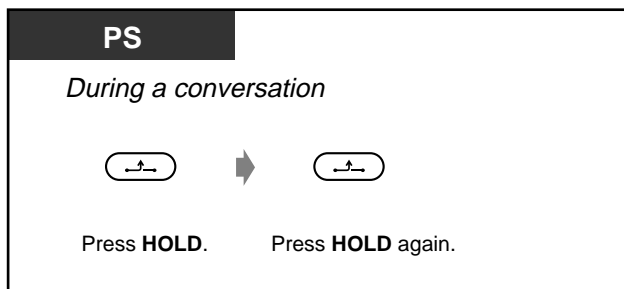

◆ To retrieve a call

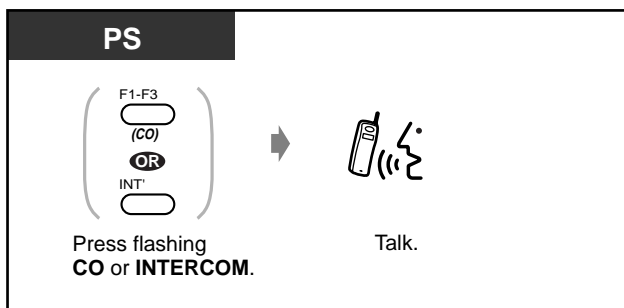

- The CO or INTERCOM button light shows the current status as follows:
 - Flashing green:** Your held call
 - Flashing red:** Another extension's held call
- You can hold either an intercom call or an outside call at one time.

5.3.5 Transferring a Call

— Transferring to an extension

— Transferring to an external party

◆◆ Transferring to an extension

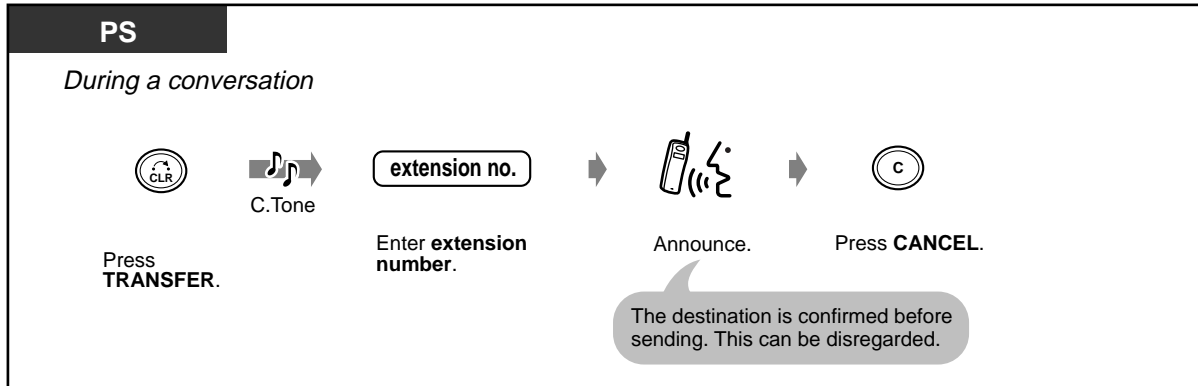

◆◆ Transferring to an external party

Some extensions may be restricted from performing this function.

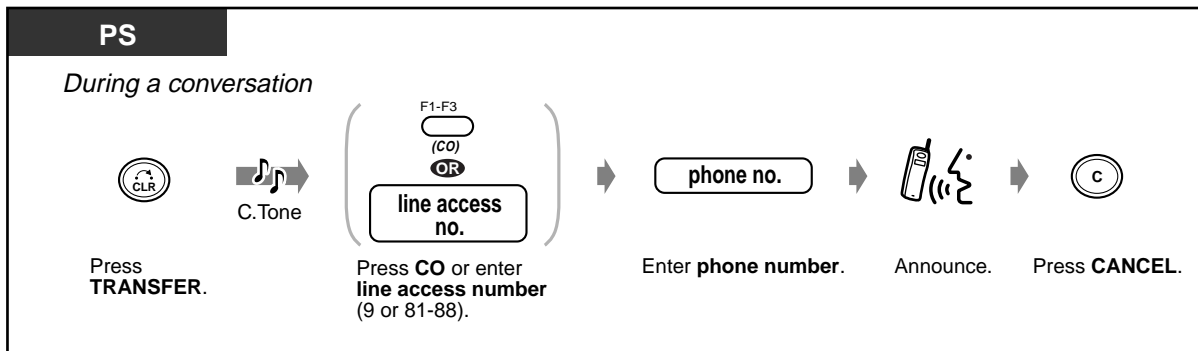

- **To return to the held call before the destination answers**, press the TRANSFER button or corresponding CO or the INTERCOM button.
- **To return to the conversation after completing the transfer to an external party**, press the corresponding CO button.
- **If you hear an alert tone**, the destination extension did not answer the call. Answer the call.

5.3.6 Using the Call Directories

- Storing the names and numbers
- Making calls using the Call Directories
- Entering characters

You can store names and/or phone numbers in the directories.

A stored number is dialled out by selecting a name or phone number in a directory.

There are four types of directory features, including one PS directory and three PBX directories.

PS Dialling Directory:

You can store up to 100 private names and phone numbers of outside parties. All directory items are stored in alphabetical order.

PBX System Speed Dialling Directory:

You can make a call via the system by selecting system-assigned names and phone numbers (500 max.).

PBX Extension Dialling Directory:

You can make a call via the system by selecting system-assigned extension names.

PBX Station Speed Dialling Directory:

You can make a call via the system by selecting privately assigned names and phone numbers (10 max.).

◆◆ Storing the names and numbers

You can store, edit or delete the PS Dialling Directory or PBX Station Speed Dialling Directory items on your PS. There are five displays for directory entry/edition/deletion as shown below.

Display sequence in “MODIFY BOOK” display

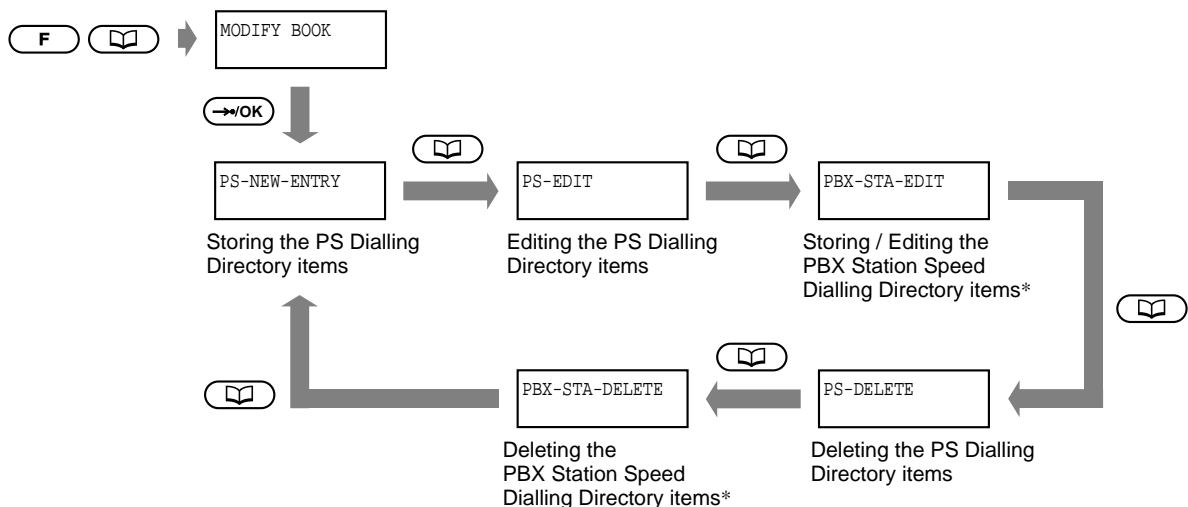

- It is not possible to edit items in the PBX System Speed Dialling or PBX Extension Dialling Directories.
- * Only displayed when registered to a Panasonic Digital Super Hybrid System. It is not displayed when out of range.

◆ To store a PS Dialling Directory item

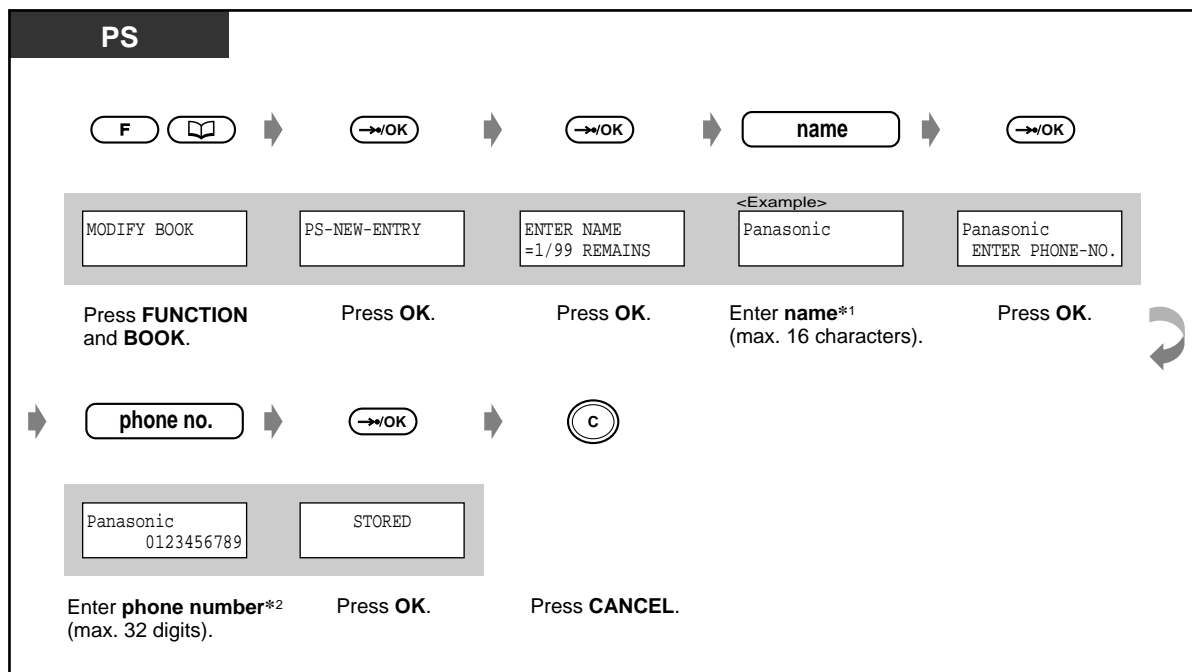

• To store a phone number first and then a name:



- To store a phone number only, skip the step for entering name.
- *1 To enter characters, see page 190.
- *2 The line access number is not required.

◆ To edit a PS Dialling Directory item

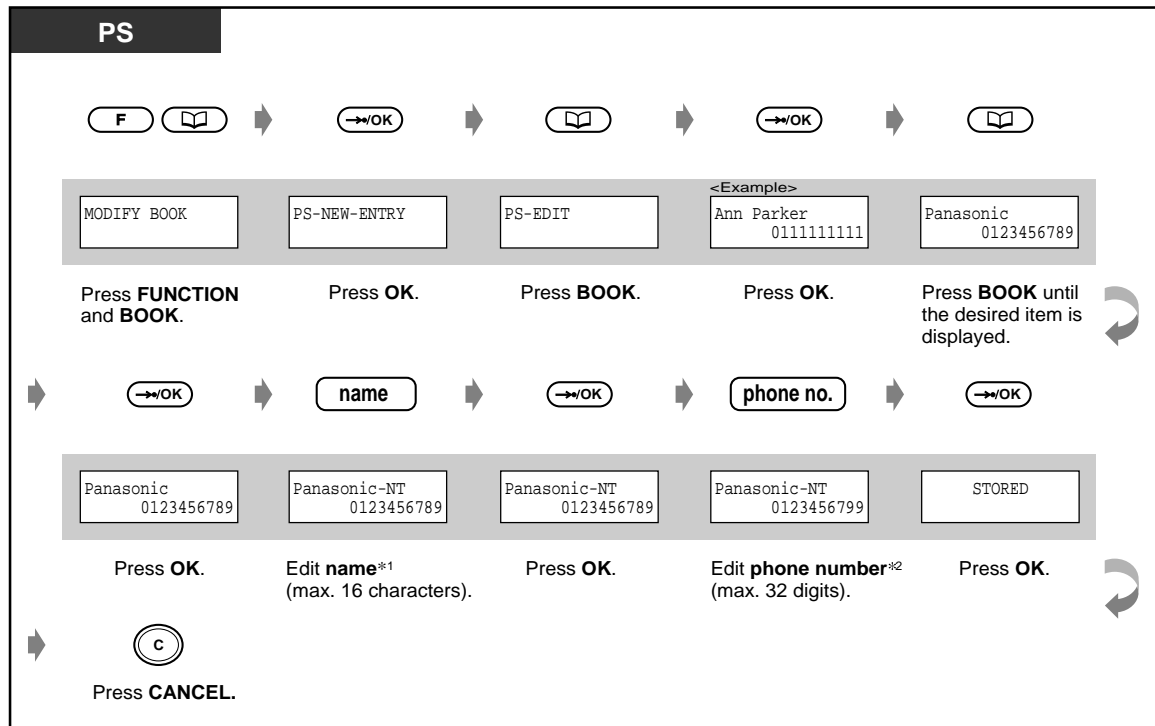

- *1 To enter characters, see page 190.
- *2 To change the number, press the CLEAR button to clear a digit from the left, and enter the number again.
To move the cursor on the number, use # (to the left) or * (to the right) button.

◆ To store / edit a PBX Station Speed Dialling Directory item

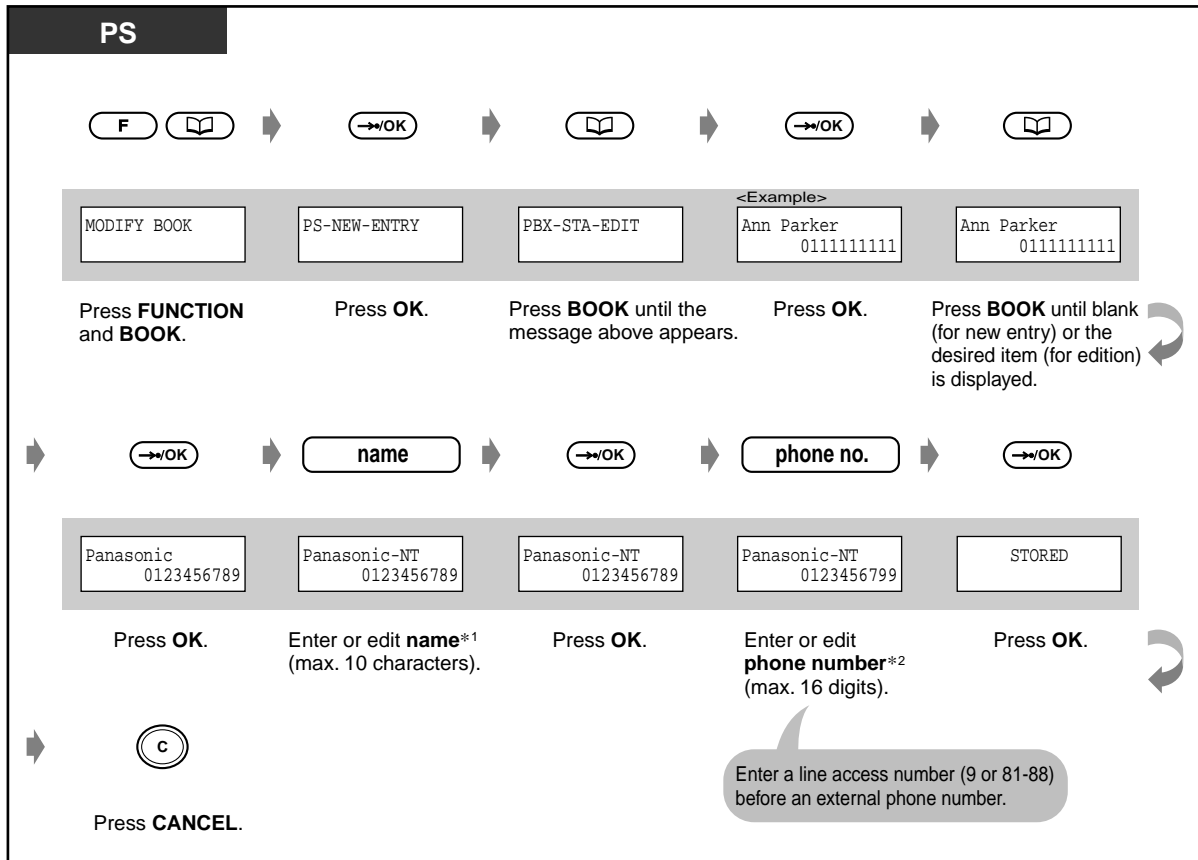

- *1 To enter characters, see page 190.
- *2 To change the number, press the CLEAR button to clear a digit from the left, and enter the number again.
To move the cursor on the number, press the # (to the left) or * (to the right) button.

◆ To delete a PS Dialling / PBX Station Speed Dialling Directory item

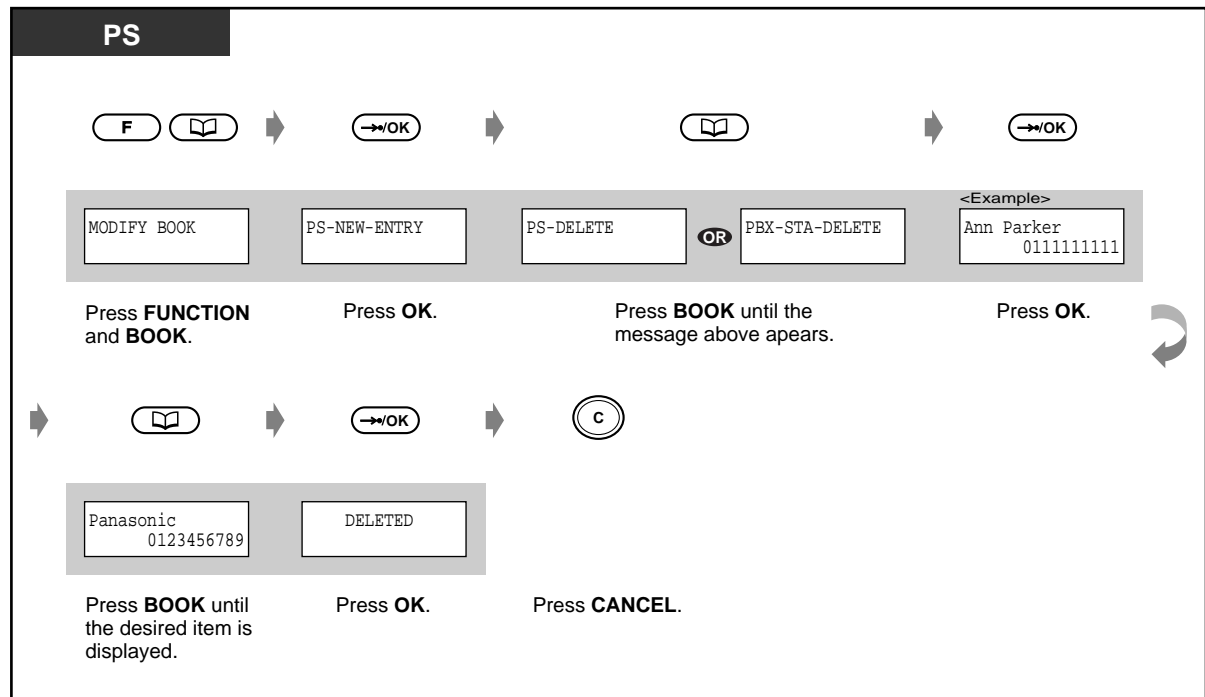

◆◆ Making calls using the Call Directories

There are four displays for directory dialling as shown below.

Display sequence for Call Directory dialling

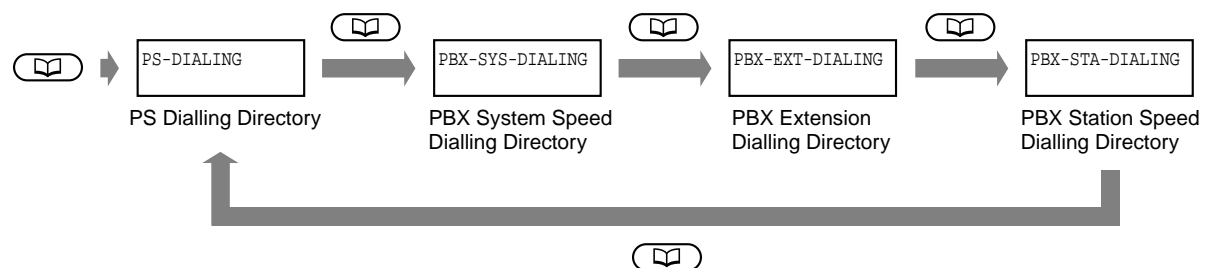

- These displays will not appear when registered to a non-Panasonic Digital Super Hybrid System or when out of range. In this case, the directory item appears after pressing the BOOK button.
- **You can transfer a call to a number stored in the directory.** In this case, press the TRANSFER button during a conversation and then dial by selecting the directory item.

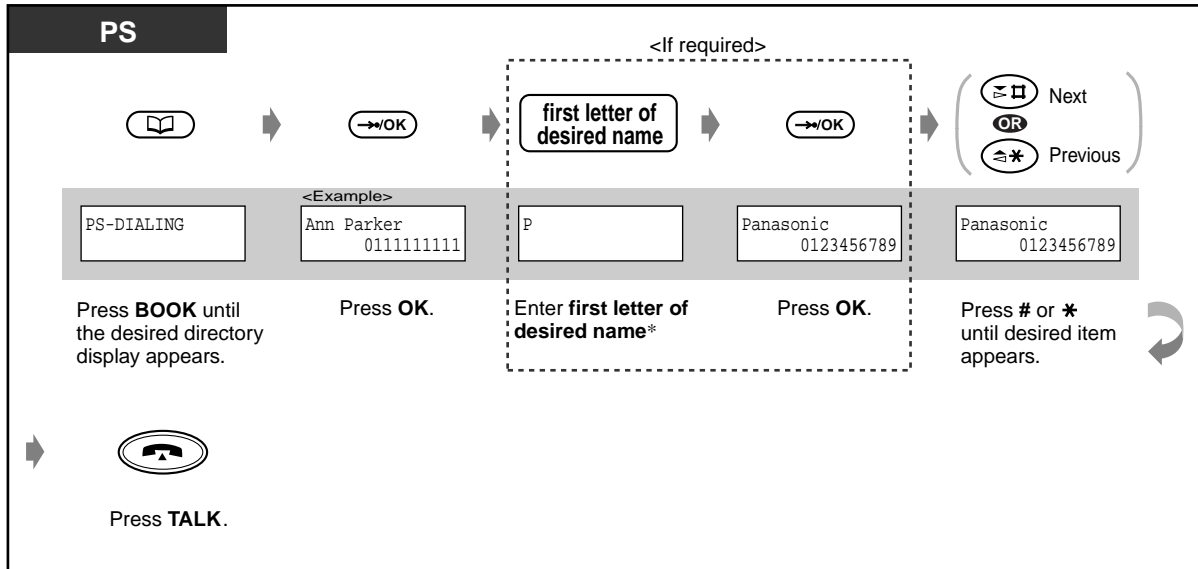

- * To enter characters, see page 190.
- You can lock the Call Directories to prevent other people from seeing the directory display. When locked, "DIRECTORY LOCK" will be displayed after pressing the BOOK button.

Customising Your PS

- 5.4.2 PS Programming – To change the initial settings
Directory Lock Control
Lock or unlock the Call Directories.

◆◆ Entering characters

When storing a name or message, enter the characters as follows. The table below shows you the characters available for each key. You can enter letters by pressing the alphanumeric keys on your telephone.
Example: Key 2 can enter A, a, B, b, C or c.

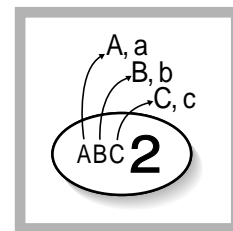

- To erase the each letter from the right, press the CLEAR button.
- To move the cursor, press the # (to the left) or * (to the right) button.

Combination Table

Keys	Display sequence by pressing the key
1	Ä ä Ö ö Ü ü 1
2	A a B b C c 2
3	D d E e F f 3
4	G g H h I i 4
5	J j K k L l 5
6	M m N n O o 6
7	P p Q q R r S s 7
8	T t U u V v 8
9	W w X x Y y Z z 9
0	(space) . : / - () 0
*	Moves the cursor to the left
#	Moves the cursor to the right

<Example> To enter "Ann,"

A	n	n
ABC 2	MNO 6 MNO 6 MNO 6 MNO 6	≅ □ MNO 6 MNO 6 MNO 6 MNO 6

5.3.7 Using Your PS in Parallel with the Wired Telephone (Super EXtra Device Ports [SXDP])

Your PS can be used in parallel with a proprietary wired (PT) or single line telephone (SLT). When in the SXDP mode, incoming calls to a wired telephone also reach the paired PS, while incoming calls to a PS only reach the PS. If one telephone is busy, you can make a call from the other telephone.

◆ **To set**

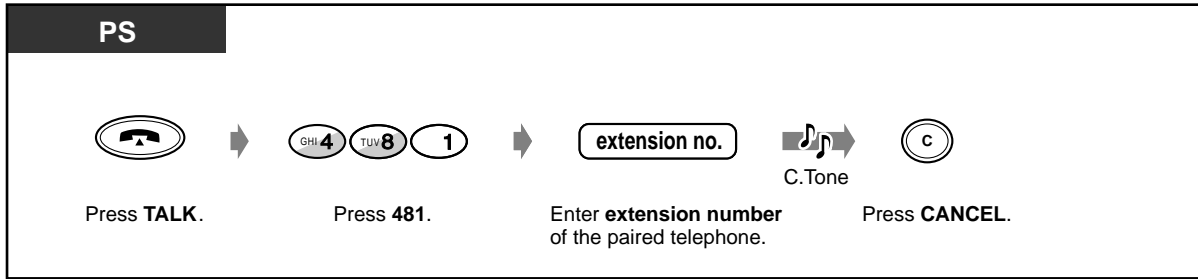

◆ **To cancel**

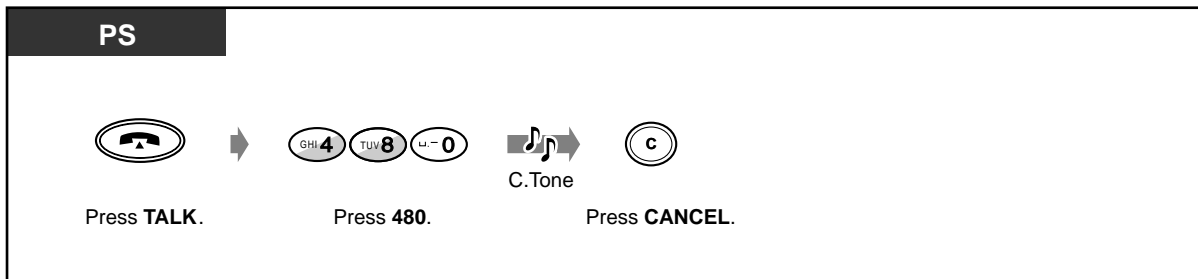

- The Outgoing Call Log memory can be used by both the PS and paired telephone.
- Some wired telephones are restricted to perform this feature.

5.3.8 Locking the Keypads

Incoming calls can be answered, but outgoing calls cannot be dialed.

◆ To lock / unlock

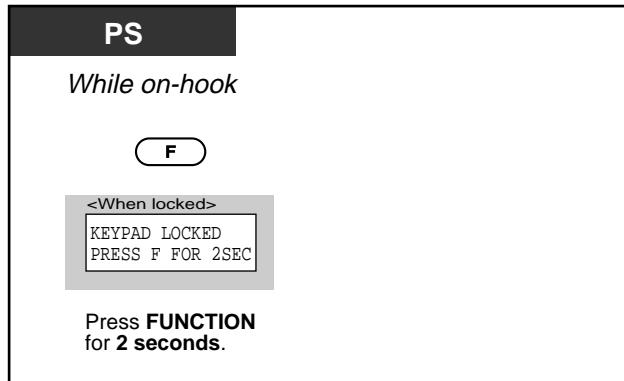

5.3.9 Selecting the Feature Button on the Display

The following buttons can be activated using display operations.

- PAUSE Button
- FWD/DND Button
- MESSAGE Button
- CONF (Conference) Button
- TONE Button

Display sequence in "KEY" display

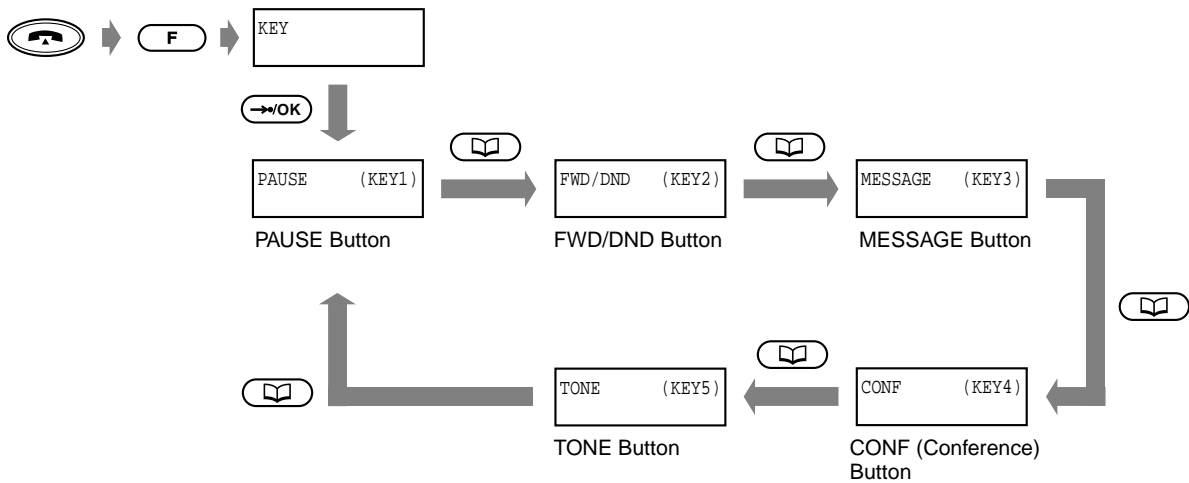



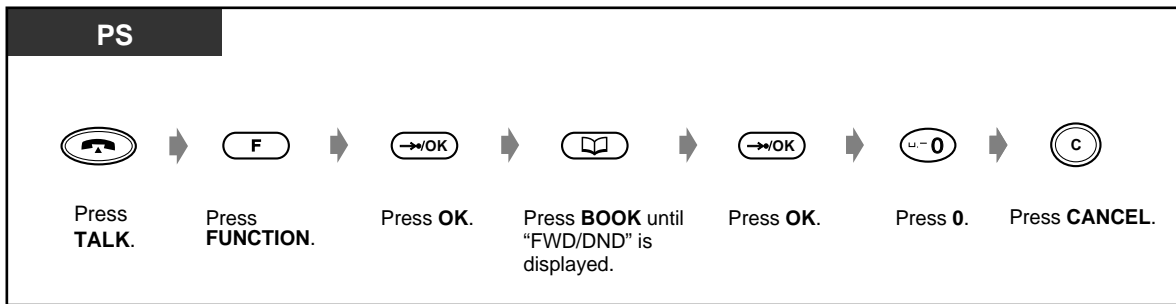



















<Example>
To cancel the Do Not Disturb feature











- These buttons can also be activated using a combination of buttons. For descriptions and button combinations, refer to 5.2.1 Before Operating the DECT Portable Station – Button Descriptions.

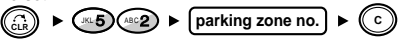

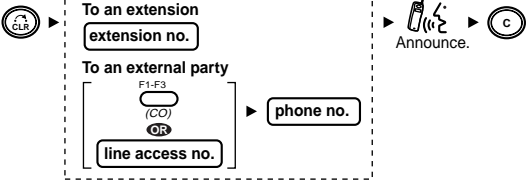
5.3.10 Other Operations

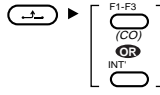
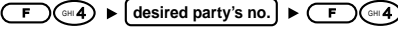
Most of the wired telephone features are also supported by a system with a DECT portable station (PS). For feature descriptions and details, refer to the respective features in Operation (Section 2).

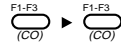
Desired Function	Operation
Making Calls	
Basic Calling To an operator (Operator Call)	 ► 
Easy Dialling With one touch button (One-Touch Dialling)	 ► 
Using numbers stored at your extension (Station Speed Dialling)	<p>To store a phone number</p>  ►  ►  ► station speed dial no. ► phone no. ►  ► 
Using numbers stored in the system (System Speed Dialling)	 ►  ► system speed dial no.
To a pre-set party by going off-hook (Pickup Dialling)	<p>To store a phone number</p>  ►  ►  ►  ► phone no. ►  ► 
Using a single digit number (Quick Dialling)	 ► quick dial no.
Redial Saving the number and redialling (Saved Number Redial)	<p>To store <i>During a conversation or while hearing a busy tone</i></p>  ► 
When the Dialed Line is Busy or There is No Answer Reserving a busy line (Automatic Callback Busy)	<p>To set <i>While hearing a busy tone</i></p>  ► 

Desired Function	Operation
Making Calls	
When the Dialed Line is Busy or There is No Answer Sending a call waiting tone (Busy Station Signalling [BSS])	While hearing a busy tone
Leaving a message waiting indication (Message Waiting)	To leave a message waiting indication when the called extension is busy or does not answer To leave / cancel a message waiting indication To call back To clear all message waiting indications
Joining an existing intercom call (Executive Busy Override)	While hearing a busy tone
Calling without Restrictions Using an account code (Account Code Entry)	
To an extension refusing the call (DND Override)	While hearing the DND tone
Changing the dialling mode (Pulse to Tone Conversion)	After the line is connected
Alternating the Calling Method (Alternate Calling – Ring / Voice)	Voice to ring calling or ring to voice calling
Receiving Calls	
Answering a Call Ringing at Another Telephone (Call Pickup)	
Answering a call via an External Speaker (Trunk Answer From Any Station [TAFAS])	

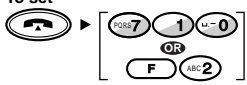
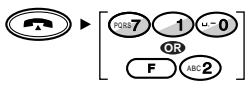
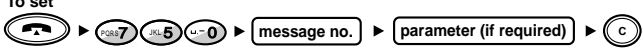
Desired Function	Operation
During a Conversation	
Holding a Call Holding in a system parking zone (Call Park)	<p>To set</p>  <p>To retrieving</p> 
Talking to Two Parties Alternately (Call Splitting)	<p><i>When talking to one party while the other party is on hold</i></p> <p>When either party is an outside party When both parties are extension parties</p> 
Transferring a Call	
Answering a Call Waiting	<p>To talk to the new caller by terminating the current call <i>While hearing a Call Waiting tone</i></p>  <p>To talk to the new caller by holding the current call <i>While hearing a Call Waiting tone</i></p> 
Three-party Conversation Adding a third party during a conversation (Conference)	
Leaving a conference	<p><i>When you are talking with two extension or one extension party and one external party</i></p>  <p><i>When you are talking with two external parties (Unattendant Conference)</i></p> 
Letting a third party join your call (Privacy Release)	<p>To join a third party to your current outside call <i>During a conversation</i></p>  <p>To leave</p>  <p>To talk to one party by disconnecting the other</p> 

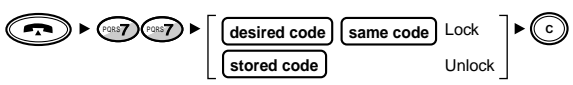
Desired Function	Operation
<p>Forwarding your Calls (Call Forwarding)</p>	<p style="text-align: center;">Before Leaving Your Desk</p> <p>To set</p>  <p style="text-align: center;">↓</p> <div style="border: 1px dashed black; padding: 5px;"> <p>All Calls</p> <p>ABC 2 ▶ [U-0 All ▶ extension no.]</p> <p> ▶ [1 Intercom]</p> <p> ▶ [ABC 2 Outside]</p> <p>Busy</p> <p>DEF 3 ▶ [U-0 All ▶ extension no.]</p> <p> ▶ [1 Intercom]</p> <p> ▶ [ABC 2 Outside]</p> <p>No answer</p> <p>GHI 4 ▶ [U-0 All ▶ extension no.]</p> <p> ▶ [1 Intercom]</p> <p> ▶ [ABC 2 Outside]</p> <p>Busy / No answer</p> <p>JKL 5 ▶ [U-0 All ▶ extension no.]</p> <p> ▶ [1 Intercom]</p> <p> ▶ [ABC 2 Outside]</p> <p>To Outside Line</p> <p>MNO 6 ▶ [U-0 All ▶ line access no. ▶ phone no. ▶ ☒]</p> <p> ▶ [1 Intercom]</p> <p> ▶ [ABC 2 Outside]</p> <p>Follow Me</p> <p>PPS 7 ▶ your extension no.</p> </div> <p style="text-align: right;">▶ (C)</p> <p>To cancel</p>  <p style="text-align: center;">↓</p> <div style="border: 1px dashed black; padding: 5px;"> <p>At the original extension</p> <p>U-0</p> <p>At the destination extension</p> <p>TTT 8 ▶ your extension no.</p> </div> <p style="text-align: right;">▶ (C)</p>
<p>Showing an Absent Message on the Caller's Telephone Display (Absent Message Capability)</p>	<p>To set</p>  <p>To cancel</p> 
<p>Preventing Other People from Using Your Telephone (Electronic Station Lockout)</p>	

Desired Function	Operation
Making / Answering an Announcement	
<p>Paging</p>	<p>All</p> <p>Announce.</p> <p>External</p> <p>Announce.</p> <p>Group</p> <p>Announce.</p>
<p>Paging a Person and Transferring a Call</p>	<p>Through a speaker and telephones</p> <p>Announce.</p> <p>Through a speaker</p> <p>Announce.</p> <p>Through the telephones of a particular extension group</p> <p>Announce.</p>
<p>Answering a Paged Announcement</p>	
Setting the Telephone According to Your Needs	
<p>Setting the Alarm (Timed Reminder)</p>	<p>To set</p> <p>To cancel</p> <p>To view the setting</p> <p>To stop or answer the ringback</p> <p>any key</p>
<p>Refusing Incoming Calls (Do Not Disturb [DND])</p>	
<p>Receiving a Call Waiting (Call Waiting)</p>	<p>To set / cancel</p>
<p>Displaying Your Number on the Called Party and Calling Party's Telephone (Calling / Connected Line Identification Presentation [CLIP / COLP])</p>	<p>To show an identification number</p>
<p>Denying Other People the Possibility of Picking up Your Calls (Call Pickup Deny)</p>	

Desired Function	Operation
Setting the Telephone According to Your Needs	
Denying Other People the Possibility of Joining Your Conversation (Executive Busy Override Deny)	
Protecting Your Line against Indication Tones (Data Line Security)	
Clearing the Feature Settings at Your Extension (Station Programme Clear)	
Using User-supplied Equipment	
If a Doorphone / Door Opener is Connected To call the doorphone Opening the door	To call the doorphone From a specified extension From any extension while talking to the doorphone
If a Host PBX is Connected Accessing external services (External Feature Access)	
If a Voice Processing System is Connected Voice mail integration	To forwarding your calls to a mailbox Transferring calls F1-F3 To listen to a stored message
Recording a conversation (Two-Way Recording)	To record into your mailbox / To stop recording F1-F3 To record into another mailbox F1-F3 To stop recording into another mailbox F1-F3

5.4 Customising Your PS

5.4.1 Programming Information

You can customise your telephone functions with your DECT portable station (PS).

PS Programming:

You can change the initial settings according to your needs.

PBX Programming:

You can enter into the proprietary wired telephone (PT) programming mode (Station Programming) and programme several items for your PS.

There are three displays for programming as shown below.

Display sequence in “PROGRAMMING” display

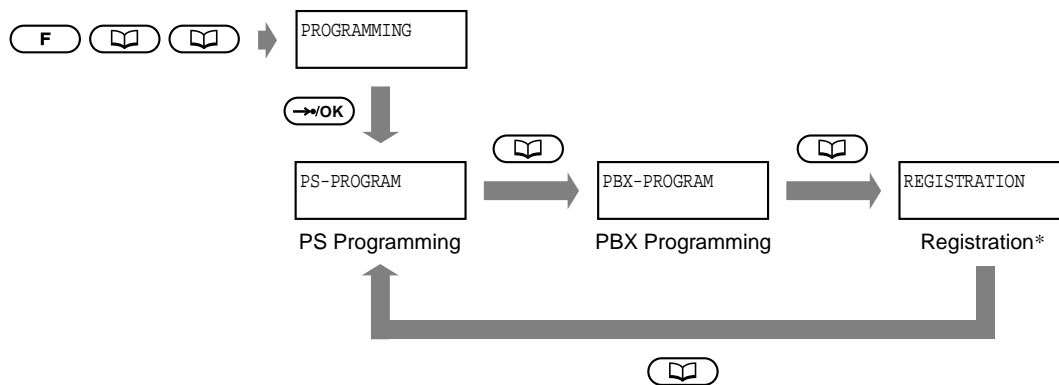

* This display is used for PS registration and not displayed if the DECT System Lock is set. For details, consult your dealer.

5.4.2 PS Programming

You may be required to enter a **PS Programming password** or a **DECT System Lock password** when entering the PS Programming mode.

Depending on the password, the number of possible programming items changes for PS security reasons. There are three password levels.

Level 0: A password is not required.

Level 1: A PS Programming password is required.

Level 2: A System Lock password is required.

After selecting the PS programming display, "ENTER PASSWORD" may be displayed.

If not displayed, no password is required.

The combinations of the passwords are as shown below.

If DECT System Lock password is:	DISABLE	DISABLE	ENABLE	ENABLE
If PS Programming password is:	DISABLE	ENABLE	DISABLE	ENABLE
System Lock password	Not required.	Not required.	Level 0 – 2 are possible.	Level 0 – 2 are possible.
PS Programming password	Not required.	Level 0 – 2 are possible.	Not required.	Level 0 – 1 are possible.
No password or If incorrect password	Level 0 – 2 are possible.	Level 0 is possible.	Level 0 – 1 are possible.	Level 0 is possible.

◆◆ To set the PS Programming / DECT System Lock password

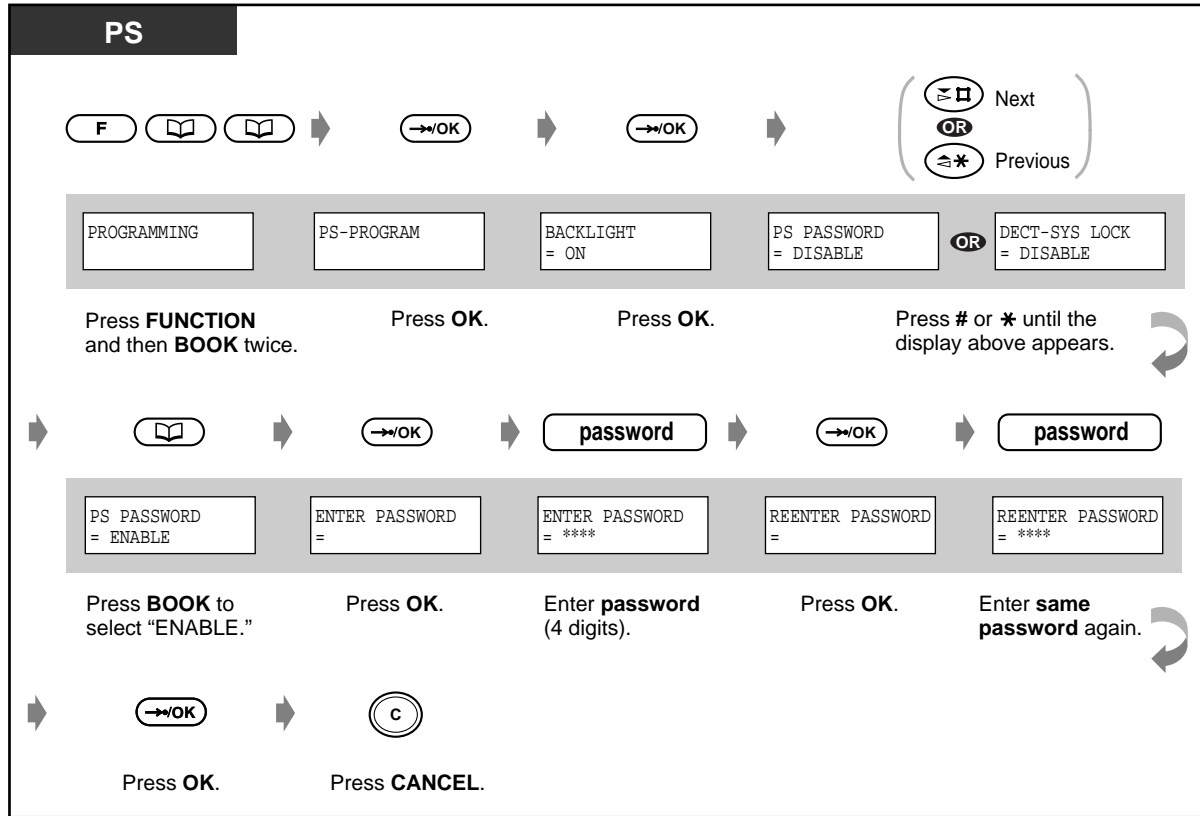

◆◆ To cancel the PS Programming / DECT System Lock password

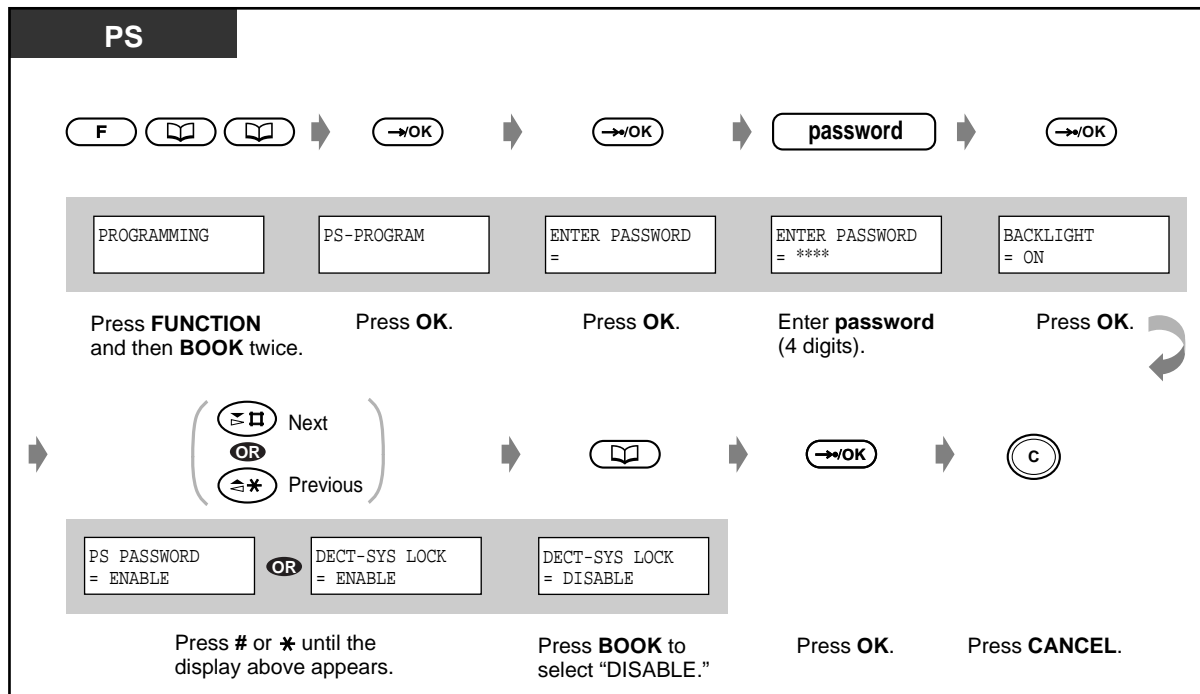

◆◆ To change the initial settings

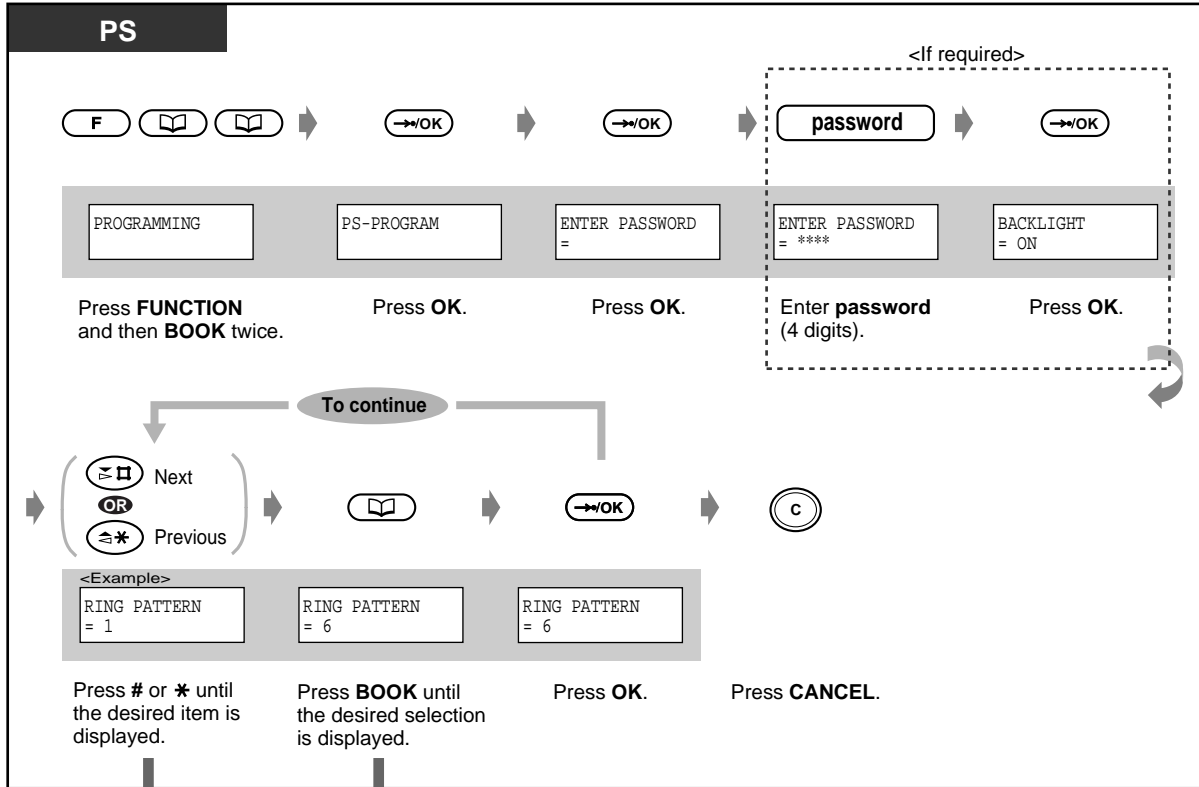



Display	Item	Selection	Level
BACKLIGHT = ON	Do you prefer the keypad backlight? (Keypad Backlight Mode Set)	<input type="checkbox"/> No (OFF) <input checked="" type="checkbox"/> Yes (ON)	0
KEY TONE = ON	Do you prefer to hear the key tone (except during PBX Programming mode)? (Key Tone Set)	<input type="checkbox"/> No (OFF) <input checked="" type="checkbox"/> Yes (ON)	0
RING PATTERN = 1	Which ringer pattern do you prefer in 6 patterns? (Ringer Pattern Selection)	<input type="checkbox"/> Ringer pattern no. <input type="text"/> <input checked="" type="checkbox"/> Ringer pattern 1	0
VIBRATION & RING = OFF	How do you receive a call? *1 (Vibration and Ring Type Selection)	<input type="checkbox"/> Ring and vibrate at the same time (RING & VIB) <input type="checkbox"/> Vibrate for 9 seconds then ring (VIB→RING) <input checked="" type="checkbox"/> Not use the vibration and ring mode (OFF)	0

Display	Item	Selection	Level
LANGUAGE = AUTO	Do you prefer to change the display language? (Display Language Selection)	<input type="checkbox"/> English <input type="checkbox"/> German <input type="checkbox"/> French <input type="checkbox"/> Italian <input type="checkbox"/> Spanish <input type="checkbox"/> Dutch <input checked="" type="checkbox"/> Auto (English)*2	0
DIRECTORY LOCK = OFF	Do you lock / unlock the Call Directories? (Directory Lock Control)	<input type="checkbox"/> Lock (ON) <input checked="" type="checkbox"/> Unlock (OFF)	1
QUICK ANSWER = ON	Do you prefer to answer an incoming call by just lifting your ringing PS off the Charger? (Quick Answering Mode Set)	<input type="checkbox"/> No (OFF) <input checked="" type="checkbox"/> Yes (ON)	0
AUTO ANSWER = OFF	Do you prefer to answer a call without lifting your PS using the headset? (Automatic Answer Mode Set)	<input checked="" type="checkbox"/> No (OFF) <input type="checkbox"/> Answer all calls. (INT/CO) <input type="checkbox"/> Answer only intercom calls. (INT ONLY)	0
AUTO ANS DELAY = 1RING	Select the number of rings before answering a call automatically when using the headset.*3 (Automatic Answer Delay Selection)	<input type="checkbox"/> [] ringers <input checked="" type="checkbox"/> 1 ring	0
ACCESS DECT-SYS = DECT-SYS1	Do you prefer to change the DECT system (1 through 4)?*4 (DECT System Selection)	<input type="checkbox"/> DECT System no. [] <input type="checkbox"/> AUTO (All connected terminals) <input checked="" type="checkbox"/> Your registered DECT system no.	2
STANDBY DISPLAY = OFF	Which standby display do you prefer?*5 (Standby Display Selection)	<input type="checkbox"/> Extension no. (EXT) <input type="checkbox"/> DECT system no. (DECT-SYS-NO.) <input type="checkbox"/> DECT system and extension no. (DECT-SYS-NO.&EXT) <input checked="" type="checkbox"/> None of these (OFF)	0

Display	Item	Selection	Level
DATE/TIME DISPLY = TIME	Which display do you prefer in the Standby mode? ^{*5} (Date / Time Display Selection)	<input type="checkbox"/> Date (DATE) <input checked="" type="checkbox"/> Date and time (TIME)	0
MEMORY CLEAR	<p>The following settings will be returned to their default settings</p> <ul style="list-style-type: none"> – Call log numbers^{*6} – Ringer volume – Receiver volume – PS Programming items <p>(except: Selecting the DECT System; Cancelling the PS Registration; Setting the PS Programming Password; Setting the DECT System Lock)</p> <p>Press the OK button after the display on the left appears. (Memory Clear)</p>		1
CANCEL DECT-SYS = DECT-SYS1	After cancelling the PS registration in System Programming, cancel again by pressing the OK button after the display on the left appears. For details, consult your dealer. (PS Registration Cancellation)		2
GUIDANCE = OFF	Do you prefer the Guidance menu to help you operate your PS? ^{*7} (Guidance Menu Set)	<input type="checkbox"/> Yes (ON) <input checked="" type="checkbox"/> No (OFF)	0
PS PASSWORD = DISABLE	Do you prefer to use the PS Programming password? (PS Programming Password Set)	<input type="checkbox"/> Yes (ENABLE) <input checked="" type="checkbox"/> No (DISABLE)	1
DECT-SYS LOCK = DISABLE	Do you prefer to use the DECT System Lock password? (DECT System Lock Password Set)	<input type="checkbox"/> Yes (ENABLE) <input checked="" type="checkbox"/> No (DISABLE)	2



- *₁ If you set the ringer volume off or vibration mode using the Volume Control button, the PS doesn't ring regardless of this setting.
- *₂ If you are connected to a Panasonic Digital Super Hybrid System while the default setting is still "AUTO," the display language will depend on the setting of the system.
- *₃ The display of this item is only displayed when "Automatic Answer Mode Set" is set to "INT/CO" or "INT ONLY."
- *₄ The display of this item is only displayed when more than two fixed terminals are connected.
- *₅ The display of this item is only displayed when your PS is registered to a Panasonic Digital Super Hybrid System and "〒" is displayed.
- *₆ Call log numbers are cleared only when your PS is registered to a system other than a Panasonic Digital Super Hybrid System.
- *₇ For the Guidance menu, some keys work differently from the normal use.

BOOK ()=NEXT OK ()=OK # ()=NEXT

* ()=PREV HOLD ()=BACK C ()=EXIT

5.4.3 PBX Programming

You can enter into the proprietary wired telephone (PT) programming mode and programme several items for your PS.

The available programmes are listed below.

Initial Settings

Customising the Buttons

Charge Fee Management

◆◆ Initial Settings

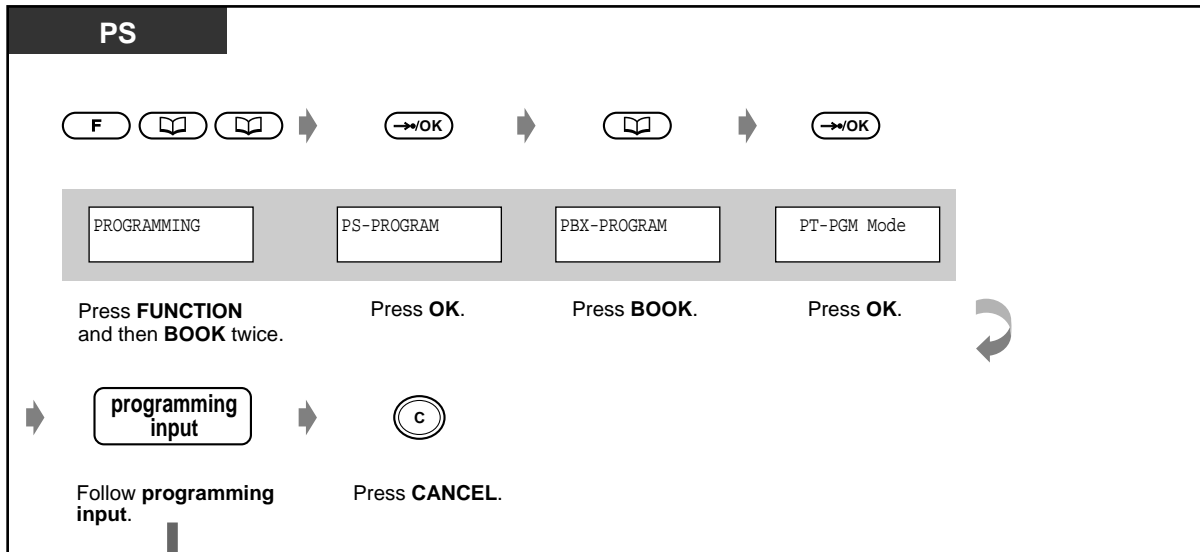

Item	Selection	Programming Input
Which line do you prefer to seize when you go off-hook to make calls? (Preferred Line Assignment – Outgoing)	<input type="checkbox"/> No line	1 1 →OK
	<input type="checkbox"/> An idle outside line	1 ABC 2 →OK
	<input type="checkbox"/> A pre-assigned outside line	1 DEF 3 Outside line no. (01–54) →OK
	<input checked="" type="checkbox"/> The Intercom line	1 INT' →OK
To clear the setting of the “Preferred Line Assignment – Outgoing”		≡ □ →OK
To check your extension number		MNO 6 ↵

◆◆ Customising the Buttons

You can change the flexible CO buttons to the following function buttons.

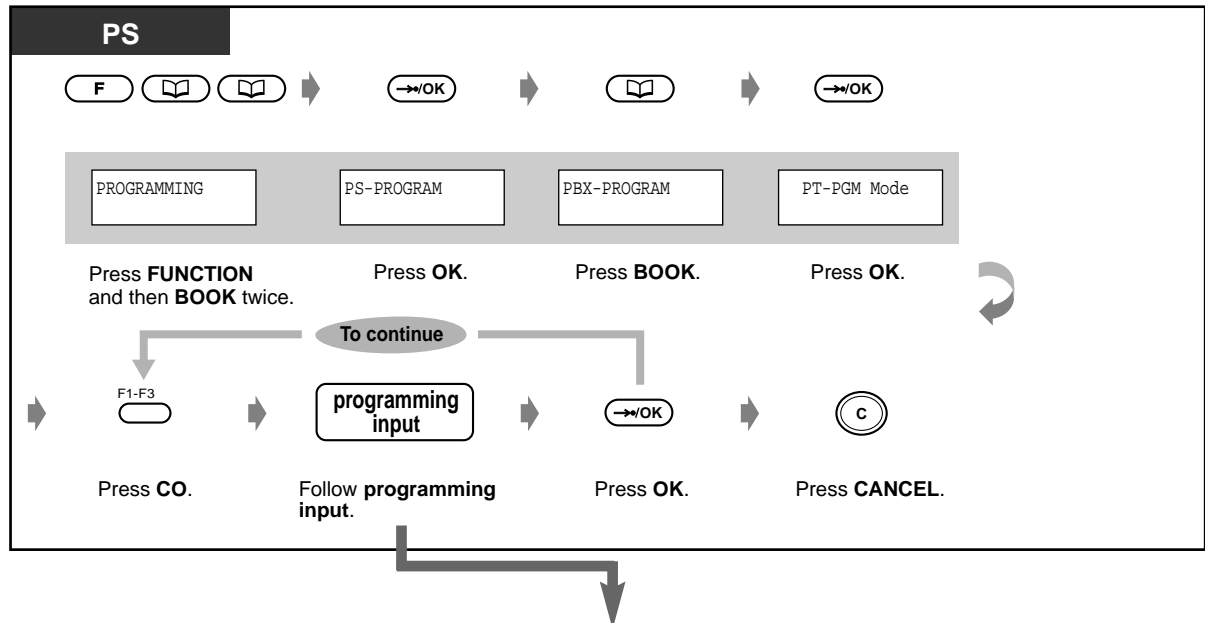

Button	Programming Input
Loop-CO	
Group-CO	Outside line group no. (1–8)
Single-CO	Outside line no. (01–54)
Direct Station Selection (DSS)	Extension no.
One-Touch Dialling	Desired no.*1 (max. 16 digits)
Message	
FWD/DND (Forward/Do Not Disturb)	
Save	
Account	
Conference	
Voice Mail Transfer*2	Voice mail extension no.
Two-Way Record*2	Voice mail extension no.
Two-Way Transfer*2	Voice mail extension no.



- *1 *#, "#", FLASH, PAUSE, SECRET (Intercom) and — (Conference) can also be stored.
 - If you do not want to display the stored number, press the SECRET (Intercom) button before and after the numbers you wish to conceal.
 - If you store an external party's number, you should first store a line access number (9, 81 to 88).
 - If you need to enter an account code, you can enter the specified account code before the line access number.

<Example>

49	1234	#	9	SECRET 123 4567
Account code feature no.	Account code	Account code delimiter	Automatic line access number	Phone number

- *2 These buttons are used for the voice mail integration feature.
- **To exit the mode at any time**, press the CANCEL button.

◆◆ Charge Fee Management

[pre-assigned extension only]

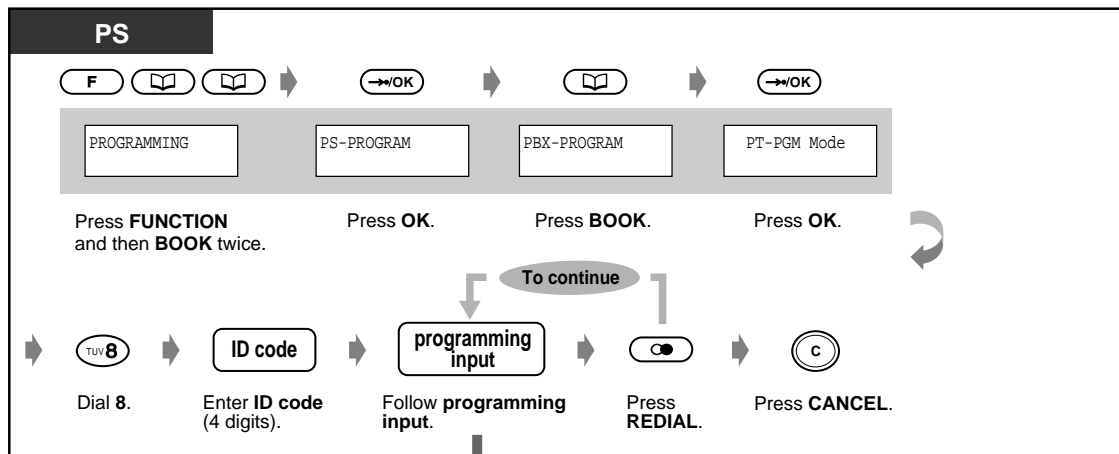

Item	Programming Input
Viewing each extension charge.	1 Extension no.
Clearing each extension charge.	1 Extension no.
Viewing each outside line charge.	2 Outside line no. (01-54)
Viewing the total charge.	3
Viewing each account code charge.	4 Account table no. (001-128)
Clearing each account code charge.	4 Account table no. (001-128)
Assigning a new rate.	5 New rate (1-8 digits)
Clearing all outside line and account code charges.	6 [Displays the last clearing date and time.]
Clearing all extension charges.	6 [Displays the last clearing date and time.]
Printing the total telephone charge (each outside line and account code charge), all extension charges or each extension charge by SMDR.	7 1 total telephone charge
	7 2 all extension charges
	7 3 Extension no. each extension charge
Assigning an account code.	8 Account table no. (001-128) New account code (max.10 digits)

Section 6

Appendix

This chapter provides the Troubleshooting, Feature Number List, Directory, Tone List, Specifications and the Quick Reference Card for a Single Line Telephone. Check the Troubleshooting before consulting your dealer.

6.1 Troubleshooting

6.1.1 Troubleshooting

◆◆ Troubleshooting for wired telephones

Problem	Remedy
The telephone does not work properly.	➔ Consult your dealer.
I cannot use the telephone.	<ul style="list-style-type: none"> • The telephone is locked. ➔ Unlock your telephone. (☞ 2.5.3 Preventing Other People from Using Your Telephone (Electronic Station Lockout), 3.1.1 Changing the Settings) • Your telephone is connected to an eXtra Device Port. ➔ System programming is required. Consult your dealer.
Some features do not work.	<ul style="list-style-type: none"> • System management may restrict certain features. ➔ Consult your manager. • The feature numbers have changed. ➔ Confirm the revised number and try again.
Even though following the manual instructions, none of the operations work when using a proprietary telephone.	<ul style="list-style-type: none"> • The Intercom line was not seized. The seized line, when going off-hook, was changed by personal setting. (☞ 4.1.2 Initial Settings) ➔ In the manual, going off-hook means an Intercom line is seized. If the setting has been changed, press the INTERCOM button after going off-hook and follow the instructions.
The paralleled single line telephones do not ring.	<ul style="list-style-type: none"> • This is the default setting. ➔ Change the setting to ring. (☞ 2.7.10 Setting the Parallel Connected Telephone Ringer (Paralleled Telephone))
The telephone does not work using the personal settings or with other settings. (One-touch dialling, forwarding destination, etc.)	<ul style="list-style-type: none"> • The extension line has been changed. The previous telephone's settings have not be cleared. ➔ Clear the settings and then programme your desired settings again. (☞ 2.7.11 Clearing the Feature Settings at Your Extension (Station Programme Clear), 4.1.2 Initial Settings, 4.1.3 Customising the Buttons)
My proprietary telephone does not have a function button.	<ul style="list-style-type: none"> • Some models do not have the function button. ➔ Change a flexible button to the desired button. (☞ 4.1.3 Customising the Buttons) ➔ Enter the specified feature number instead of the function button. (☞ 2.1.1 Before Operating the Telephones)

Problem	Remedy
A reorder tone is audible or "Restricted" is displayed.	<ul style="list-style-type: none"> • The telephone is locked. <ul style="list-style-type: none"> ➔ Unlock your telephone. (☞ 2.5.3 Preventing Other People from Using Your Telephone (Electronic Station Lockout), 3.1.1 Changing the Settings) • Toll restriction is activated. <ul style="list-style-type: none"> ➔ Consult your manager or dealer. • An account code is required. (☞ 2.2.5 Calling without Restrictions, 4.1.4 Charge Fee Management [Pre-assigned extension only])
I cannot make an outside call using the One-Touch Dialling button or speed dialling.	<ul style="list-style-type: none"> • A line access number was not stored. <ul style="list-style-type: none"> ➔ A line access number is required for outside calls. (☞ 2.2.1 Basic Calling, Refer to "Storing the names and numbers for station speed dialling" in 2.9.4 Using the KX-T7433, KX-T7436 or KX-T7235, 4.1.3 Customising the Buttons)
I cannot remember the feature numbers.	<ul style="list-style-type: none"> ➔ Ask your dealer to change the feature numbers for easier use.
While talking to an outside party, the line is disconnected.	<ul style="list-style-type: none"> • The time limit has run out. (☞ 2.4.3 Transferring a Call 2.4.5 Three-party Conversation) <ul style="list-style-type: none"> ➔ Consult your dealer to extend the time, if necessary.
Redialling does not function.	<ul style="list-style-type: none"> • The stored number was more than 24 digits or an extension number. (☞ 2.2.3 Redial)
I cannot access computer services, banking-by-phone, etc.	<ul style="list-style-type: none"> • A tone signal is required. (☞ 2.2.5 Calling without Restrictions)
The personal computer and facsimile communication failed.	<ul style="list-style-type: none"> • An indication tone may have interrupted communication.(☞ 2.7.8 Protecting Your Line against Indication Tones (Data Line Security))
I do not want to show my identification number to the calling or called party's telephone.	<ul style="list-style-type: none"> ➔ Consult your manager or dealer.
I want to show my identification number to the calling or called party's telephone.	<ul style="list-style-type: none"> • (☞ 2.7.4 Displaying Your Number on the Called Party and Calling Party's Telephone (Calling / Connected Line Identification Presentation [CLIP / COLP]))
I cannot send a call waiting tone to the dialled extension.	<ul style="list-style-type: none"> • The other party has not set the Call Waiting feature. (☞ 2.2.4 When the Dialled Line is Busy or There is No Answer, 2.4.4 Answering a Call Waiting, 2.7.3 Receiving a Call Waiting (Call Waiting / Off-Hook Call Announcement [OHCA] / Whisper OHCA)) • The other party has set Data Line Security. (☞ 2.7.8 Protecting Your Line against Indication Tones (Data Line Security))
I forgot the lock code / Live Call Screening Password.	<ul style="list-style-type: none"> ➔ Ask the Operator to assist you. (☞ 3.1.1 Changing the Settings)

Problem	Remedy
The background music started suddenly.	<ul style="list-style-type: none"> ➔ Turn off the music. (☞ 2.7.7 Turning on the Background Music, 3.2.2 Turning on the External Background Music)
I do not want to display a number which is stored in memory.	<ul style="list-style-type: none"> ➔ Conceal the number. (☞ Refer to "Storing the names and numbers for station speed dialling" in 2.9.4 Using the KX-T7433, KX-T7436 or KX-T7235, 4.1.3 Customising the Buttons)
The display does not show the message described in the manual.	<ul style="list-style-type: none"> • The telephone is not a Panasonic proprietary telephone. <ul style="list-style-type: none"> ➔ This manual shows messages which appear only on Panasonic proprietary telephones (e.g. KX-T7436). (☞ 2.1.1 Before Operating the Telephones)
I want to confirm my extension number and jack number.	<ul style="list-style-type: none"> (☞ 4.2.1 Programming Information)
The date and time are not correct.	<ul style="list-style-type: none"> • Set the date and time by system programming. (☞ 4.2.2 Date and Time Set (000))
The display is not shown well.	<ul style="list-style-type: none"> • The lithium battery for memory back-up needs to be replaced. <ul style="list-style-type: none"> ➔ Consult your dealer.
I want to distinguish the tones.	<ul style="list-style-type: none"> (☞ 4.1.2 Initial Settings, 4.1.3 Customising the Buttons)
I hear a warning tone from the telephone.	<ul style="list-style-type: none"> • The handset was off-hook in an idle status for an extended period of time. <ul style="list-style-type: none"> ➔ Replace the handset.
The MESSAGE button light lit.	<ul style="list-style-type: none"> • Another extension left you a message waiting indication during you were on the phone or left your desk.

Problem	Remedy
<p>A Power Failure occurred.</p>	<p>When a power failure occurs...</p> <p>The system and Panasonic proprietary telephones stop all functions. Specific extensions are automatically connected straight to specific CO (outside) lines. This provides CO line conversations between the following extension and CO lines:</p> <p>KX-TD816 CO01 - Jack number 01 CO02 - Jack number 02 CO05 - Jack number 09 (not available for an ISDN line) CO06 - Jack number 10 (not available for an ISDN line)</p> <p>KX-TD1232 CO01 - Jack number 01 CO02 - Jack number 02 CO03 - Jack number 09 CO04 - Jack number 10 CO09 - Jack number 17 (not available for an ISDN line) CO10 - Jack number 18 (not available for an ISDN line)</p> <p>All intercom calls and features do not function.</p> <p>When turning the power back on... Your system restarts with the stored data automatically. Memory is protected by a pre-installed lithium battery. There is no memory loss except for Automatic Callback Busy (Reserving a busy line) and Held calls.</p>

◆◆ Troubleshooting for DECT Portable Station

Problem	Remedy
The PS does not work.	<ul style="list-style-type: none"> • The battery is empty. <ul style="list-style-type: none"> ➔ Charge the batteries fully. (☞ 5.2.1 Before Operating the DECT Portable Station Battery Charge) • The PS has been cancelled or the PS has not been registered. <ul style="list-style-type: none"> ➔ Consult your dealer.
The PS does not operate.	<ul style="list-style-type: none"> • The power switch is OFF. <ul style="list-style-type: none"> ➔ Turn it ON. (☞ 5.2.1 Before Operating the DECT Portable Station Button Descriptions)
The PS does not ring.	<ul style="list-style-type: none"> • Ringer volume is set to OFF or VIBRATION. <ul style="list-style-type: none"> ➔ Set to ring by pressing the Volume Control button. (☞ 5.2.1 Before Operating the DECT Portable Station Button Descriptions) • The PS is out of range or the Cell Station (CS) is busy. <ul style="list-style-type: none"> ➔ Move closer to the CS or try again later. • The radio channel is busy or a radio communication error occurred. <ul style="list-style-type: none"> ➔ Try again later.
You cannot dial.	<ul style="list-style-type: none"> • The number which you dialled is restricted by the system. <ul style="list-style-type: none"> ➔ Consult your dealer. • The key lock mode is set. <ul style="list-style-type: none"> ➔ To cancel the mode, press the Function for about 2 seconds. (☞ 5.3.8 Locking the Keypads) • The radio channel is busy or a radio communication error occurred. <ul style="list-style-type: none"> ➔ Try again later.
Static, sound cuts in/out, fades. Interference from other electrical units.	<ul style="list-style-type: none"> ➔ Set the PS and CS away from other electrical appliances. ➔ Move closer to the CS.
"CS Busy" is displayed.	<ul style="list-style-type: none"> • The radio channel is busy. <ul style="list-style-type: none"> ➔ Try again later.
"FAULT" is displayed.	<ul style="list-style-type: none"> ➔ Consult your dealer.

Problem	Remedy
"PS NO CONNECTED" is displayed.	<ul style="list-style-type: none"> • The power switch is set to OFF. <ul style="list-style-type: none"> ➔ Turn it ON. (☞ 5.2.1 Before Operating the DECT Portable Station Button Descriptions) • The PS is out of range. <ul style="list-style-type: none"> ➔ Move closer to the CS. • The radio channel is busy or a radio communication error occurred. <ul style="list-style-type: none"> ➔ Try again later.
"REGISTER UNIT" is displayed.	<ul style="list-style-type: none"> • The PS is not registered in the system. <ul style="list-style-type: none"> ➔ Consult your dealer.
"NO SERVICE" is displayed.	<ul style="list-style-type: none"> • The PS is out of range. <ul style="list-style-type: none"> ➔ Move closer to the CS.
You cannot store a phone number and name in the directory.	<ul style="list-style-type: none"> • Your entry exceeds the maximum digits or characters. • Do not pause for over 30 seconds while programming.
The alarm sounds after pressing the Redial button.	<ul style="list-style-type: none"> • A number is not saved in the Call Log.
"🔋" flashes or beeps tones sound every 5 seconds during a conversation.	<ul style="list-style-type: none"> • The battery is low. <ul style="list-style-type: none"> ➔ Charge the batteries fully. (☞ 5.2.1 Before Operating the DECT Portable Station Battery Charge)
You charged the batteries fully, but "🔋" flashes.	<ul style="list-style-type: none"> ➔ Clean the charge contacts and charge again. ➔ It is time to change the batteries. Please purchase new batteries.
The PS stops working during operation.	<ul style="list-style-type: none"> ➔ Turn the power switch OFF and ON. Then try again. (☞ 5.2.1 Before Operating the DECT Portable Station Button Descriptions) ➔ Re-insert the battery and try again. (☞ 5.2.1 Before Operating the DECT Portable Station Battery Charge)
Handover does not work.	<ul style="list-style-type: none"> • You moved to a busy CS or are out of range. • You moved while not having a conversation (e.g., while hearing a busy tone). • The radio channel is busy or a radio communication error occurred.
The display does not show a strong radio signal "📶" even though you are near the CS.	<ul style="list-style-type: none"> • Normally, the PS user can make a call even with a "📶" status. In this case, the current linked CS is still connected even though another CS is closer.
The alarm sounds during a conversation while receiving a weak radio signal "📶".	<ul style="list-style-type: none"> • The radio signal is weak. <ul style="list-style-type: none"> ➔ Move closer to the CS.

6.2 Feature Number List

6.2.1 Feature Number List

Numbers listed below are the default settings. There are flexible feature numbers and fixed feature numbers. If you change the flexible feature numbers, fill in your assigned numbers in the list for future reference.

Feature	Default	Assigned no.	Additional digits
Calling the operator	0		
Automatic line access number / ARS	9		
Outside line number	8		1-8
Calling a pre-set party by going off-hook / cancelling / storing	74		1 / 0 / 2+phone no.+#
Calling using the number stored at your extension Storing the numbers	3* 30		0-9 [0-9]+phone no.+#
Calling using the number stored in the system	*		000-499
Redialling the last phone number you dialled	#		
Reserving a busy line	6	Fixed	
Sending a call waiting tone	1	Fixed	
Leaving a message waiting indication / cancelling /calling back / clearing a received indication	70		1+ext. no. / 0+ext. no. / 2 / 0+your ext.no.
Joining an existing call	2	Fixed	
16th incoming call log is stored / disregarded	56		1 / 0
Picking up a call for someone else – outside call – group – direct	4* 40 41		ext. no.
Holding or retrieving a call	50		
Retrieving from another extension – outside call – intercom call	53 51		01-54 ext. no.
Holding in a system parking zone or retrieving	52		0-9
Paging or transferring and paging – all devices / all extensions /group – external speaker	33 32		* / 0 / 1-8 1-4
Answering a paged announcement or an incoming call through the speaker	42		1-4
Answering the paged announcement through telephones	43		

Feature	Default	Assigned no.	Additional digits
Receiving or refusing a call waiting tone or voice no tone / tone / OHCA / whisper OHCA	731		0 / 1 / 2 / 3
Accessing external services	6		
Forwarding your call – All calls / Busy / No answer / Busy, No answer – to an external party – cancelling – Follow Me / cancelling	710 ↓		[2 / 3 / 4 / 5]+[0-2]+ ext. no. 6+[0-2]+line access no.+phone no.+# 0 [7 / 8]+your ext. no.
Refusing all calls (DND) / cancelling	710		1 / 0
Showing a message to the caller / cancelling	750		[1-9]+(parameter) / 0
Joining the call receiving group / leaving	45		1 / 0
Conference	3	Fixed	
Calling with account codes	49		code+[# or 99]
Temporary tone dialling	*#	Fixed	
Dialling a DND extension	1	Fixed	
Setting the alarm / cancelling / viewing	76		1+time+ [0 (AM) / 1 (PM)]+ [0 (once) / 1 (daily)] / 0 / 2
Displaying your number on the called / calling party's telephone – showing a number assigned for an outside line / your extension	711		1 / 2
Denying other people the possibility of – seeing your call logs / Allowing – using your telephone / Allowing – picking up your calls / Allowing – joining your conversation / Allowing	57 77 720 733		3 digits code twice / stored code 3 digits code twice / stored code 1 / 0 1 / 0
Turning on / off the background music	1	Fixed	
Refusing / receiving the indication tones	730		1 / 0
Day / Night service confirmation	#	Fixed	
Switching the display - month, day, time / month, day, year, day of the week	*	Fixed	
Paralleled telephones ring / do not ring	39		1 / 0
Switching the calling method (Ring / Voice)	*	Fixed	
Cancelling the feature settings	790		

Feature	Default	Assigned no.	Additional digits
Calling the doorphone	31		1-4
Opening the door from a specified phone from any extension while talking	55 5	Fixed	1-4
* Setting the Live Call Screening password / cancelling	799		3 digits code twice / stored code
* Hotel use features – Setting the alarm for other extensions / cancelling / viewing – Changing the room status	7* 736		1+ext. no.+time+ [0 (AM) / 1(PM)]+ [0 (once) / 1 (daily)] 0+ext. no. / 2+ext. no.
* Turning on / off the background music	35		
* Switching the Day / Night service – to day / to night	78		0 / 1
* Recording an outgoing message / playing back	36		[1 / 2]+OGM no.

* : Operator only.

6.3 Directory

6.3.1 Directory

 **Extension**

Jack no.	Extension no.	Name	Jack no.	Extension no.	Name
01-1			01-2		
02-1			02-2		
03-1			03-2		
04-1			04-2		
05-1			05-2		
06-1			06-2		
07-1			07-2		
08-1			08-2		
09-1			09-2		
10-1			10-2		
11-1			11-2		
12-1			12-2		
13-1			13-2		
14-1			14-2		
15-1			15-2		
16-1			16-2		
17-1			17-2		
18-1			18-2		
19-1			19-2		
20-1			20-2		
21-1			21-2		
22-1			22-2		
23-1			23-2		
24-1			24-2		
25-1			25-2		
26-1			26-2		
27-1			27-2		
28-1			28-2		
29-1			29-2		
30-1			30-2		
31-1			31-2		
32-1			32-2		

Jack no.	Extension no.	Name	Jack no.	Extension no.	Name
33-1			33-2		
34-1			34-2		
35-1			35-2		
36-1			36-2		
37-1			37-2		
38-1			38-2		
39-1			39-2		
40-1			40-2		
41-1			41-2		
42-1			42-2		
43-1			43-2		
44-1			44-2		
45-1			45-2		
46-1			46-2		
47-1			47-2		
48-1			48-2		
49-1			49-2		
50-1			50-2		
51-1			51-2		
52-1			52-2		
53-1			53-2		
54-1			54-2		
55-1			55-2		
56-1			56-2		
57-1			57-2		
58-1			58-2		
59-1			59-2		
60-1			60-2		
61-1			61-2		
62-1			62-2		
63-1			63-2		
64-1			64-2		

 **System Speed Dialling**

No.	Name	No.	Name	No.	Name
000		047		094	
001		048		095	
002		049		096	
003		050		097	
004		051		098	
005		052		099	
006		053		100	
007		054		101	
008		055		102	
009		056		103	
010		057		104	
011		058		105	
012		059		106	
013		060		107	
014		061		108	
015		062		109	
016		063		110	
017		064		111	
018		065		112	
019		066		113	
020		067		114	
021		068		115	
022		069		116	
023		070		117	
024		071		118	
025		072		119	
026		073		120	
027		074		121	
028		075		122	
029		076		123	
030		077		124	
031		078		125	
032		079		126	
033		080		127	
034		081		128	
035		082		129	
036		083		130	
037		084		131	
038		085		132	
039		086		133	
040		087		134	
041		088		135	
042		089		136	
043		090		137	
044		091		138	
045		092		139	
046		093		140	

	Name	No.	Name	No.	Name
141		188		235	
142		189		236	
143		190		237	
144		191		238	
145		192		239	
146		193		240	
147		194		241	
148		195		242	
149		196		243	
150		197		244	
151		198		245	
152		199		246	
153		200		247	
154		201		248	
155		202		249	
156		203		250	
157		204		251	
158		205		252	
159		206		253	
160		207		254	
161		208		255	
162		209		256	
163		210		257	
164		211		258	
165		212		259	
166		213		260	
167		214		261	
168		215		262	
169		216		263	
170		217		264	
171		218		265	
172		219		266	
173		220		267	
174		221		268	
175		222		269	
176		223		270	
177		224		271	
178		225		272	
179		226		273	
180		227		274	
181		228		275	
182		229		276	
183		230		277	
184		231		278	
185		232		279	
186		233		280	
187		234		281	

	Name	No.	Name	No.	Name
282		329		376	
283		330		377	
284		331		378	
285		332		379	
286		333		380	
287		334		381	
288		335		382	
289		336		383	
290		337		384	
291		338		385	
292		339		386	
293		340		387	
294		341		388	
295		342		389	
296		343		390	
297		344		391	
298		345		392	
299		346		393	
300		347		394	
301		348		395	
302		349		396	
303		350		397	
304		351		398	
305		352		399	
306		353		400	
307		354		401	
308		355		402	
309		356		403	
310		357		404	
311		358		405	
312		359		406	
313		360		407	
314		361		408	
315		362		409	
316		363		410	
317		364		411	
318		365		412	
319		366		413	
320		367		414	
321		368		415	
322		369		416	
323		370		417	
324		371		418	
325		372		419	
326		373		420	
327		374		421	
328		375		422	

	Name	No.	Name	No.	Name
423		449		475	
424		450		476	
425		451		477	
426		452		478	
427		453		479	
428		454		480	
429		455		481	
430		456		482	
431		457		483	
432		458		484	
433		459		485	
434		460		486	
435		461		487	
436		462		488	
437		463		489	
438		464		490	
439		465		491	
440		466		492	
441		467		493	
442		468		494	
443		469		495	
444		470		496	
445		471		497	
446		472		498	
447		473		499	
448		474			

◆◆ Station Speed Dialling

Name	No.	Name	No.
	0		5
	1		6
	2		7
	3		8
	4		9

6.4 What is This Tone?

6.4.1 What is This Tone?

While on-hook

Ring Tones

Tone 1

- Incoming call from an external party
- An outside call is held for more than a specified time (default: 60 seconds).



Tone 2

- Incoming call from an extension
- An intercom call is held for more than a specified time (default: 60 seconds).



Tone 3

- Incoming call from a doorphone
- The pre-set alarm time has arrived.

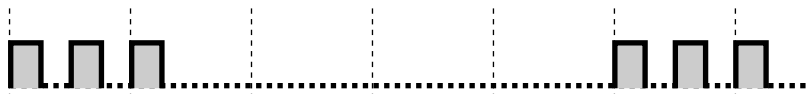

Tone 4

- A reserved outside line or extension became idle.
- A caller is leaving a message in your mailbox (Live Call Screening-Private mode).

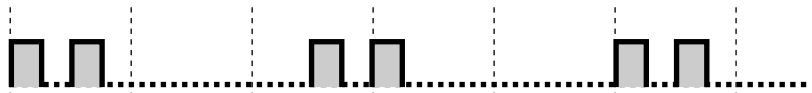

When going off-hook

Dial Tones

Tone 1

Normal



Tone 2

At least one feature has been changed from the default setting at your extension.

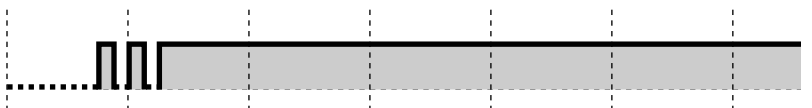

Tone 3

- The alarm is being answered.
- Enter an account code to turn off the tone.



Tone 4

Message waiting indication was received.

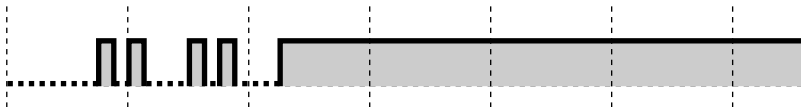

When you make calls

Busy Tone

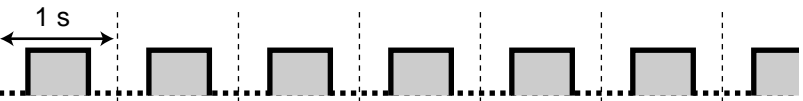

Reorder Tone

- The outside line you tried to seize is not assigned or denied.
- The wrong account code was entered.



Ringback Tone 1

Normal ringback tone



Ringback Tone 2

Special ringback tone for DISA call



Do Not Disturb Tone

The dialled extension is refusing incoming calls.

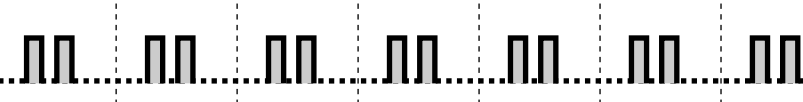

While off-hooking

Indication Tones

Tone 1

Call waiting tone (default)

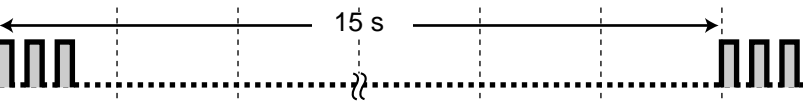

Tone 2

Call waiting tone from outside



Tone 3

Call waiting tone from another extension

**Tone 4**

A call is held for more than a specified time (default: 60 seconds)

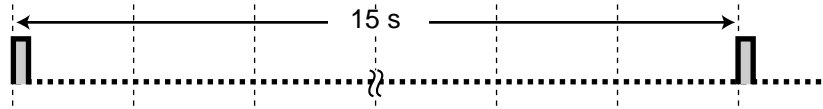
**When talking to an external party****Warning Tone**

This tone is sent 15, 10 and 5 seconds before the time limit.

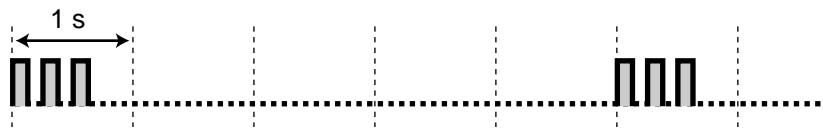
**When setting the features or programming****Confirmation Tones****Tone 1**

- Set/cancel to deny other people the possibility of using your phone.
- The new setting differs from the previous setting by personal programming.
- Completing the system programming.

**Tone 2**

- The feature setting was completed successfully.
- Before paging through an external speaker
- The new setting is same as the previous setting by personal programming.

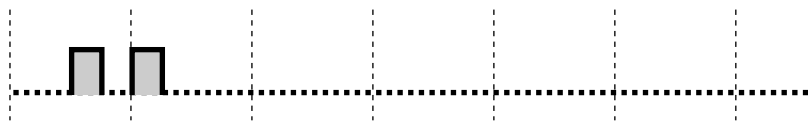
**Tone 3**

Before performing the following features:

- Retrieving a held call
- Picking up another call
- Paging/Answering a paged announcement
- Answering the call through a speaker



Tone 4

Establishing or leaving a three-party conversation



6.5 Specifications

6.5.1 Specifications

General Description

Item	Description			
	Basic	Expansion	System Connection	
System Capacity	KX-TD816			
	Outside lines	4	8	—
	Extension lines	8	16	—
	(Extension lines with XDP	16	32	—)
	KX-TD1232			
	Outside lines	8	12	24
Extension lines	16	32	64	
(Extension lines with XDP	32	64	128)	
Power Supplies	Primary	220-240 VAC, 50Hz / 60Hz		
	Secondary	Station Supply Volt : 30V Circuit Volt: $\pm 5V$, $\pm 15V$		
	Power Failure	<ul style="list-style-type: none"> Memory backup duration : seven years with a factory-provided lithium battery 4 outside lines max. for KX-TD816 and 6 outside lines max. for KX-TD1232 automatically assigned to stations (Power Failure Transfer) System operation for about three hours using recommended batteries (consisting of two 12 VDC car batteries) 		
Dialling	Outward/Internal Mode Conversion	Dial Pulse (DP) 10 pps, 20 pps, Tone (DTMF) Dialling DP-DTMF, DTMF-DP		
SMDR (Station Message Detail Recording)	Interface Output Equipment Detail Recording	Serial Interface (RS-232C) Printer Date, Time, Extension Number, Outside Line Number, Dialed Number, Ring Duration, Call Duration, Account Code, Charge Fee, Timed Reminder, CLIP		

Characteristics

Item	Description
Maximum Number of Station Instruments per Line	1 or 2 by Parallel or eXtra Device Port Connection
Ring Voltage	70 Vrms at 25 Hz depending on the ringing load
Environmental Requirements	0 - 40 °C, 10 - 90% relative humidity

A

Absent Message	72, 198
ABST MSG Off / Absent MSG Off	73, 74
ABST MSG On 1-9 / Absent MSG On (1-9)	73
ACCESS DECT-SYS	205
ACCNT	40
Account	40, 143, 146, 196, 209, 211, 232
Adding Telephone	14
Alarm	85, 199, 232
Alert	143
Alternate Calling - Ring / Voice	43, 196
ANSWER	22, 131
AUTO	174
AUTO ANS DELAY	205
AUTO ANSWER	22, 205
AUTO DIAL	22
Automatic-Answer Delay Selection	205
Automatic-Answer Mode Set	180, 205
Automatic-Callback Busy	35, 195
Automatic-Log	107
Automatic-Redial	33
Automatic-Route Selection	2, 27, 179

B

Back at %:% (Hour:Minute)	72
Background Music (BGM)	92, 127
BACKLIGHT	204
Battery	171
BGM	92, 93
BOOK	174
BOOK=NEXT	207
BSS (Busy Station Signalling) / BSS	36, 196
Busy	33, 35, 36, 67, 195, 196, 198
Busy Station Signalling (BSS)	36, 196
Busy tone	232
Button	22, 143, 144, 174, 194, 209

C

C.BCK	35
C.Pickup GRP / C.Pickup Group	49
C=EXIT	207
CALL	108
Call Forwarding	67, 121, 198, 200
Call Log	114, 117
Call Park	55, 197
Call Park 0-9 / Call Park (0-9).....	56
Call Pickup.....	49, 196
Call Pickup Deny	90, 143

Call Splitting	57, 197
Call Waiting	36, 60, 88, 143, 197, 199
Call Waiting-Tone	60, 101, 142, 232
Call-Directories	185
Call-Duration	40, 109
Caller ID	46
Call-Information	27, 46, 109, 179
Calling back	108
Calling Line Identification Presentation (CLIP)	89, 200
Calling Line Identification Restriction (CLIR)	143, 200
Calling method	43
Call-Record	2, 109
CANCEL	174
CANCEL DECT-SYS	206
Capacity	10, 235
Cell Station	171, 177, 178
Character	151, 190
Charge Fee Management	146, 211
Charger	171
Check in / Check out	132, 133
Check-in / check-out	132
Clearing-(Flexible) button data	145
Clearing-Programmes	96, 200
CLR	107, 136, 146, 148
CLR (CLEAR)	174
CO	21, 22, 143, 209
Completion of Calls to Busy Subscriber (CCBS)	196
Completion of Calls to Busy Subscriber / CCBS	196
CONF	143, 175, 194
CONF (KEY4)	194
Conference	62, 197, 209
Confirmation	18, 149, 233
Connected Line Identification Presentation (COLP)	89
Connected Line Identification Restriction (COLR)	143, 200
Connection	14
Customise	201

D

Data / Time Display	206
Data / Time Display Selection	206
Date	107, 154
Day / Night	94, 200
DECT System-Lock Password Set	206

Index

DECT System-Number 173
DECT System-Selection 205
DECT-SYS LOCK 206
Denying-Displaying your number on the
 called party's telephone 89, 200
Denying-Displaying your number on the
 calling party's telephone 89, 90
Denying-Joining your conversation .. 91, 200
Denying-Picking up your calls 200
Denying-Retrieving your held calls
 54, 110, 183
Denying-Ringing (DND) 87, 199
Denying-Using your telephone 75, 198
Department code 146, 211
Dial Tone 231
Direct Inward System Access (DISA)..... 44
Direct Outside Calls 199, 200
Directed Call Pickup-Directory 223
DIRECTORY LOCK 190, 205
Directory Lock Control 190, 205
Display 18, 19, 107, 111, 148, 170
Display feature list 119
Display Language Selection 205
DND (0*/ext) 87, 121
DND for DDI 143, 198
Do Not Disturb (DND)
 22, 41, 87, 121, 196, 199, 232
Do Not Disturb Override..... 41, 196
Door Open 98
Door Opener 97, 200
Doorphone 13, 97, 200, 231
Doorphone Call Forwarding to Outside Line
 143, 200
DSS 22, 25, 143, 209

E

Easy Dialling 28
Electronic Station Lockout 75, 198
Emergency call 27, 179
END 133, 136
Exclusive Call Hold 54, 183
Executive Busy Override 39, 196
Executive Busy Override Deny 91, 143, 200
EXT 112, 115
Ext-BGM On/Off / Extrn BGM On/Off 127
Extension 114, 117
Extension-Customise 140
Extension-Dialling 25, 112, 114, 117, 178
Extension-Directory 224

Extension-Group49, 79, 80, 196
Extension-Lock75, 124, 198
Extension-Name164
Extension-Number148, 163, 173, 208
External Feature Access99, 200
External Party26, 58, 67, 178, 197
External Relay200
External Ringer200
eXtra Device Port (XDP)14

F

Facsimile (FAX)13
FEAT112, 115
Feature Number18, 173, 220
Features114, 117
Flexible CO143, 174
Follow Me67, 198
Forwarding Calls67, 198
Full One-Touch Dialling141
Function22, 174
FWD/DND121, 143, 175, 194, 209
FWD/DND (KEY2)194
FWD/DND Cancel70
FWD-All Calls (ext)69, 100
FWD-BSY N/A (ext)69, 100
FWD-Busy (ext) 69, 100
FWD-CO Line (dial)69
FWD-From (ext) 69
FWD-No Answer (ext)69, 100

G

Gone Home72
Group Call Pickup 49
GUIDANCE206
Guidance Menu Set206

H

Handover177
Handset142
Handset Mute.....65
Hands-free Answerback48
Hands-free mode101, 142
Hands-free operation27, 46
Headset142
Hold (HOLD) 22, 52, 174, 182
HOLD=BACK207
Host PBX99, 200
Hotel132, 133, 136
Hotel Use Features132
Hurry-Up / Hurry-Up Transfer143

- I**
- Icon 3, 21, 149, 173
 - Identification number 89, 200
 - In a Meeting 72
 - Incoming Call Log 107, 110, 124
 - Indication Tone 38, 101, 196, 232
 - Initial Display 107
 - Initial Settings 141, 208
 - INTERCOM 22, 174
 - Intercom Alert 142
 - Intercom Call
..... 25, 112, 114, 115, 117, 142, 177, 231
- J**
- Jack number 148
 - Joining - An existing call 39
 - Joining - Receiving group 76, 198
- K**
- KEY 194
 - Key Click Tone 142
 - KEY TONE 204
 - Keypad Backlight Mode Set 204
 - KEYPAD LOCKED 193
- L**
- LANGUAGE 205
 - Last Number Redial 33, 181
 - Leaving-Conference 62, 197
 - Leaving-Message waiting indication 36
 - Leaving-Receiving group 76, 198
 - Letting a third party join your call 64
 - Line-Access number 26, 178
 - Line-Name 46, 107, 108
 - Line-Outside line 26, 178
 - Live Call Screening (LCS)
..... 101, 124, 142, 143, 231
 - Location 11
 - Lock 75, 124, 193, 198
 - Log 109
 - Log-In/Log-Out 76, 143, 198, 209
 - Loop-CO 22, 27, 143, 179, 209
- M**
- Mailbox 100, 200
 - Making Calls ... 111, 112, 116, 141, 177, 189
 - Making Calls-Account Codes 40, 41, 196
 - Making Calls-Call log 107, 116
 - Making Calls-Doorphone 97, 200
 - Making Calls-Easy Dialling 28
 - Making Calls-From the Outside 44
 - Making Calls-Phantom 31
 - MEMORY CLEAR 206
 - Memory Clear 206
 - MESSAGE 22, 143, 175, 194
 - Message 36, 72, 101, 128, 196, 198, 209
 - MESSAGE (KEY3) 194
 - Message Waiting 36, 196
 - Microphone 65
 - Microphone Mute 65
 - Minibar 133
 - MODIFY BOOK 185
 - MONITOR 22
 - Monitoring 101
 - MSG Off ext / Message Off (ext) 37
 - MSG On ext / Message On (ext) 37
 - Mute (MUTE) 22, 65
- N**
- Name 11
 - Name-Character Entering 151
 - Name-Extension 164
 - Name-Outside line 107, 108
 - Name-Station Speed Dialling 118
 - Name-System Speed Dialling 156
 - New 107
 - Night 143, 209
 - NO 133
 - No Answer 67, 100, 198
 - Notebook Function 197
- O**
- Off-Hook Call Announcement (OHCA)
..... 36, 60, 88
 - Off-Hook Monitor 66
 - OK 174
 - OK=OK 207
 - OLD 107
 - One-Touch Dialling ... 28, 141, 143, 195, 209
 - One-Touch Dialling with Auto Hold 143, 209
 - One-Touch Transfer 58
 - Opening the door 98, 200
 - Operator 26, 195
 - Others 133
 - Out until %/%/% (Month/Day) 72
 - Outgoing Call Log 114, 117, 181
 - Outgoing Message (OGM) 128, 137
 - Outgoing message(OGM) 44
 - Outside 26, 44, 49, 60, 67, 178, 196, 198

Index

Outside (CO) Call Pickup 49
Over 39, 41
Overlay 147

P

Page E-ANS 1-4 / Page-Ext Answer (1-4)
..... 51, 83
Page Extn 0-4 / Paging External (0-4) 79
Page GRP 00-16 / Paging Group (00-16)
..... 79, 80
Page-GRP ANS / Page-GRP Answer 83
Paging 78, 199, 233
Parallel 1/0 / Parallel On/Off (1/0) 95
Paralleled telephone 14, 95, 143
Password 102, 124, 147, 150
PAUSE 22, 175, 194
PAUSE (KEY1) 194
PBX Extension Dialling Directory ... 185, 189
PBX Programming 208
PBX Station Speed Dialling Directory
..... 185, 189
PBX System Speed Dialling Directory
..... 185, 189
PBX-EXT-DIALLING 189
PBX-PROGRAM 201
PBX-STA-DELETE 185
PBX-STA-DIALLING 189
PBX-STA-EDIT 185
PBX-SYS-DIALLING 189
Personal Computer 13
PF 143
Phantom 31, 143, 144
Picking up..... 49, 233
Pickup Dialling 30, 143, 195
Power Failure 235
Power Switch 174
Preferred Line 141, 208
Preferred Line Assignment 141
PRINT 133
Print out 2, 132
Private mode 104, 142, 231
PROG 136
PROGRAM 22
PROGRAMMING 201
Programming 141, 201
Proprietary Telephone 14, 18, 140
PS Dialling Directory 185, 189
PS PASSWORD 206
PS Programming 202

PS Programming Password Set206
PS Registration Cancellation206
PS-DELETE185
PS-DIALLING189
PS-EDIT185
PS-NEW-ENTRY185
PS-PASSWORD 203
PS-PROGRAM201
Pulse to Tone196

Q

QUICK ANSWER205
Quick Answering Mode Set180, 205
Quick Dialling 31, 195
Quick Dialling-Directory230

R

Radio Signal Strength171
RECALL (for PS)174, 177, 178
RECALL (for PT).....22, 33
Received group76, 143, 198
Receiving calls180
Receiving calls-Call waiting60, 88, 199
Receiving calls-Hands-free 46, 48
Receiving calls-Mailbox100, 101, 200
Receiving calls-Paging199
Recording-Call log2, 109
Recording-Conversation105, 200
Recording-Outgoing message128
Redial (REDIAL) . 23, 33, 114, 117, 174, 181
REGISTRATION201
Registration170
RELEASE23, 131
Remote Station Lock Control124
Reorder Tone..... 232
Reset button11
Restriction20, 40, 196, 200
Ring..... 43, 142, 144, 196, 231
RING PATTERN204
Ringer Pattern Selection204

S

Save (SAVE)143, 209
Saved Number Redial34, 195
Saving a number197
SECRET144, 155, 210
SEL146
SELECT23, 151
SHIFT23
Single line telephone13, 14, 18, 95

-
- Speaker 13, 51, 78, 199
- SP-PHONE 21
- STA 112, 115
- STA Speed 114, 115, 117
- STANDBY DISPLAY 205
- Standby Display Selection 205
- Station Message Detail Recording (SMDR)
..... 2, 146, 211, 235
- Station Program Clear 200
- Station Programme Clear 96
- Station speed dialling
..... 28, 112, 114, 115, 117, 118, 195
- Station speed dialling-Directory 229
- STORE 22
- Super EXtra Device Ports (SXDP) 192
- SYS Speed 114, 115, 117
- System Feature Access .. 112, 114, 115, 117
- System speed dialling
..... 29, 112, 114, 115, 117, 155, 156, 195
- System speed dialling-Directory 226
- T**
- TALK 174
- Telephone 2, 13, 18, 22, 133
- Terminate 143, 209
- Three-party Conversation 197, 234
- Time 107, 154
- Time Limit 233
- Timed Reminder 85, 199
- Tone 43
- TONE (KEY5) 194
- Tone (TONE) 41, 173, 196
- TRANSFER 23, 174
- Transferring 58, 81, 101, 184, 197
- Troubleshooting 214
- Trunk Answer From Any Station (TAFAS)
..... 51, 196
- Two-Way Recording 105, 143, 200, 209
- Two-Way Transfer 106, 143, 209
- U**
- Unattended Conference 62, 197
- Unlock 75, 110, 124, 198
- V**
- VIBRATION & RING 204
- Vibration and Ring Type Selection 204
- Voice..... 43
- Voice mail 2, 100, 142, 143, 200, 209
- Voice processing system 2, 13, 100
- Voice-Calling 196
- Volume Control 174
- W**
- Wake up / Wake-Up call 136
- Warning Tone 233
- Whisper OHCA 36, 60, 88
- Will Return Soon 72
- Y**
- YES 133

Please cut out these cards and distribute to the single line telephone users.

Quick Reference Card

To Make Calls

- Intercom: Ext. no.
- Operator: 0
- External Party: (9 or 81-88) + Phone no.
- Station Speed Dialling: 3 X + No. 0-9
- System Speed Dialling: X + No. 000-499
- Doorphone: 3 1 + No. 1-4







When a Line is Busy

- Reserving a busy line: 6
- Sending a call waiting tone: 1
- Redialling the last dialled number: #

To Pick Up Someone's Call

- Outside Call: 4 X
- Specified Extension: 4 1 + Ext. no.
- Extension Group: 4 0

During a Conversation

- Holding:  + 5 0 + 
- Retrieving:  + 5 0
- Transferring:  + Dial no.
- Answering Call Waiting:  + 5 0 +  + 

Quick Reference Card

To Make Calls

- Intercom: Ext. no.
- Operator: 0
- External Party: (9 or 81-88) + Phone no.
- Station Speed Dialling: 3 X + No. 0-9
- System Speed Dialling: X + No. 000-499
- Doorphone: 3 1 + No. 1-4







When a Line is Busy

- Reserving a busy line: 6
- Sending a call waiting tone: 1
- Redialling the last dialled number: #

To Pick Up Someone's Call

- Outside Call: 4 X
- Specified Extension: 4 1 + Ext. no.
- Extension Group: 4 0

During a Conversation

- Holding:  + 5 0 + 
- Retrieving:  + 5 0
- Transferring:  + Dial no.
- Answering Call Waiting:  + 5 0 +  + 

Quick Reference Card

To Make Calls

- Intercom: Ext. no.
- Operator: 0
- External Party: (9 or 81-88) + Phone no.
- Station Speed Dialling: 3 X + No. 0-9
- System Speed Dialling: X + No. 000-499
- Doorphone: 3 1 + No. 1-4







When a Line is Busy

- Reserving a busy line: 6
- Sending a call waiting tone: 1
- Redialling the last dialled number: #

To Pick Up Someone's Call

- Outside Call: 4 X
- Specified Extension: 4 1 + Ext. no.
- Extension Group: 4 0

During a Conversation

- Holding:  + 5 0 + 
- Retrieving:  + 5 0
- Transferring:  + Dial no.
- Answering Call Waiting:  + 5 0 +  + 

Quick Reference Card

To Make Calls

- Intercom: Ext. no.
- Operator: 0
- External Party: (9 or 81-88) + Phone no.
- Station Speed Dialling: 3 X + No. 0-9
- System Speed Dialling: X + No. 000-499
- Doorphone: 3 1 + No. 1-4







When a Line is Busy

- Reserving a busy line: 6
- Sending a call waiting tone: 1
- Redialling the last dialled number: #

To Pick Up Someone's Call

- Outside Call: 4 X
- Specified Extension: 4 1 + Ext. no.
- Extension Group: 4 0

During a Conversation

- Holding:  + 5 0 + 
- Retrieving:  + 5 0
- Transferring:  + Dial no.
- Answering Call Waiting:  + 5 0 +  + 

Please cut out these cards and distribute to the single line telephone users.

Locking / Unlocking Your Phone

- Lock: 7 7 + 3-digit desired code + same code
- Unlock: 7 7 + Stored code

Settings

- Storing the number for Station Speed Dialling:
3 0 + No. 0-9 + Line no. 9 or 81-88 + Phone no. + #
- Call Waiting:
— Set: 7 3 1 1
— Cancel: 7 3 1 0

Frequently Used Features at Your Extension

Locking / Unlocking Your Phone

- Lock: 7 7 + 3-digit desired code + same code
- Unlock: 7 7 + Stored code

Settings

- Storing the number for Station Speed Dialling:
3 0 + No. 0-9 + Line no. 9 or 81-88 + Phone no. + #
- Call Waiting:
— Set: 7 3 1 1
— Cancel: 7 3 1 0

Frequently Used Features at Your Extension

Locking / Unlocking Your Phone

- Lock: 7 7 + 3-digit desired code + same code
- Unlock: 7 7 + Stored code

Settings

- Storing the number for Station Speed Dialling:
3 0 + No. 0-9 + Line no. 9 or 81-88 + Phone no. + #
- Call Waiting:
— Set: 7 3 1 1
— Cancel: 7 3 1 0

Frequently Used Features at Your Extension

Locking / Unlocking Your Phone

- Lock: 7 7 + 3-digit desired code + same code
- Unlock: 7 7 + Stored code

Settings







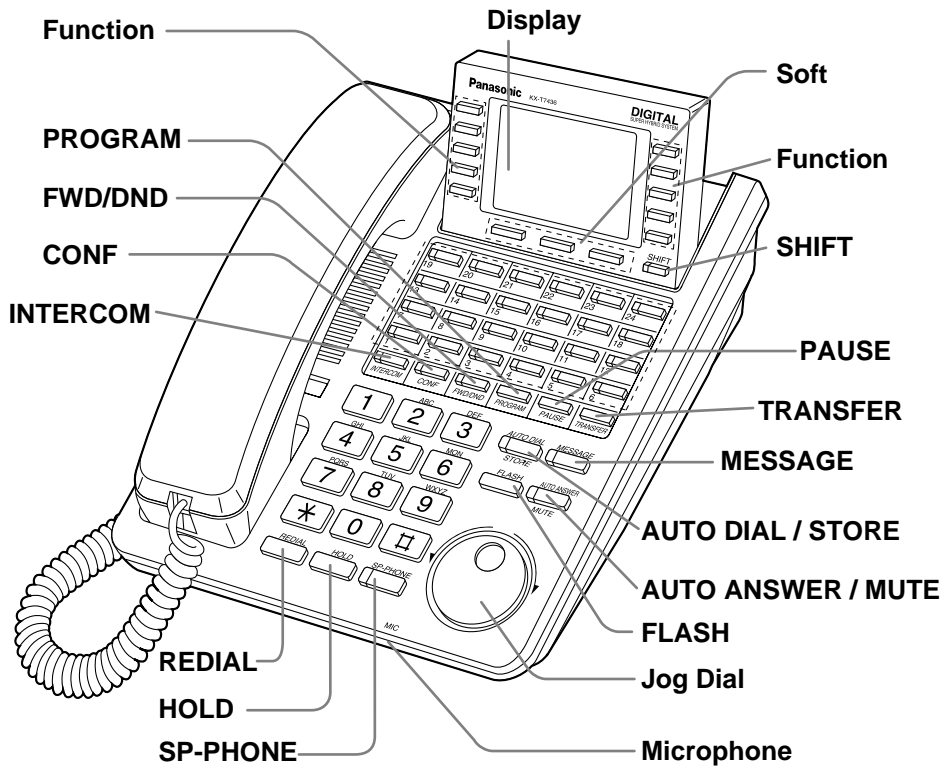





- Storing the number for Station Speed Dialling:
3 0 + No. 0-9 + Line no. 9 or 81-88 + Phone no. + #
- Call Waiting:
— Set: 7 3 1 1
— Cancel: 7 3 1 0

Frequently Used Features at Your Extension

◆◆ Names and Locations of the KX-T7436



◆◆ Icons

	Conditions		Press the Call button on the Doorphone.
	Hints		Press the hookswitch lightly.
	Related Programming Title or Programming steps.		Wait for an answer.
	Not available for a single line telephone.		Talk.
	Off-hook.		You will hear a confirmation, dial, ring or ringback tone. C. Tone: confirmation tone D. Tone: dial tone R. Tone: ring tone R. B. Tone: ringback tone
	On-hook.		One short beep

Copyright:

This manual is copyrighted by Kyushu Matsushita Electric Co., Ltd. (KME).
Under the copyright laws, this manual may not be reproduced in any form, in whole or part,
without the prior written consent of KME.

© Kyushu Matsushita Electric Co., Ltd. 1999

Kyushu Matsushita Electric Co., Ltd.

1-62, 4-chome, Minoshima, Hakata-ku, Fukuoka 812-8531, Japan